MicroMaxx[®] Ultrasound System



User Guide

CE
0086

MicroMaxx Ultrasound System

User Guide

SonoSite, Inc.

21919 30th Drive SE

Bothell, WA 98021

USA

T: 1-888-482-9449 or 1-425-951-1200

F: 1-425-951-1201

SonoSite Ltd

Alexander House

40A Wilbury Way

Hitchin

Herts SG4 0AP

UK

T: +44-1462-444800

F: +44-1462-444801

Caution: | Federal (United States) law restricts this device to sale by or on the order of a physician.

MicroMaxx, SiteLink, SonoCalc, SonoMB, SonoRES, and SonoSite are registered trademarks or trademarks of SonoSite, Inc.

CompactFlash is a registered trademark of Symbol Technologies.

DICOM is the registered trademark of the National Electrical Manufacturers Association for its standards publications relating to digital communications of medical information.

Non-SonoSite product names may be trademarks or registered trademarks of their respective owners.

The SonoSite product(s) referenced in this document may be covered by one or more of the following patents: 5722412, 5817024, 5893363, 6135961, 6203498, 6364839, 6371918, 6383139, 6416475, 6447451, 6471651, 6569101, 6648826, 6575908, 6604630, 6817982, 6835177, 6962566, 7169108, D456509, D461895, D509900, D538432, D544962, D558351, D559390. Patents pending. Other international patents may also apply.

P06435-07 07/2008

Copyright 2008 by SonoSite, Inc.

All rights reserved.

Contents

Introduction 1

About the User Guide	1
Intended Uses	1
Conventions	4
Symbols and Terms	4
Upgrades and User Guide Updates	4
Customer Comments	4
Contact Information	5
About the System	6
About the System Software	8

Getting Started 9

Healthy Scanning Guidelines	9
System Preparation	11
Installing or Removing Battery	11
Installing or Removing CompactFlash Card	12
Using AC Power/Charging Battery	13
Turning System On/Off	14
Connecting or Removing Transducer	15
System Controls	16
Screen Layout	19
General Interaction	20
Touchpad	20
On-Screen Menus	21
Menu Controls	21
Annotation and Text	22
Forms	23
System Setup	24
Set Security Settings	25
Audio and Battery	31
Cardiac Calculations	32
Connectivity	33
Date and Time	35
Delta Key and Annotation	36
Display Information	38
IMT Calculations	39
OB Calculations Authors	40
OB Custom Measurements	42
OB Custom Tables	43
Presets	45
System Information	47
Network Status	48

Imaging 49

- Patient Information 49
- Transducer, Exam Type, and Imaging Mode 52
- Transducer Preparation 55
 - General Use 56
 - Invasive or Surgical Use 56
- Modes 57
 - 2D Imaging 57
 - M Mode Imaging 61
 - Color Doppler Imaging 63
 - Pulsed Wave (PW) and Continuous Wave (CW) Doppler Imaging 65
- Clips 68
 - Clip Acquisition Delay 69
- Image and Clip Storage 70
 - Save to CompactFlash 70
 - Print to Local Printer 72
- Image and Clip Review 72
 - Patient List 72
 - Patient Images and Clips 73
- Annotations 74
- ECG Monitoring 76
- Footswitch 77
- Bar Code Scanner 78
- Needle Guidance 78

Measurements and Calculations 79

- Measurements 79
 - 2D Measurements 79
 - M Mode Measurements 83
 - Doppler Measurements 85
- Calculations 89
 - Percent Reduction Calculations 90
 - Volume Calculation 92
 - Volume Flow Calculation 94
 - Small Parts Calculations 96
 - Gyn Calculations 97
 - OB Calculations 100
 - Vascular Calculations 108
 - IMT Calculations 110
 - Transcranial Doppler Calculations (TCD) 114
 - Cardiac Calculations 117
- Patient Report 135

Connectivity and Configuration 141

- System Connectivity Setup 141

- System Configuration for SiteLink 141
 - Configuring SiteLink for Ethernet 142
 - Configuring SiteLink for Wireless 143
- System Configuration for DICOM 147
 - Creating Backup for DICOM Settings 147
 - Configuring Locations 148
 - Configuring Archivers 154
 - Configuring Printers 157
 - Configuring Worklist Servers 161
 - Configuring Procedures 164
 - Importing and Exporting Configurations 165
 - Reviewing the Network Log 166
- DICOM Usage 167
 - DICOM Image Archive and Print 169
 - Patient Information 171
 - DICOM Worklists 172

Troubleshooting and Maintenance 175

- Troubleshooting 175
- Software Licensing 177
 - Upgrading the System and Transducer Software 177
 - Upgrading Triple Transducer Connect (TTC) 183
- Obtaining a License Key 184
- Installing a License Key 185
- Maintenance 186
 - Recommended Disinfectant 186
 - Safety 186
 - Cleaning and Disinfecting Ultrasound System 187
 - Cleaning and Disinfecting Transducers 188
 - Sterilizing Transducers 190
 - Cleaning and Disinfecting Transducer Cables 190
 - Cleaning and Disinfecting Battery 192
 - Cleaning Footswitch 192
 - Cleaning and Disinfecting ECG Cables 192

References 201

- Display Size 201
- Caliper Placement 201
- 2D Measurements 201
- Sources of Measurement Errors 203
- Acquisition Error 203
- Algorithmic Error 203
- Terminology and Measurement Publications 203
- Cardiac References 204
- Obstetrical References 210
 - Gestational Age Tables 211

Growth Analysis Tables 214
Ratio Calculations 215
General References 216

Specifications 219

System Dimensions 219
Display Dimensions 219
Transducers 219
Imaging Modes 220
Image Storage 220
Accessories 220
 Hardware, Software, and Documentation 220
 Cables 221
Peripherals 221
Temperature and Humidity Limits 221
Electrical 222
Battery 222
Electromechanical Safety Standards 222
EMC Standards Classification 223
Airborne Equipment Standards 223
DICOM Standard 223
HIPAA Standard 223

Safety 225

Ergonomic Safety 225
Electrical Safety Classification 225
Electrical Safety 226
Equipment Safety 228
Battery Safety 228
Biological Safety 230
Electromagnetic Compatibility (EMC) 230
 Manufacturer's Declaration 232
The ALARA Principle 235
 Applying ALARA 235
 Direct Controls 236
 Indirect Controls 236
 Receiver Controls 236
Acoustic Artifacts 236
Guidelines for Reducing MI and TI 237
Output Display 239
 Mechanical and Thermal Indices Output Display Accuracy 240
 Factors that Contribute to Display Uncertainty 240
 Related Guidance Documents 241
Transducer Surface Temperature Rise 242
Acoustic Output Measurement 243
 In Situ, Derated, and Water Value Intensities 243

Tissue Models and Equipment Survey 244
About the Acoustic Output Table 245
Acoustic Output Tables 246
Acoustic Measurement Precision and Uncertainty 283
Labeling Symbols 283

Glossary 287

Terms 287
Acronyms 289

Chapter 1: Introduction

Please read the information in this user guide before using the SonoSite® MicroMaxx® ultrasound system. It applies to the ultrasound system and transducers.

About the User Guide

The *MicroMaxx Ultrasound System User Guide* provides information on preparing and using the ultrasound system, on upgrading the system and transducers, and on cleaning and disinfecting the system and transducers. It also provides references for calculations, system specifications, and additional safety and acoustic output information.

The *MicroMaxx Quick Start Cards*, located in the back of the user guide, provide an overview of basic system functions.

The user guide is designed for a reader familiar with ultrasound techniques; it does not provide training in sonography or clinical practices. Before using the system, you must have ultrasound training.

See the applicable SonoSite accessory user guide for information on using accessories and peripherals. See the manufacturers' instructions for specific information about peripherals.

Intended Uses

The intended uses for each exam type are contained here. See the intended transducer for exam type in [Table 2, "Transducer, Exam Type, and Imaging Mode"](#) on page 53.

Abdominal Imaging Applications

This system transmits ultrasound energy into the abdomen of patients using 2D, M Mode, color Doppler (Color), color power Doppler (CPD), Tissue Harmonic Imaging (THI), and pulsed wave (PW) Doppler to obtain ultrasound images. The liver, kidneys, pancreas, spleen, gallbladder, bile ducts, transplanted organs, abdominal vessels, and surrounding anatomical structures can be assessed for the presence or absence of pathology transabdominally.

Cardiac Imaging Applications

This system transmits ultrasound energy into the thorax of patients using 2D, M Mode, color Doppler (Color), Tissue Harmonic Imaging (THI), pulsed wave (PW) Doppler, pulsed wave tissue Doppler (TDI PW), and continuous wave (CW) Doppler to obtain ultrasound images. The heart, cardiac valves, great vessels, surrounding anatomical structures, overall cardiac performance, and heart size can be assessed for the presence or absence of pathology.

The patient's electrocardiogram (ECG) may be obtained and is used for timing of diastolic and systolic function.

WARNING: The ECG is not used to diagnose cardiac arrhythmias and is not designed for long term cardiac rhythm monitoring.

Gynecology and Infertility Imaging Applications

This system transmits ultrasound energy in the pelvis and lower abdomen using 2D, M Mode, color power Doppler (CPD), color Doppler (Color), Tissue Harmonic Imaging (THI), and pulsed wave (PW) Doppler to obtain ultrasound images. The uterus, ovaries, adnexa, and surrounding anatomical structures can be assessed for the presence or absence of pathology transabdominally or transvaginally.

Interventional and Intraoperative Imaging Applications

This system transmits ultrasound energy into the various parts of the body using 2D, color Doppler (Color), color power Doppler (CPD), Tissue Harmonic Imaging (THI), and pulsed wave (PW) Doppler to obtain ultrasound images that provide guidance during interventional and intraoperative procedures. This system can be used to provide ultrasound guidance for biopsy and drainage procedures, vascular line placement, peripheral nerve blocks, spinal nerve blocks and taps, ova harvesting, amniocentesis and other obstetrical procedures, and provide assistance during abdominal, breast, neurological surgery, and vascular intraoperative procedures.

Obstetrical Imaging Applications

This system transmits ultrasound energy into the pelvis of pregnant women using 2D, M Mode, color Doppler (Color), color power Doppler (CPD), Tissue Harmonic Imaging (THI), and pulsed wave (PW) Doppler to obtain ultrasound images. The fetal anatomy, viability, estimated fetal weight, gestational age, amniotic fluid, and surrounding anatomical structures can be assessed for the presence or absence of pathology transabdominally or transvaginally. CPD and color Doppler (Color) imaging is intended for high-risk pregnant women. High-risk pregnancy indications include, but are not limited to, multiple pregnancy, fetal hydrops, placental abnormalities, as well as maternal hypertension, diabetes, and lupus.

WARNING: To prevent injury or misdiagnosis do not use this system for Percutaneous Umbilical Blood Sampling (PUBS) or *in vitro* Fertilization (IVF) The system has not been validated to be proven effective for these two uses.

CPD or Color images can be used as an adjunctive method, not as a screening tool, for the detection of structural anomalies of the fetal heart and as an adjunctive method, not as a screening tool for the diagnosis of Intrauterine Growth Retardation (IUGR).

Pediatric Imaging Applications

This system transmits ultrasound energy into the pediatric patients using 2D, M Mode, color Doppler (Color), color power Doppler (CPD), pulsed wave (PW) Doppler, pulsed wave tissue Doppler (TDI PW), and continuous wave (CW) Doppler to obtain ultrasound images. The pediatric abdominal, pelvic and cardiac anatomy, pediatric hips, neonatal head, and surrounding anatomical structures can be assessed for the presence or absence of pathology.

Prostate Imaging Applications

This system transmits ultrasound energy into the prostate of an adult male using 2D, M Mode, color power Doppler (CPD), color Doppler (Color), and pulsed wave (PW) Doppler to obtain ultrasound images. The prostate gland can be assessed for the presence or absence of pathology.

Superficial Imaging Applications

This system transmits ultrasound energy into various parts of the body using 2D, M Mode, color Doppler (Color), color power Doppler (CPD), and pulsed wave (PW) Doppler to obtain ultrasound images. The breast, thyroid, testicle, lymph nodes, hernias, musculoskeletal structures, soft tissue structures, and surrounding anatomical structures can be assessed for the presence or absence of pathology. This system can be used to provide ultrasound guidance for biopsy and drainage procedures, vascular line placement, peripheral nerve blocks, and spinal nerve blocks and taps.

Transcranial Imaging Applications

This system transmits ultrasound energy into the cranium using 2D, color Doppler (Color), color power Doppler (CPD), and pulsed wave (PW) Doppler to obtain ultrasound images. The anatomical structures and vascular anatomy of the brain can be assessed for presence or absence of pathology. Two exam types support transcranial imaging: TCD and Orb. Imaging can be used temporally, trans-occipitally, or trans-orbitally.

WARNING: To avoid injury to the patient, use only an orbital exam type (Orb) when performing imaging through the eye. The FDA has established lower acoustic energy limits for ophthalmic use. The system will not exceed these limits only if the Orb exam type is selected.

Vascular Imaging Applications

This system transmits ultrasound energy into the various parts of the body using 2D, M Mode, color Doppler (Color), color power Doppler (CPD), and pulsed wave (PW) Doppler to obtain ultrasound images. The carotid arteries, deep veins, and arteries in the arms and legs, superficial veins in the arms and legs, great vessels in the abdomen, and various small vessels feeding organs can be assessed for the presence or absence of pathology.

Conventions

These conventions are used in this user guide:

- A **WARNING** describes precautions necessary to prevent injury or loss of life.
- A **Caution** describes precautions necessary to protect the products.
- Numbered steps in the procedures must be performed in a specific order.
- Bulleted lists present information in list format but do not imply a sequence.
- The system handle is on the front of the system, and the battery compartment is on the back of the system.

Symbols and Terms

Symbols and terms used on the system and transducer are explained in [Chapter 2, "Getting Started"](#); [Chapter 5, "Connectivity and Configuration"](#); ["Glossary" on page 287](#); and [Chapter 9, "Safety."](#)

Upgrades and User Guide Updates

SonoSite may offer software upgrades, new features, and improvements to the system performance. User guide updates accompany the upgrade software and provide detailed information on the enhancements.

Customer Comments

Questions and comments are encouraged. SonoSite is interested in your feedback regarding the system and the user guide. Please call SonoSite at **1-888-482-9449**. If you are outside the USA, call the nearest SonoSite representative. You can also e-mail SonoSite at **comments@sonosite.com**.

Contact Information

For SonoSite technical support, contact us at the following numbers or addresses:

Technical Support (USA, Canada):	1-877-657-8118
Technical Support fax:	1-425-951-6700
Technical Support e-mail:	service@sonosite.com
SonoSite website:	www.sonosite.com and select Support
International Technical Support:	Contact your local representative or call (USA) +425-951-1330
Europe Service Center:	+44-(0)1462-444-800 e-mail: uk.service@sonosite.com

About the System

The ultrasound system is a portable, software-controlled, ultrasound system using all-digital architecture. The system has multiple configurations and feature sets used to acquire and display high-resolution, real-time ultrasound images. All are described in this user guide but not every option may apply to your system. Features are dependent on system configuration, transducer, and exam type.

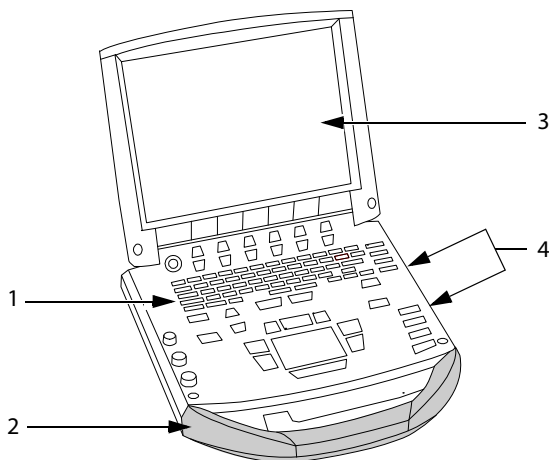

Figure 1 System Front View

Table 1: System Front Features

Number	Feature
1	Control panel
2	Handle
3	Display
4	CompactFlash® slots: front for image storage, back for system and transducer updates, import/export OB tables, custom annotations, and user names/passwords, and Digital Imaging and Communications in Medicine (DICOM®) configurations

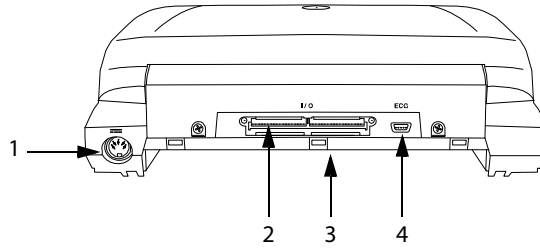

Figure 2 System Back View

Table 2: System Back Connectors

Number	Feature
1	DC input connector
2	I/O connector
3	Battery
4	ECG connector

Currently, the system supports the following transducers:

- C11e/8-5 MHz
- C60e/5-2 MHz
- D2/2 MHz
- HFL38/13-6 MHz
- ICT/8-5 MHz
- LAP/12-5 MHz
- L25e /13-6 MHz
- L38e/10-5 MHz
- P10/8-4 MHz
- P17/5-1 MHz
- SLA/13-6 MHz
- SLT/10-5 MHz
- TEE/8-3 MHz

The ultrasound system may include one or more of the following docking systems:

- Mobile Docking System enhanced (MDSe)
- Mobile Docking System (MDS)
- MDS Lite

See the applicable SonoSite accessory user guide. See [Chapter 8, “Specifications”](#) for a complete list of all system accessories.

System peripherals include medical grade (conforming to the requirements of EN60601-1) and non-medical (commercial) grade products. See [Chapter 8, “Specifications”](#) for a complete list of compatible peripherals. System setup instructions for the use of peripherals are covered in [“System Setup”](#) on page 24.

Manufacturer’s instructions accompany each peripheral. Instructions for the use of accessories and peripherals with the system are covered in the applicable SonoSite accessory user guide.

About the System Software

The ultrasound system contains software that controls its operation. A software upgrade may be required. SonoSite provides you with a CompactFlash card containing the software. Typically new software provides new capabilities. A single CompactFlash card can be used to update one or more systems. Software upgrades use the back CompactFlash slot on the right hand side of the system. CompactFlash cards installed in the front CompactFlash slot do not upgrade the system.

Chapter 2: Getting Started

This chapter contains information on healthy scanning practices, basic operation, and changing system settings.

Healthy Scanning Guidelines

These guidelines are intended to assist you in the comfort and effective use of your ultrasound system.

WARNING: Use of an ultrasound system may be linked to musculoskeletal disorders^{a,b,c}.

Use of an ultrasound system is defined as the physical interaction between the operator, the ultrasound system, and the transducer.

When using an ultrasound system, as with many similar physical activities, you may experience occasional discomfort in your hands, fingers, arms, shoulders, eyes, back, or other parts of your body. However, if you experience symptoms such as constant or recurring discomfort, pain, throbbing, aching, tingling, numbness, burning sensation, or stiffness, do not ignore these warning signs. Promptly see a qualified health professional. Symptoms such as these can be linked with musculoskeletal disorders (MSDs). MSDs can be painful and may result in potentially disabling injuries to the nerves, muscles, tendons, or other parts of the body. Examples of MSDs include carpal tunnel syndrome and tendonitis.

While researchers are not able to definitively answer many questions about MSDs, there is a general agreement that certain factors are associated with their occurrence including: preexisting medical and physical conditions, overall health, equipment and body position while doing work, frequency of work, duration of work, and other physical activities that may facilitate the onset of MSDs^d. This chapter provides guidelines that may help you work more comfortably and may reduce your risk of MSDs^{e,f}.

- a. Magnavita, N., L. Bevilacqua, P. Mirk, A. Fileni, and N. Castellino. "Work-related Musculoskeletal Complaints in Sonologists." *Occupational Environmental Medicine*. 41:11 (1999), 981-988.
- b. Craig, M. "Sonography: An Occupational Hazard?" *Journal of Diagnostic Medical Sonography*. 3 (1985), 121-125.
- c. Smith, C.S., G.W. Wolf, G. Y. Xie, and M. D. Smith. "Musculoskeletal Pain in Cardiac Ultrasonographers: Results of a Random Survey." *Journal of American Society of Echocardiography*. (May 1997), 357-362.
- d. Wihlidal, L.M. and S. Kumar. "An Injury Profile of Practicing Diagnostic Medical Sonographers in Alberta." *International Journal of Industrial Ergonomics*. 19 (1997), 205-216.
- e. Habes, D.J. and S. Baron. "Health Hazard Report 99-0093-2749." *University of Medicine and Dentistry of New Jersey*. (1999).
- f. Vanderpool, H.E., E.A. Friis, B.S. Smith, and K.L. Harms. "Prevalence of Carpal Tunnel Syndrome and Other Work-related Musculoskeletal Problems in Cardiac Sonographers." *Journal of Medicine*. 35:6 (1993), 605-610.

Position the System

Promote comfortable shoulder, arm, and hand postures:

- Use a stand to support the weight of the ultrasound system.

Minimize eye strain:

- When the exam/procedure allows, position the system within reach.
- Adjust the angle of the system/display to minimize glare from overhead or outside lighting.

Minimize neck strain:

- If using a stand, adjust the stand height such that the display is at or slightly below eye level.

Position Yourself

Support your back during an exam:

- Use a chair that has support for your lower back.
- Use a chair that adjusts to your work surface height and promotes a natural body posture.
- Use a chair that allows for quick height adjustments.
- Always sit or stand in an upright manner. Avoid bending or stooping.

Minimize reaching and twisting:

- Use a bed that is height adjustable.
- Position the patient as close to you as possible.
- Face forward. Avoid twisting your head or body.
- Move your entire body front to back and position your scanning arm next to or slightly in front of you.
- Stand for difficult exams to minimize reaching.

Promote comfortable shoulder and arm postures for your scanning arm:

- Keep your elbow close to your side.
- Relax your shoulders in a level position.
- Support your arm using a support cushion or pillow, or rest it on the bed.

Minimize neck bending and twisting:

- Position the ultrasound system/display directly in front of you.
- Provide an auxiliary monitor for patient viewing.

Promote comfortable hand, wrist, and finger postures for your scanning arm:

- Hold the transducer lightly in your fingers.
- Minimize the pressure applied on the patient.
- Keep your wrist in a straight position.

Take Breaks

Minimizing scanning time and taking breaks can be very effective in allowing your body to recover from physical activity, which can help you avoid any MSDs. Some ultrasound tasks may require longer or more frequent breaks. One way of taking a break is to stop and relax. However, simply changing tasks can help some muscle groups relax while others remain or become active.

Vary your daily activities:

- Plan your work so there are breaks in between ultrasound exams.
- Work efficiently when performing an ultrasound exam by using the software and hardware features correctly. Learn more about these features in [Chapter 3](#) of this guide.
- Keep moving. Avoid sustaining the same posture by varying your head, neck, body, arm, and leg positions.

Exercise

Targeted exercises can strengthen muscle groups, which may help you avoid MSDs. Contact a qualified health professional to determine stretches and exercises that are right for you.

System Preparation

Installing or Removing Battery

The battery comprises six lithium-ion cells plus electronics, a temperature sensor, and battery contacts.

- WARNING:** To avoid injury to the operator and to prevent damage to the ultrasound system, inspect the battery for leaks prior to installing.
- To avoid data loss and conduct a safe system shutdown, always keep a battery in the system.

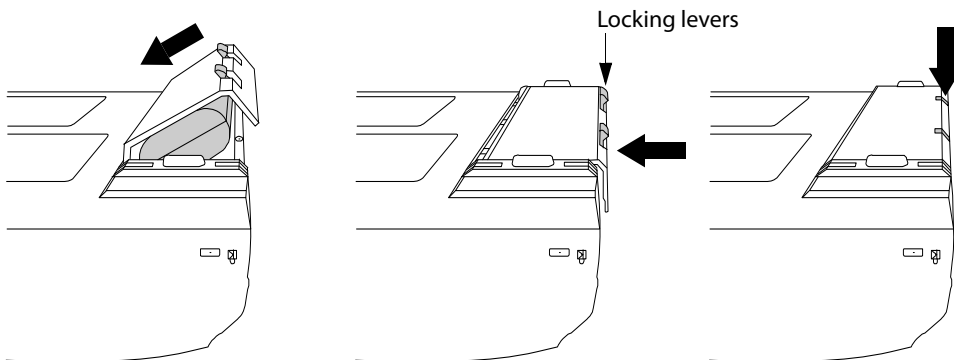

Figure 1 Insert Battery into System

Install Battery	1	Disconnect the power supply from the ultrasound system.
	2	Turn the system upside down.
	3	Place the battery into the battery compartment, at a slight angle. See Figure 1 on page 11.
	4	Slide the battery forward until it locks into place.
	5	Push down on the two locking levers to secure the battery.

Remove Battery	1	Push up on the two locking levers.
	2	Slide the battery back.
	3	Lift the battery from the compartment.

Installing or Removing CompactFlash Card

Images and clips are saved to a CompactFlash card and are organized in a patient list. The images and clips in the patient list are organized alphabetically by the patient name and ID. Images and clips are archived from the ultrasound system to a PC using a USB, Ethernet connection, wireless, or CompactFlash card. Images and clips on the CompactFlash card cannot be viewed directly from a CompactFlash reader.

Install CompactFlash Card	1	Verify the ejector pin is pushed in completely.
	2	Insert the CompactFlash card into the front slot on the ultrasound system. See Figure 1 on page 6. <ul style="list-style-type: none"> • The front slot is used to store images. • The back slot is used to update systems/transducers and to import/export DICOM configuration information, OB Tables, and annotation labels. • The CompactFlash card is ready to use when the save icon and the image and clip counters are displayed on the screen.

Caution: If the CompactFlash icon and image and clip counters are not displayed in the system status, the CompactFlash card may be defective. Turn the system off and replace the CompactFlash card.
The CompactFlash card may be restored if it is formatted on a PC. Formatting the card erases all data. If the card is physically damaged, formatting will not restore it.

WARNING: To prevent loss of data, (for example, images/clips), or damage to the CompactFlash card, always turn off the ultrasound system before removing the CompactFlash card.

-
- | | | |
|--------------------------|---|---|
| Remove | 1 | Turn off the ultrasound system before removing the card. |
| CompactFlash Card | 2 | Press the ejector pin in the front card slot to position it to the outside of the system. See Figure 1 on page 6. |
| | 3 | Push in the ejector pin to eject the CompactFlash card. |
| | 4 | Remove the card. |
| | 5 | Push in the ejector pin to avoid damaging the ejector pin. |

Using AC Power/Charging Battery

The battery charges when the system is connected to the AC power supply.

- If the system is off or in the sleep state (display off), a completely discharged battery fully charges in 2.5 to 3.5 hours.
- If the system is on and in the freeze state, a completely discharged battery fully charges in 5 to 6 hours.
- If the system is in the imaging state, the battery is trickle charged at a very low rate and may take over 24 hours to charge.
- To minimize recharging time, turn off the system.

The system can run on AC power and charge the battery in two ways.

- Connected directly to the system
- Connected to a mini-dock/docking system (See the *Mini-Dock User Guide*, *MDS User Guide*, *MDS_e User Guide*, or *MDS Lite User Guide*.)

WARNING: The equipment shall be connected to a center-tapped single phase supply circuit when users in the United States connect the equipment to a 240V supply system.

Caution: Verify that the hospital supply voltage corresponds to the power supply voltage range. See “[Electrical](#)” on page 222.

-
- | | | |
|--------------------------------------|---|--|
| Operate System Using AC power | 1 | Connect the DC power cable from the power supply to the connector on the system. See Figure 2 on page 7. |
| | 2 | Connect the AC power cord to the power supply and connect to a hospital-grade electrical outlet. |

Turning System On/Off

Caution: Do not use the system if an error message appears on the display. Note the error code and turn off the system. Call SonoSite or your local representative.

-
- | | | |
|---------------------------|---|--|
| Turn System On/Off | 1 | Locate the Power key on the top left side of the system. See Figure 3 on page 16. |
| | 2 | Press the Power key once to turn on and once to turn off. |

Wake Up System To conserve battery life, the system is configured to go into sleep mode. The system goes into sleep mode when the lid is closed or if the system has not been touched for a preset amount of time. Press any key, touch the touchpad, or open the lid to wake up the system. To adjust the time for sleep delay, see “[Audio and Battery](#)” on page 31.

Connecting or Removing Transducer

WARNING: To avoid injury to the patient, do not place the connector on the patient. Operate the ultrasound system in a docking system or on a flat hard surface to allow air flow past the connector.

Caution: To avoid damaging the transducer connector, do not allow foreign material in the connector.

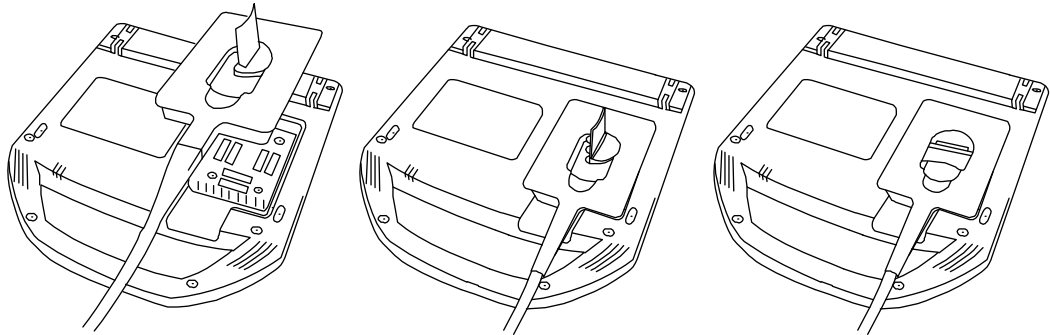

Figure 2 Connect the Transducer

Connect Transducer to System	1	Turn the system upside down (if not in docking system).
	2	Pull the transducer latch up and rotate it clockwise.
	3	Align the transducer connector with the connector on the bottom of the system.
	4	Insert the transducer connector into the system connector.
	5	Turn the latch counterclockwise.
	6	Press the latch down, securing the transducer connector to the system.

Remove Transducer	1	Pull the latch up and rotate it clockwise.
	2	Pull the transducer connector away from the system.

System Controls

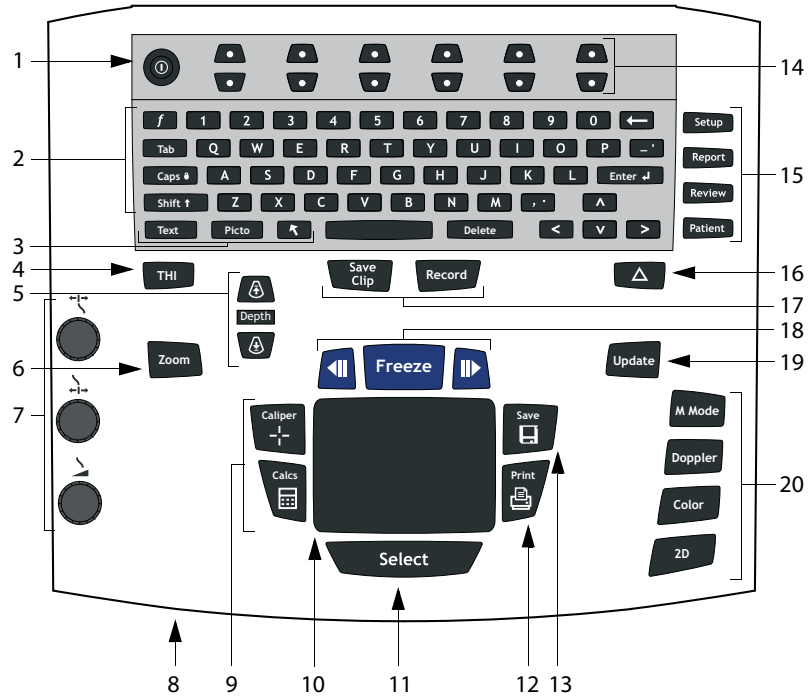

Figure 3 System Controls

Table 1: System Controls

Number	System Control	Description
1	Power	Turns system on and off.
2	Alphanumeric	Use to enter text and numbers.
3	Annotation	
	Text	Turns the keyboard on and off for text entry.
	Picto	Turns the pictographs/pictograph marker on and off.
	Arrow	Displays an arrow that can be moved and rotated within the image area.
4	THI	Turns Tissue Harmonic Imaging on and off.

Table 1: System Controls (Continued)



Number	System Control	Description
5	Depth	
	Depth Up	Decreases imaging depth.
	Depth Down	Increases imaging depth.
6	Zoom	Magnifies image 2x.
7	Gain	
	 Near	Adjusts the gain applied to the near field of the image.
	 Far	Adjusts the gain applied to the far field of the image.
	 Gain	Adjusts the overall gain applied to the entire image.
<i>Note: Some keyboards may have the words instead of symbols.</i>		
8	AC power indicator	A steady green light indicates AC power is connected. A flashing green light indicates the system is in sleep mode.
9	Caliper Calcs	Activates a measurement caliper on the screen. Turns the calculation menu on and off.
10	Touchpad	Use to select, adjust, and move objects on the screen.
11	Select	Use to switch between frozen images in duplex and dual screens, color and Doppler menus, calipers for measurement (Calipers), pictograph marker position/angle (Picto), and arrow position/orientation (Arrow).
12	Print	Prints the active image to the printer.
13	Save	Saves an image to the CompactFlash card and saves measurements/calculation to the report when configured in system setup.
14	Menu controls	Controls features on the on-screen menu which are adjusted based on the system state.

Table 1: System Controls (Continued)

Number	System Control	Description
15	Forms	
	Setup	Access to the system settings.
	Report	Access to the patient report and EMED worksheets.
	Review	Access to the patient list and saved patient images, and archive functions.
	Patient	Access to patient information.
16	△ (Delta key)	Use as a shortcut to existing functionality in the system.
17	Save Clip	Saves a clip to the CompactFlash card.
	Record	Turns DVD/VCR record on and off.
18	Freeze	Stops the live imaging and displays a frozen image.
	Cine (back/forward)	Review images stored in the cine buffer; back/forward through last-in, first-out sequence. All mode images can be stored and reviewed in the cine buffer.
19	Update	Toggles between dual and duplex screens and image modes in M Mode and Doppler, for example, between D-line and Doppler spectral trace.
20	Modes	
	M Mode	Turns M Mode on and toggles between M-line and M Mode trace.
	Doppler	Turns Doppler on and toggles between D-line and Doppler trace.
	Color	Turns CPD/Color on and off.
	2D	Turns 2D on.

Screen Layout

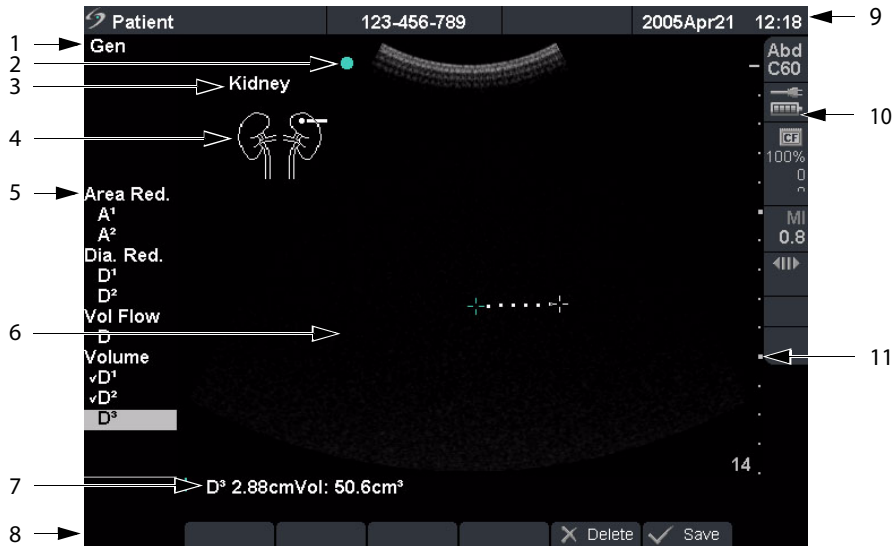

Figure 4 Screen Layout

Table 2: Screen Layout

Number	Item	Description
1	Mode Data	Displays current imaging mode information, for example, Gen, Res, THI, and PW.
2	Orientation Marker	Provides indication for image orientation. In dual and duplex images, the orientation marker is green on the active screen.
3	Text	Displays text entered using keyboard.
4	Picto	Displays pictograph to indicate anatomy and transducer position. Opens pictograph on-screen menu allowing anatomy and screen location selection.
5	Calcs Menu	Displays available calculations.
6	Image	Displays ultrasound image.
7	Measurement and Calcs Data	Displays current measurement and calculation data.
8	On-screen Menu	Access to controls for each system state.

Table 2: Screen Layout (Continued)

Number	Item	Description
9	Patient Header	Displays current patient name, ID number, institution, user, and date/time.
10	System Status	Displays information related to system status, for example, exam type, transducer, AC connected, battery charging, and CompactFlash card.
11	Depth Marker	Displays marks in .5 cm, 1 cm, and 5 cm increments depending on the depth.

General Interaction





Touchpad

The touchpad is used to select, adjust, and move objects on the screen. For example, it controls the caliper position, CPD/Color box position and size, floating cursor, and more. The arrow keys control much of the same functionality as the touchpad.

On-Screen Menus

The on-screen menus, located at the bottom of the screen, provide controls that can be adjusted based on the system state. For example, in 2D, the following options may be available:

Table 3: On-Screen Menus

Icon	Description	Values	Types
 Gen	Controls 2D image optimization	Res, Gen, Pen	Cycle
 Dynamic Range	Adjusts the image by varying the range of displayed grays.	(+3)-(-3)	Up-Down
 Dual	Displays side-by-side images		On-Off
 U/L D/L D/R U/R	Flips the image up/left Flips the image down/left Flips the image down/right Flips the image up/right		Cycle
 Brightness	Controls display brightness	1-10	Up-Down

Menu Controls

The menu controls consist of six sets of 2-button groups at the top of the control panel. They adjust the values of each control displayed in the on-screen menu. The buttons function in one of four ways, depending on context.

Table 4: Menu Control Options

Control	Description
Cycle	Moves through a list of values, then begins again when the bottom or top of the list is reached.
Up-Down	Stops at the top and bottom of a value list, not allowing user to go from the first to last or last to first value in one button press.
On-Off	Turns available features on or off depending on their current state.
Action	Performs some action related to an object on the screen.

Annotation and Text

Keyboard Controls

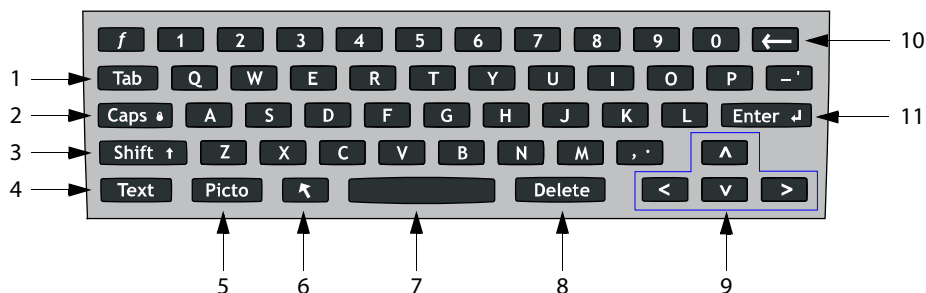

Figure 5 Keyboard Controls

Table 5: Keyboard Controls

Number	Key	Description
1	Tab	Moves cursor among fields in the forms and tabs between text position in dual screens.
2	Caps	Locks keyboard in caps mode.
3	Shift	Allows entry of capitalized characters and international characters.
4	Text	Turns the keyboard on and off for text entry.
5	Picto	Turns pictographs on and off.
6	Arrow	Displays an arrow that can be moved and rotated within the image area.
7	Spacebar	Turns the keyboard on for text entry or adds a space with access to additional on-screen menus (symbols, delete line and done.)
8	Delete	Removes all text from the screen during text entry and when in non-measurement modes.
9	Arrow keys	Moves highlighted selection in calculations menus, moves cursor one space when entering text, moves caliper position, and moves among pages in image review and reports.
10	Backspace	Removes one character to the left of the cursor in text entry mode.
11	Enter	Moves cursor among fields in forms and saves calculations to report.

Symbols

Note: Not all of the symbols/special characters are available in fields and forms.

Symbols/special characters can be entered in selected fields and forms:

- Patient Information: Last, First, Middle, ID, Accession, Indications, Procedure ID, User, Reading Dr., Referring Dr., and Institution.
- Connectivity (DICOM and SiteLink) Configure: Alias, AE Title.
- Delta Key, Annotations: Text.
- Text mode (Imaging): Annotation field.

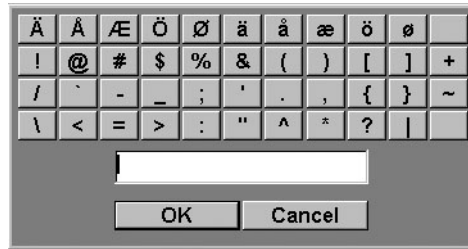

Figure 6 Symbols/Special Characters

-
- | | |
|--|--|
| Enter Symbol/
Special
Character | <ol style="list-style-type: none"> 1 Select the desired field and then select Symbols. 2 Click the desired symbol/character.
In the Symbols dialog box, the keyboard controls may also be used. 3 Click OK. |
|--|--|

Forms

A floating cursor is available in the setup, patient, and report forms. The floating cursor allows interaction through the touchpad and the **Select** key. For example, in the patient form, placing the floating cursor over the last name field and pressing the **Select** key activates that field. Additionally, the floating cursor can be used to interact with the list and check boxes.

System Setup

System setup is used to customize the system. Press the **Setup** key to access and set up the following system functions:

Administration	Configure system to protect patient data by requiring users to log on and enter passwords.
Audio, Battery	Configure for type of Key click, Audio alert, Sleep delay, and Power delay.
Cardiac Calculations	Customize predefined labels to display in Tissue Doppler Imaging (TDI) calculation menu and on report page.
Connectivity	Configure Printer, Video Mode, Serial Port, CF Capacity Alert, and Transfer Mode: DICOM or SiteLink setup (DICOM and SiteLink are optional features).
Date and Time	Configure Date and Time functions.
Delta Key, Annotations	Configure existing system functionality as a shortcut, customize predefined labels, and set preference for managing text when unfreezing images.
Display Information	Configure information displayed on image: Patient Header, Mode Data, and System Status.
IMT calculations	Customize predefined labels to display in the IMT calculation menu and on the report page.
OB Calculations	Select OB calculation table authors and import/export additional OB tables.
OB Custom Measurements	Customize system for user-defined measurements to display in the OB calculations menu and on the report page (OB Custom Measurements are an optional feature).
Presets	Configure Preset functions: Doppler Scale, Duplex, Live Trace, Thermal Index, Save Key, Dynamic Range, Units, and Footswitch settings.
System Information	Displays system hardware and software versions, and license information.
Network Status	Displays system IP address, Location, WLAN Profile, Active WLAN SSID, Ethernet MAC address, and Wireless MAC address.

Set Security Settings

Security Setup

WARNING: Health care providers who maintain or transmit health information are required by the Health Insurance Portability and Accountability Act (HIPAA) of 1996 and the European Union Data Protection Directive (95/46/EC) to implement appropriate procedures: to ensure the integrity and confidentiality of information; to protect against any reasonably anticipated threats or hazards to the security or integrity of the information or unauthorized uses or disclosures of the information.

SonoSite provides a comprehensive set of tools on the system that allows its customers to meet the applicable security requirements listed in the HIPAA standard. SonoSite's customers are ultimately responsible for ensuring the security and protection of all electronic protected health information collected, stored, reviewed, and transmitted on the system.

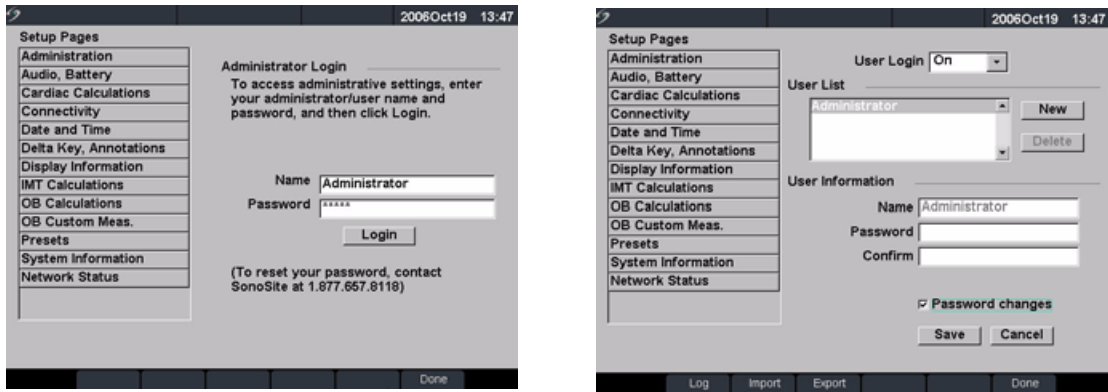

Figure 7 Setup: Administration and Administrator Information

Administrator Login

- 1 Press the **Setup** key.
- 2 Select **Administration**.
- 3 In **Administrator Login**, type **Administrator** in the **Name** field.
- 4 Call SonoSite for the password: 1-877-657-8118 (USA and Canada only).
- 5 Select **Login**.

Change Administrator Password

- 1 In **User Information**, enter your new password in the **Password** field.
- 2 Enter the password again in the **Confirm** field.
To ensure passwords are secure, it is recommended that passwords contain characters from the following categories:
 - Upper case characters: A-Z
 - Lower case characters: a-z
 - Numbers: 0-9The password is case-sensitive.
- 3 In **Password changes**, click on the check box to allow users access to change their password or leave unchecked to restrict access. (Optional)
- 4 Select **Save**.

User Login Setting

- 1 In the **User Login** list, select **On** or **Off**.
 - Selecting **On** restricts access to the system and requires the user to enter a user name and password.
 - Selecting **Off** allows access to the system and does not require the user to enter a user name and password.
- 2 After making changes in the Administration setup, reboot the system to log off as administrator.

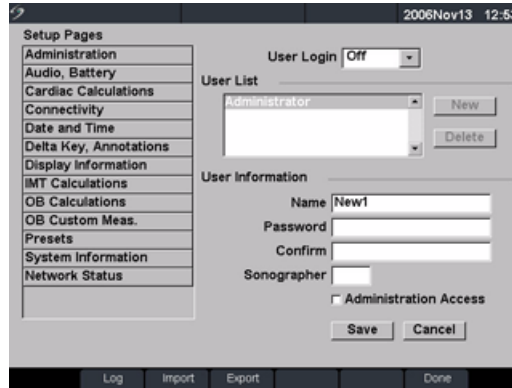

Figure 8 Setup: User List Information

Add New User

- 1 Select **New**.
- 2 In **User Information**, enter information in **Name**, **Password**, and **Confirm** fields.
To ensure passwords are secure, it is recommended that passwords contain characters from the following categories:
 - Upper case characters: A-Z
 - Lower case characters: a-z
 - Numbers: 0-9The name and password are case-sensitive.
- 3 In **Sonographer**, enter the user's initials to display the information in the patient header and the sonographer field in the Patient Information form. (Optional)
- 4 In **Administration Access**, click the check box to allow users access to all administration privileges or leave unchecked to restrict access. (Optional)
- 5 Select **Save**.

Modify User Information

- 1 In the **User List**, select desired user name.
- 2 Enter the new name.
- 3 Enter the new password and confirm.
- 4 Select **Save**.
Any change to the user name replaces the old name.

Delete User

- 1 In the **User List**, select the desired user name.
- 2 Select **Delete**.
A dialog box is displayed.
- 3 Select **Yes** to delete or **No** to cancel.

Change User Password	<ol style="list-style-type: none">1 In the User List, select the desired user name.2 Enter the new password and confirm.3 Select Save.
-----------------------------	--

Done	Select Done from the on-screen menu to return to live imaging.
-------------	---

Export or Import User Accounts

Note: Export and import are used to configure multiple systems and to back up user account information.

Export User Account	<ol style="list-style-type: none">1 Insert the CompactFlash card in the back slot of the system. See “Installing or Removing CompactFlash Card” on page 12.2 Press the Setup key.3 Select Administration.4 Select Export from the on-screen menu. All user names and passwords are copied to the CompactFlash card.5 Remove the CompactFlash card.
----------------------------	---

Import User Account	<ol style="list-style-type: none">1 Insert the CompactFlash card in the back slot of the system. See “Installing or Removing CompactFlash Card” on page 12.2 Press the Setup key.3 Select Administration.4 Select Import from the on-screen menu.<ul style="list-style-type: none">• A dialog box is displayed.• After all user names and passwords are imported, the system restarts.• All user names and passwords currently on the system are replaced with the imported data.
----------------------------	---

Reset	Select Reset from the on-screen menu to return settings for this setup page to factory default.
--------------	--

Export and Clear Event Log

The Event Log collects errors and events and can be exported to a CompactFlash card and read by a CompactFlash reader.



Figure 9 Event Log

View Event Log

- 1 Press the **Setup** key.
 - 2 Select **Administration**.
 - 3 Select **Log** from the on-screen menu.
The Event Log is displayed.
 - 4 Select **Back** to return to the previous menu.
-

Export Event Log

Note: The Event log and the DICOM network log have the same filename (log.txt). When you export either one to the same CompactFlash card, it will overwrite the existing log.txt file.

- 1 Insert the CompactFlash card in the back slot of the system.
 - 2 Select **Log** and then **Export** from the on-screen menu.
 - 3 View the files on a CompactFlash reader.
The log is a text file that can be opened by a text file application, for example, Microsoft Word or Notepad. The log file is named log.txt.
-

Clear Event Log

- 1 Select **Clear** from the on-screen menu.
- 2 Select **Yes** to delete or **No** to cancel.

Login to System as User

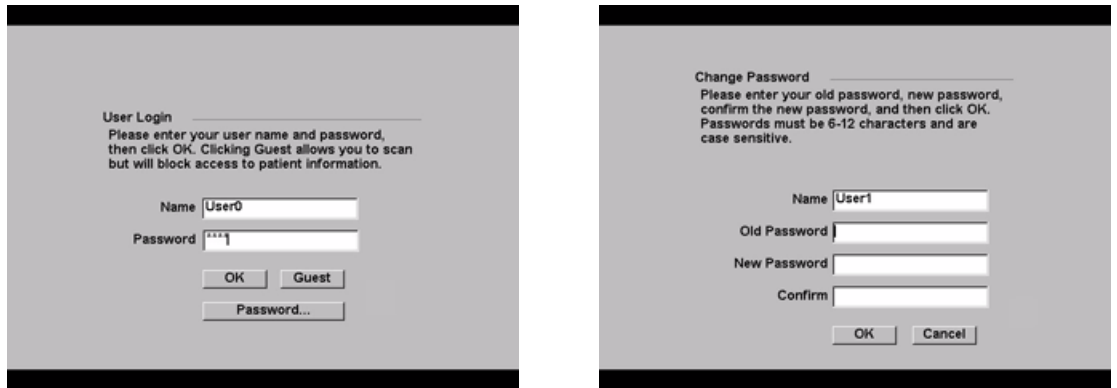

Figure 10 User Login and Change Password

Note: User Login is displayed when system access is turned on.

User Login	In User Login , enter Name and Password and select OK .
Guest Login	In User Login , select Guest . In Guest mode the user is able to scan but is restricted from accessing system setup and patient information.
Change Password	<ol style="list-style-type: none">1 In User Login, select Password.2 Enter your old password, new password, confirm the new password and then select OK. To ensure passwords are secure, it is recommended that passwords contain characters from the following categories:<ul style="list-style-type: none">• Upper case characters: A-Z• Lower case characters: a-z• Numbers: 0-9The password is case-sensitive.

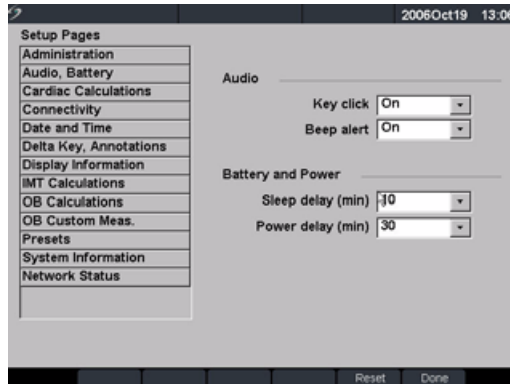

Figure 11 Setup: Audio, Battery

Key Click

- 1 Press the **Setup** key.
- 2 Select **Audio, Battery**.
- 3 In the **Key click** list, select **On** or **Off**.

Beep Alert

- 1 Press the **Setup** key.
- 2 Select **Audio, Battery**.
- 3 In the **Beep alert** list, select **On** or **Off**.

Sleep Delay

- 1 Press the **Setup** key.
- 2 Select **Audio, Battery**.
- 3 In the **Sleep delay** list, select **Off**, **5**, or **10** minutes.

Power Delay

- 1 Press the **Setup** key.
- 2 Select **Audio, Battery**.
- 3 In the **Power delay** list, select **Off**, **15**, or **30** minutes.

Reset

Select **Reset** from the on-screen menu to return settings for this setup page to factory default.

Cardiac Calculations

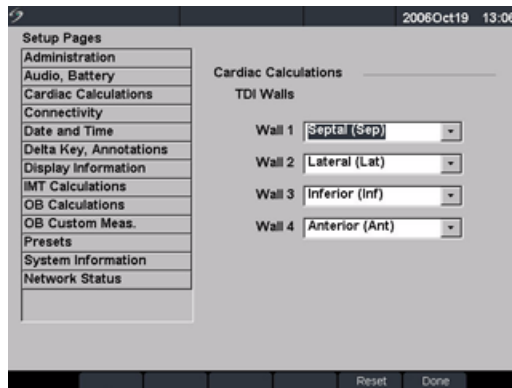

Figure 12 Setup: Cardiac Calculations

-
- Set Cardiac Calculations**
- 1 Press the **Setup** key.
 - 2 Select **Cardiac Calculations**.
 - 3 In the **TDI Walls** lists, select the desired labels for each of the walls. The labels selected are displayed in the TDI calculation menu and on the report.
 - 4 Select **Done** from the on-screen menu.

Reset Select **Reset** from the on-screen menu to return settings for this setup page to factory default.

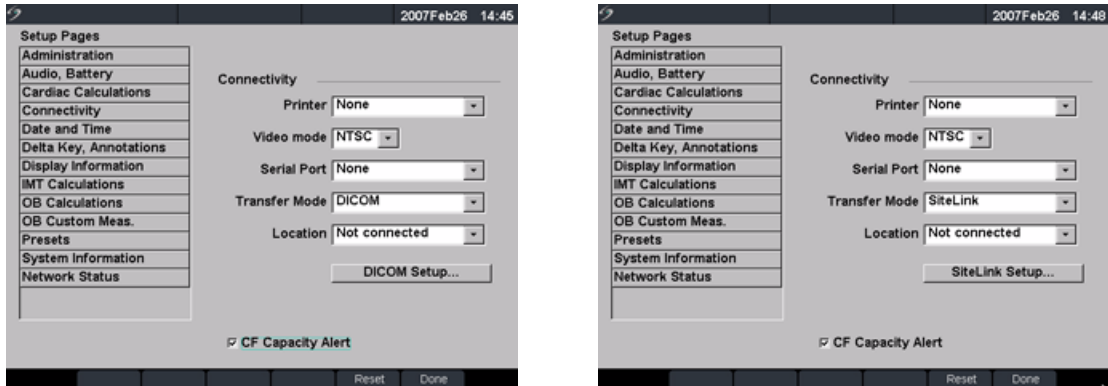

Figure 13 Setup: Connectivity, DICOM and SiteLink

Printer

- 1 Press the **Setup** key.
- 2 Select **Connectivity**.
- 3 In the **Printer** list, select the desired printer from the list of recommended printers.

Video Mode

- 1 Press the **Setup** key.
- 2 Select **Connectivity**.
- 3 In the **Video Mode** list, select **NTSC** or **PAL** for the desired mini-dock video output.

Serial Port

- 1 Press the **Setup** key.
- 2 Select **Connectivity**.
- 3 In the **Serial Port** list, select the desired peripheral: **VCR**, **DVD**, **Computer (PC)**, or **Bar Code Scanner**.
Note: Because these peripherals use the same RS-232 connector on the mini-dock, you can connect only one of these peripherals at a time.
- 4 Restart the system to activate connectivity to the new peripheral.
- 5 Attach a serial cable (RS-232) to the serial port from the mini-dock or docking system to the desired peripheral.
 - If PC is selected, the system allows report data to be sent as ASCII text from the system to a PC.
 - Special third party software must be on the PC to acquire, view, or format the data into a report.
 - Check the compatibility of your software with SonoSite Technical Support.

Transfer Mode	<ol style="list-style-type: none"> 1 Press the Setup key. 2 Select Connectivity. 3 In the Transfer Mode list, select DICOM or SiteLink. 4 Select DICOM Setup or SiteLink Setup as appropriate. <ul style="list-style-type: none"> • If the transfer mode is changed, a dialog box is displayed to restart the system. • For more information on setting up DICOM or SiteLink, see Chapter 5, "Connectivity and Configuration". • The settings for SiteLink Image Manager and system configurations must correspond. See the <i>SiteLink Image Manager User Guide</i>.
Location	<ol style="list-style-type: none"> 1 Press the Setup key. 2 Select Connectivity. 3 In the Locations list, select the desired DICOM or SiteLink location. <ul style="list-style-type: none"> • If the Location is changed, a dialog box is displayed to restart the system. • See Chapter 5, "Connectivity and Configuration" for configuring locations in DICOM or SiteLink.
CF Capacity Alert	<ol style="list-style-type: none"> 1 Press the Setup key. 2 Select Connectivity. 3 Select CF Capacity Alert. When CF Capacity Alert is selected, the system alerts the user if the Compact Flash card is near capacity at End Exam then deletes archived patient exams if desired.
Reset	Select Reset from the on-screen menu to return settings for this setup page to factory default.

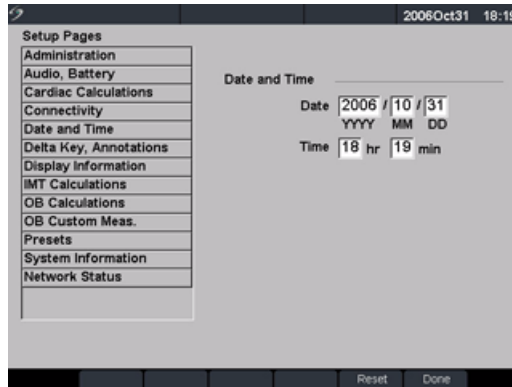

Figure 14 Setup: Date and Time

WARNING: An accurate date and time are critical for accurate obstetrics calculations. Verify that the date and time are accurate before each use of the system. The system does not automatically adjust for daylight savings time changes.

Date

- 1 Press the **Setup** key.
- 2 Select **Date and Time**.
- 3 In the **Date** field, enter the current date (year, month, and day).

Time

- 1 Press the **Setup** key.
- 2 Select **Date and Time**.
- 3 In the **Time** field, enter the current time in 24 hour format (hours and minutes).

Reset Select **Reset** from the on-screen menu to return settings for this setup page to factory default.

Delta Key and Annotation

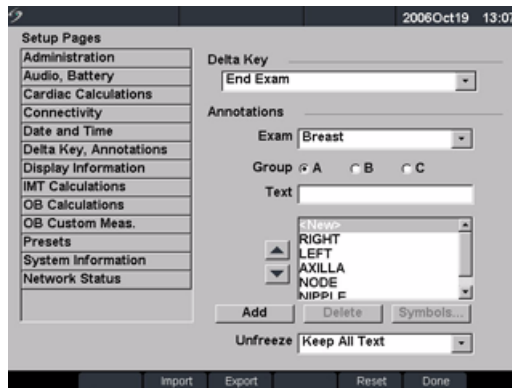

Figure 15 Setup: Delta Key, Annotations

Delta Key

- 1 Press the **Setup** key.
- 2 Select **Delta Key, Annotations**.
- 3 In the **Delta Key** list, select desired functionality for the Delta key. The Delta key now controls this function.

Annotations

- 1 Press the **Setup** key.
- 2 Select **Delta Key, Annotations**.
- 3 In the **Exam** list, select the desired exam type.
- 4 Select the **Group A, B, or C** for the predefined labels you want associated with that exam. The preset labels show for the selected group.
- 5 Add a label to a group by selecting the group then entering the label name in the **Text** field and selecting **Add**.
- 6 Rename an existing label by highlighting it, typing the new name in the **Text** field, and selecting **Rename**.
- 7 Move a label within a group by highlighting it and selecting the up or down arrow.
- 8 Delete a label from a group by highlighting it and selecting **Delete**. Symbols can be used when naming labels. For more information on using symbols, see [“Symbols”](#) on page 23.

Unfreeze	<p>Preset options for saving text when an image is unfrozen or when image layout changes.</p> <ol style="list-style-type: none">1 Press the Setup key.1 Select Delta Key, Annotations.2 In the Unfreeze list, select the desired text state: Keep All Text, Keep Home Text, or Clear All Text.<ul style="list-style-type: none">• Home text runs to the right of the home cursor position. For more information on setting the home cursor position, see "Home/Set" on page 74.• The default is Keep All Text.
Import	<p>Imports and replaces all predefined label groups for all exams with those from the CF card.</p>
Export	<p>Saves and exports all predefined label groups for all exams to the CF card.</p>
Reset	<p>Select Reset from the on-screen menu to return settings for this setup page to factory default.</p>

Display Information

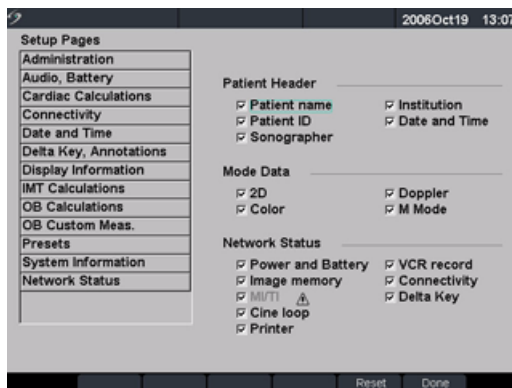

Figure 16 Setup: Display Information

Patient Header	<ol style="list-style-type: none">1 Press the Setup key.2 Select Display Information.3 Select the desired check boxes to display information in the patient header.
Mode Data	<ol style="list-style-type: none">1 Press the Setup key.2 Select Display Information.3 Select the desired check boxes to display imaging information on the screen.
System Status	<ol style="list-style-type: none">1 Press the Setup key.2 Select Display Information.3 Select the desired check boxes to display the system status on the screen.
Reset	Select Reset from the on-screen menu to return settings for this setup page to factory default.

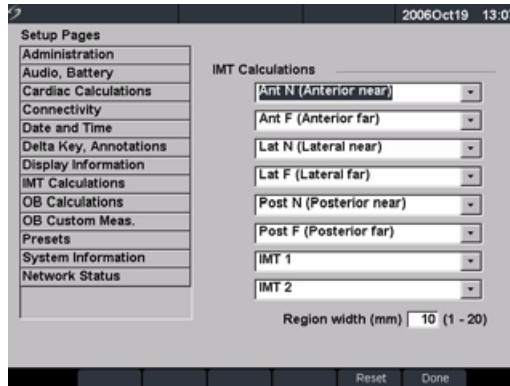

Figure 17 Setup: IMT Calculations

IMT Calculations

- 1 Press the **Setup** key.
- 2 Select **IMT Calculations**.
- 3 In the **IMT Calculations** list, select the desired labels.
 - Selecting a label places the measurement on the Calculation menu and into the report.
 - Selecting None removes a label.
- 4 Enter the desired Region width.

Reset

Select **Reset** from the on-screen menu to return settings for this setup page to factory default.

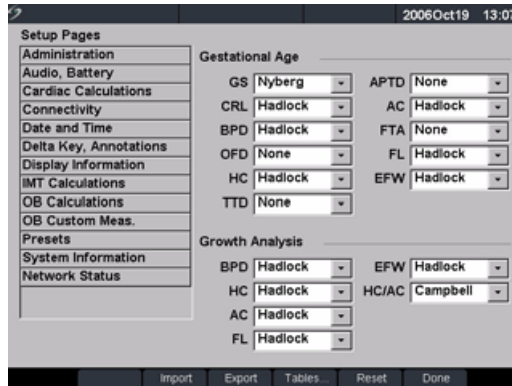

Figure 18 Setup: OB Calculations

Gestational Age Growth Analysis

- 1 Press the **Setup** key.
- 2 Select **OB Calculations**.
- 3 In **Gestational Age** or **Growth Analysis** lists, select the desired OB authors.
 - Selecting an author places the measurement on the calculation menu.
 - Selecting None removes the measurement from the calculation menu.

More

Select **More** to display the list of user-defined custom measurements and to associate a custom table for the custom measurement. This option is only available when a user-defined custom table has been created for the custom measurement.

Export

- 1 Insert a blank CompactFlash card in the back slot of the system.
- 2 Press the **Setup** key.
- 3 Select **OB Calculations**.
- 4 Select **Export** from the on-screen menu.
All user-defined tables and measurements are copied to the CompactFlash card.

Import	<ol style="list-style-type: none">1 Insert the CompactFlash card in the back slot of the system.2 Press the Setup key.3 Select OB Calculations.4 Select Import from the on-screen menu.5 Select Yes to import data or No to cancel.<ul style="list-style-type: none">• After all user-defined tables and measurements are imported, the system restarts.• All user-defined tables and measurements currently on the system are replaced with imported data.6 Select Done from the on-screen menu to return to live imaging.
Tables	Select Tables from the on-screen menu to display system OB tables or to create custom OB tables. See “OB Custom Tables” on page 43.
Reset	Select Reset from the on-screen menu to return settings for this setup page to factory default.

OB Custom Measurements

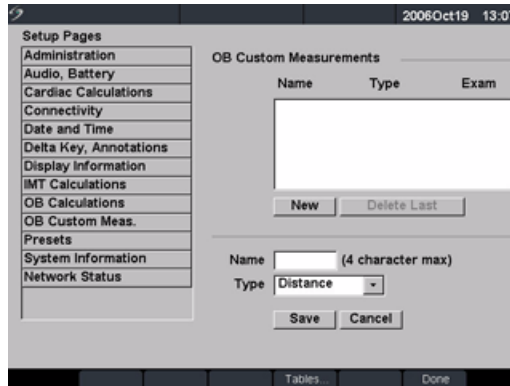

Figure 19 Setup: OB Custom Measurements

OB Custom Measurements

- 1 Press the **Setup** key.
- 2 Select **OB Custom Meas.**
- 3 Select **New**.
- 4 In the **Name** field, enter a unique name.
- 5 In the **Type** list, select the desired measurement type.
- 6 Select **Save**.
 - The new measurement is displayed in the calculations menu and the OB report.
 - Up to five custom measurements may be saved.

Delete OB Custom Measurement

- 1 Press the **Setup** key.
- 2 Select **OB Custom Meas.**
- 3 In the **Custom Measurements** list, highlight the last measurement.
- 4 Select **Delete Last**.
- 5 Select **Yes** to delete the measurement or **No** to cancel.
If associated tables and report data exist for the measurement, they are removed from the system.

Tables

Select **Tables** from the on-screen menu to display system OB tables or to create Gestational Age tables for a custom OB measurement. See "[OB Custom Tables](#)" on page 43.

OB Custom Tables

D(cm)	Age	Range
1	0.20	5w5d 0w4d
2	0.30	5w6d 0w4d
3	0.40	6w1d 0w4d
4	0.50	6w1d 0w4d
5	0.60	6w3d 0w4d
6	0.70	6w4d 0w4d
7	0.80	6w5d 0w4d
8	0.90	6w6d 0w4d
9	1.00	7w1d 0w4d
10	1.10	7w1d 0w4d

Wks	-2SD	Mean	+2SD
1	12.00	1.42	1.83 2.24
2	12.50	1.60	2.01 2.43
3	13.00	1.78	2.20 2.62
4	13.50	1.95	2.38 2.81
5	14.00	2.13	2.57 3.00
6	14.50	2.30	2.75 3.19
7	15.00	2.48	2.93 3.38
8	15.50	2.65	3.11 3.56
9	16.00	2.82	3.28 3.75
10	16.50	2.99	3.46 3.93

Figure 20 Setup: OB Custom Table

Gestational Age Table Measurements: The system provides gestational age measurements by selected authors for the age table measurements listed in [Table 6](#).

Growth Analysis Table Measurements: The system provides growth graphs or curves for the growth table measurements listed in [Table 6](#).

Table 6: OB Custom Table Measurements

Gestational Age Table Measurements	GS, CRL, BPD, OFD, HC, TTD, AC, FTA, FL, 5 additional custom measurement labels
Growth Analysis Table Measurements	BPD, HC, AC, FL, EFW

WARNING: Prior to use, verify custom table data entries are correct. The system does not confirm the accuracy of the custom table data entered by the user.

View OB Tables

- 1 Press the **Setup** key.
- 2 Select **OB Custom Meas.** or **OB Calculations**.
- 3 Select **Tables** from the on-screen menu.
- 4 Select the desired table (Age or Growth) and measurement/author.

Create New OB Custom Tables

- 1 Press the **Setup** key.
- 2 Select **OB Custom Meas.** or **OB Calculations.**
- 3 Select **Tables** from the on-screen menu.
- 4 Select the desired table (**Age** or **Growth**).
- 5 In the measurement list, select the desired measurement for the custom table.
- 6 Select **New** from the on-screen menu.
- 7 In the **Author** field, enter a unique name.
- 8 Enter the data.
- 9 Select **Save** from the on-screen menu.

Two custom tables may be created for each OB measurement.

- To display the measurement for the custom table in the calculation menu, see [“OB Calculations Authors”](#) on page 40 and select More.
- Growth analysis tables cannot be created for custom OB measurements.

Edit OB Custom Tables

- 1 Press the **Setup** key.
- 2 Select **OB Custom Meas.** or **OB Calculations.**
- 3 Select **Tables** from the on-screen menu.
- 4 Select the desired custom OB table.
- 5 Select **Edit** and enter data and then select **Save** from the on-screen menu.

Delete OB Custom Tables

- 1 Press the **Setup** key.
- 2 Select **OB Custom Meas.** or **OB Calculations.**
- 3 Select **Tables** from the on-screen menu.
- 4 Select the desired custom OB table.
- 5 Select **Delete** from the on-screen menu to remove the custom table from the system.

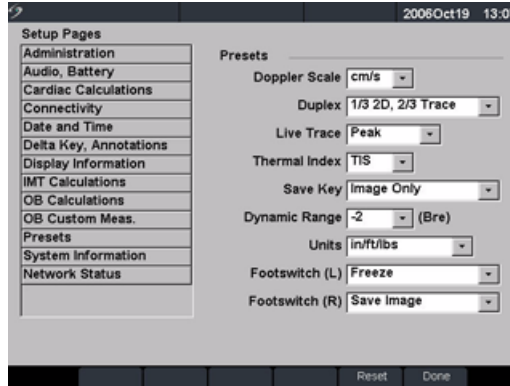

Figure 21 Setup: Presets

Doppler Scale

- 1 Press the **Setup** key.
- 2 Select **Presets**.
- 3 In the **Doppler Scale** list, select **cm/s** or **kHz**.

Duplex

- 1 Press the **Setup** key.
- 2 Select **Presets**.
- 3 In the **Duplex** list, select the desired image display.
 - Full 2D, Full Trace
 - 1/3 2D, 2/3 Trace
 - 1/2 2D, 1/2 Trace

Live Trace

- 1 Press the **Setup** key.
- 2 Select **Presets**.
- 3 In the **Live Trace** list, select **Peak** or **Mean**.

Thermal Index

- 1 Press the **Setup** key.
- 2 Select **Presets**.
- 3 In the **Thermal Index** list, select **TIS**, **TIB**, or **TIC**.
The Thermal Index default setting is based on exam type.
 - OB: TIB
 - TCD: TIC
 - All others: TIS

Save Key	<ol style="list-style-type: none"> 1 Press the Setup key. 2 Select Presets. 3 In the Save Key list, select Image Only or Image/Calcs to designate the function of the Save Key. <ul style="list-style-type: none"> • Selecting Image Only allows the Save Key to save the image to the CompactFlash card. • Selecting Image/Calcs allows the Save Key to save the image to the CompactFlash card and to save the current calculation to the report.
Dynamic Range	<ol style="list-style-type: none"> 1 Select the desired exam type. See “Exam” on page 51. 2 Press the Setup key. 3 Select Presets. 4 In the Dynamic Range list, select the setting: -3, -2, -1, 0, +1, +2, +3. Negative numbers show higher contrast images and positive numbers show lower contrast images.
Units	<ol style="list-style-type: none"> 1 Press the Setup key. 2 Select Presets. 3 In the Units list, select the desired units for patient height and weight: in/ft/lbs or cm/m/kg. Units settings available in cardiac exams only.
Footswitch (Left/Right)	<ol style="list-style-type: none"> 1 Press the Setup key. 2 Select Presets. 3 In the Footswitch (L) and Footswitch (R) list, select desired functionality for the left and right footswitch: Save Clip, Record, Freeze, Save Image, Print.
Reset	Select Reset from the on-screen menu to return settings for this setup page to factory default.

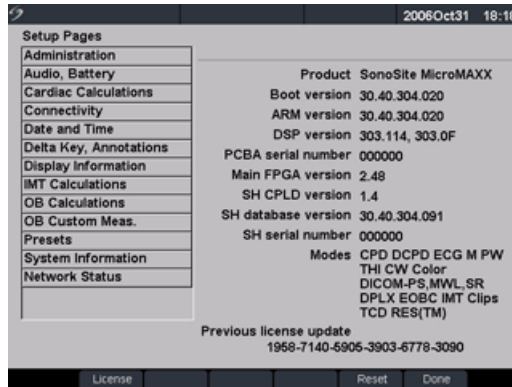

Figure 22 Setup: System Information

System Information

- 1 Press the **Setup** key.
- 2 Select **System Information**.
To install a license key see [“Installing a License Key”](#) on page 185.

Change to Default Settings

- 1 Turn the system off.
- 2 Connect the system to AC power. See [“Operate System Using AC power”](#) on page 14.
- 3 Simultaneously press and release **1** and the **Power** key.
 - The system beeps several times, and the system displays the default settings.
 - Default settings are set at the factory and cannot be changed by the user.

Network Status

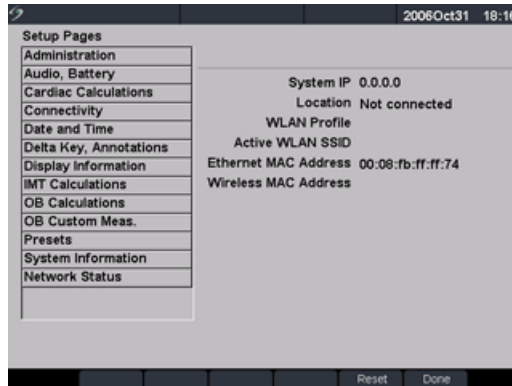

Figure 23 Setup: Network Status

Network Status

- 1 Press the **Setup** key.
- 2 Select **Network Status**.

Chapter 3: Imaging

Patient Information

The patient information form allows information to be entered into the system for the patient exam.

- Information which can be entered includes patient demographics, exam information, and clinical information.
- This information is automatically placed on the last page of the patient report.
- Once a patient is entered, all saved images are linked to that patient.
- To end the exam, a New Patient can be created or End Exam can be selected.
- Patient information can be edited during the exam by pressing the **Patient** key. However, if the patient name, ID, or Accession changes, a new patient is created.

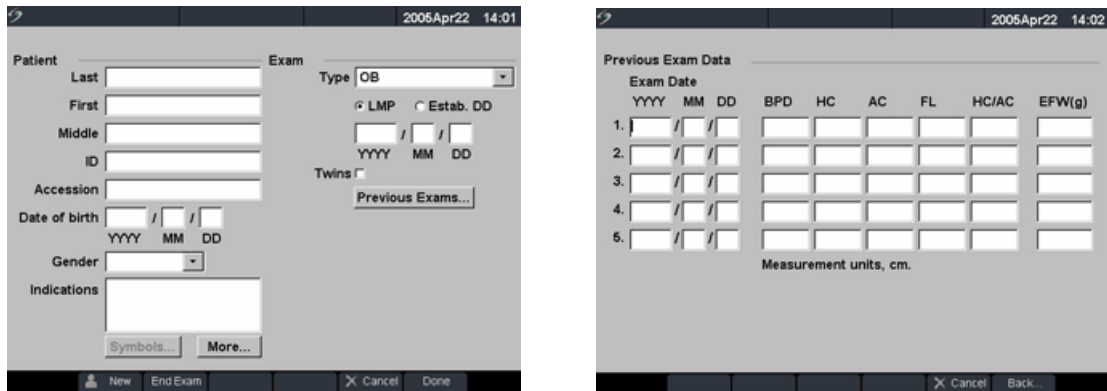

Figure 1 Patient Information Form

New Patient



- 1 Press the **Patient** key.
- 2 Select **New** from the on-screen menu.
 - This clears the existing patient information.
 - Selecting new patient erases any previously entered information, including any calculations and report pages. To save this information, save the screen for each item, for example, report pages, patient information, calculations, and graphs.

New Patient (continued)

- 3 Enter information into appropriate fields.
The patient information fields vary based on the selected exam type.

- **Patient**

- **Patient:** Enter Last, First, Middle Names, and ID.
- **Accession:** Enter number, if applicable.
- **Date of birth:** Enter (YYYY/MM/DD).
- **Gender:** Select Female, Male, other, or leave blank.
- **Indications:** Enter desired text.
- **Symbols:** See “[Symbols](#)” on page 23.

- **More**

- **User:** Enter initials.
- **Reading Dr.** and **Referring Dr.:** Enter names.
- **Institution:** Enter name.

All patient information can be edited up until the first image is saved. After the first image is saved, the Patient Name, ID, and Accession number cannot be modified. Modifying these fields closes the current patient exam and starts a new exam.

Select **Back** from the on-screen menu to save information and return to previous menu.

New Patient (continued)

• Exam

- **Type:** Select desired exam type.
- **LMP** or **Estab. DD:** Select **LMP** or **Estab. DD** then enter either last menstrual period or established due date (YYYY/MM/DD). (Estab.DD only in OB exam.) The date for LMP must precede the current system date.
- **Twins:** Select the Twins check box to display Twin A and Twin B measurements on the calculation menu (only in OB exam and report).
- **Previous Exams** (only in OB exam).
 - Enter data from previous exams. Data from five previous exams may be entered.
 - For twins, select **Twin A/B** from the on-screen menu to enter data for each twin.

The date for a previous exam must precede the current system date.

Select **Back** from the on-screen menu to save information and return to previous menu.

- **BP:** Enter blood pressure (only in cardiac, vascular, and IMT exams).
- **HR:** Enter the Heart Rate (only in cardiac, vascular, and IMT exams). If the heart rate is obtained and saved using M Mode, the values override the number entered on the patient information screen.
- **Height:** Enter the patient height in feet and inches or meters and centimeters (only in cardiac exam).
- **Weight:** Enter the patient weight in pounds or kilos (only in cardiac exam).
- **BSA** (Body Surface Area): This number is automatically generated after height and weight are entered (only in cardiac exam).
- **Ethnicity:** Select the applicable ethnic origin (only in IMT exam).

End Exam

- 1 Press the **Patient** key.
- 2 Select **End Exam** from the on-screen menu to close the current patient exam.
Selecting End Exam, selecting New Patient, or modifying patient name or ID erases any previously entered information, including any calculations and report page. To save this information, save the screen for each item, for example, report pages, patient information, and calculations.

Cancel



Select **Cancel** from the on-screen menu to undo any changes to the patient information form and return to the previous imaging state.
Pressing Cancel does not close the current patient exam.

-
- Done** Select **Done** from the on-screen menu to save information and return to the previous imaging state.
- Information is saved when exiting the patient information form unless Cancel is selected from the on-screen menu.
 - If any changes are made to the current patient's name, ID, or accession number, that patient exam is closed and a new one is started.

Transducer, Exam Type, and Imaging Mode

The system has various configurations and options. All are described in this user guide and may not apply to your system. System features depend on your configuration, transducer, and exam type.

WARNING: The diagnostic capability differs for each transducer, exam type, and imaging mode. Verify your system's capabilities prior to diagnosis.

Transducers have been developed to specific criteria depending on their application. This criteria includes biocompatibility requirements.

To avoid injury to the patient, use only an orbital exam type (Orb) when performing imaging through the eye. The FDA has established lower acoustic energy limits for ophthalmic use. The system will not exceed these limits only if the Orb exam type is selected.

The following table describes the abbreviations for exam types.

Table 1: Exam Type Abbreviations

Abbreviation	Exam Type
Abd	Abdomen
Bre	Breast
Crd	Cardiac
Gyn	Gynecology
Hep	Hepatic
IMT	Intima Media Thickness
Msk	Muscle
Neo	Neonatal
Nrv	Nerve
OB	Obstetrical
Orb	Orbital

Table 1: Exam Type Abbreviations (Continued)

Abbreviation	Exam Type
Pel	Pelvic
SmP	Small Parts
Sup	Superficial
TCD	Transcranial Doppler
Vas	Vascular

The following table describes the transducer's exam type and imaging mode that may be available with your system.

- The optimization settings for 2D are Res, Gen, and Pen.
- The optimization settings for color power Doppler (CPD) and color Doppler (Color) are low, medium, and high (flow sensitivity) with a range of PRF settings for Color depending on the application.

Table 2: Transducer, Exam Type, and Imaging Mode

Transducer	Exam Type	Imaging Mode								
		2D/ MM	THI	2D MB	2D S	CPD	Color	PW	TDI PW	CW
C11e	Abd	X	—	—	X	X	X	X	—	—
	Nrv	X	—	—	X	X	X	X	—	—
C60e	OB	X	X	—	X	X	X	X	—	—
	Gyn	X	X	—	X	X	X	X	—	—
	Abd	X	X	—	X	X	X	X	—	—
D2	Crđ	—	—	—	—	—	—	—	—	X
HFL38	Bre	X	—	X	X	X	X	X	—	—
	SmP	X	—	X	X	X	X	X	—	—
	Vas	X	—	X	X	X	X	X	—	—
	IMT	X	—	X	X	X	X	X	—	—
	Nrv	X	—	X	X	X	X	X	—	—

Table 2: Transducer, Exam Type, and Imaging Mode (Continued)

Transducer	Exam Type	Imaging Mode								
		2D/ MM	THI	2D MB	2D S	CPD	Color	PW	TDI PW	CW
ICTe	Gyn	X	—	—	—	X	X	X	—	—
	OB	X	—	—	—	X	X	X	—	—
L25e	Msk	X	—	X	X	X	X	X	—	—
	Vas	X	—	X	X	X	X	X	—	—
	Nrv	X	—	X	X	X	X	X	—	—
	Sup	X	—	X	X	X	X	X	—	—
L38e	Bre	X	—	—	X	X	X	X	—	—
	SmP	X	—	—	X	X	X	X	—	—
	Vas	X	—	—	X	X	X	X	—	—
	IMT	X	—	—	X	X	X	X	—	—
	Nrv	X	—	—	X	X	X	X	—	—
LAP	Abd	X	—	—	—	X	X	X	—	—
	Pel	X	—	—	—	X	X	X	—	—
P10	Crd	X	—	—	X	—	X	X	X	X
	Neo	X	—	—	X	X	X	X	—	—
	Abd	X	—	—	X	X	X	X	—	—
	Vas	X	—	—	X	X	X	X	—	—
	Nrv	X	—	—	X	X	X	X	—	—
P17	Abd	X	X	—	X	X	X	X	—	—
	OB	X	X	—	X	X	X	X	—	—
	Crd	X	X	—	X	—	X	X	X	X
	TCD	X	—	—	X	X	X	X	—	—
	Orb	X	—	—	X	X	X	X	—	—

Table 2: Transducer, Exam Type, and Imaging Mode (Continued)

Transducer	Exam Type	Imaging Mode								
		2D/ MM	THI	2D MB	2D S	CPD	Color	PW	TDI PW	CW
SLA	Msk	X	—	—	X	X	X	X	—	—
	Sup	X	—	—	X	X	X	X	—	—
	Vas	X	—	—	X	X	X	X	—	—
	Nrv	X	—	—	X	X	X	X	—	—
SLT	Abd	X	—	—	—	X	X	X	—	—
	Hep	X	—	—	—	X	X	X	—	—
TEE	Crd	X	—	—	—	—	X	X	X	X

Transducer Preparation

WARNING: Some transducer sheaths contain natural rubber latex and talc, which can cause allergic reactions in some individuals. Refer to 21 CFR 801.437, User labeling for devices that contain natural rubber.

Some gels and sterilants can cause an allergic reaction on some individuals.

Caution: To avoid damage to the transducer, use only gels recommended by SonoSite. Using gels other than the one recommended by SonoSite can damage the transducer and void the warranty. If you have questions about gel compatibility, contact SonoSite or your local representative.

SonoSite recommends you clean transducers after each use. See [“Cleaning and Disinfecting Transducers”](#) on page 188.

Acoustic coupling gel must be used during exams. Although most gels provide suitable acoustic coupling, some gels are incompatible with some transducer materials. SonoSite recommends Aquasonic® gel and a sample is provided with the system.

General Use

Apply Gel

Apply a liberal amount of gel between the transducer and the body.

Invasive or Surgical Use

WARNING: To prevent contamination, the use of sterile transducer sheaths and sterile coupling gel is recommended for clinical applications of an invasive or surgical nature. Do not apply the transducer sheath and gel until you are ready to perform the procedure.

Install Transducer Sheath

Note: SonoSite recommends the use of market-cleared, transducer sheaths for intracavitary or surgical applications.

- 1 Place gel inside the sheath.
- 2 Insert the transducer into the sheath.
To lessen the risk of contamination, install the sheath only when you are ready to perform the procedure.
- 3 Pull the sheath over the transducer and cable until the sheath is fully extended.
- 4 Secure the sheath using the bands supplied with the sheath.
- 5 Check for and eliminate bubbles between the face of the transducer and the sheath.
If any bubbles are present between the face of the transducer and the sheath, the ultrasound image may be affected.
- 6 Inspect the sheath to ensure there are no holes or tears.

Modes

2D Imaging

The system has advanced image optimization technology that greatly simplifies user controls. To achieve the best possible image quality, it is important to properly adjust the display brightness, gain, depth settings, and exam type.

It is also important to select an optimization setting that best matches your needs.

The system has a high-performance, liquid crystal display (LCD). To optimize image quality, adjust the display for viewing angle, and brightness.

Each time you turn the system on, the 2D image is displayed. It displays echoes in two dimensions on the display by assigning a brightness level based on the echo signal amplitude. This is the system's default imaging mode. When imaging in another mode, you may return to 2D imaging by pressing the **2D** key. If the system does not return to 2D imaging after pressing the **2D** key, ensure the system is in live imaging.



Figure 2 2D Image

Optimize



Select the desired optimization setting from the on-screen menu.

- Res provides the best possible resolution.
- Gen provides a balance between resolution and penetration.
- Pen provides the best possible penetration.





Some of the parameters that are optimized to provide the best image include: focal zones, aperture size, frequency (center and bandwidth), and waveform. They cannot be adjusted by the user.

Dynamic Range



Select the desired dynamic range setting from the on-screen menu to adjust grayscale range: **-3, -2, -1, 0, +1, +2, +3**.

- The positive range increases and the negative range decreases the number of grays displayed.
- A beep sounds when the minimum or maximum of the range is reached.

Dual Images		<ol style="list-style-type: none"> 1 Select Dual from the on-screen menu to display side-by-side 2D images. 2 Press the Update key to display the second screen and to toggle between the screens. With both images frozen, press the Update key to toggle between the images. 3 Select Dual from the on-screen menu or press the 2D key to return to full screen 2D imaging.
LVO (Left Ventricular Opacification)		<p>This feature depends on transducer and exam type.</p> <p>Use LVO for cardiac exams in 2D mode when using an imaging contrast agent. LVO lowers the mechanical index (MI) of the system to enhance visualization of the contrast agent and endocardial border.</p> <ol style="list-style-type: none"> 1 On a 2D image, select LVO On on page 2 of the on-screen menu to turn on LVO. 2 Select LVO Off to turn off this option.
Orientation		<p>Select from four image orientations: Up/Right, Up/Left, Down/Left, Down/Right.</p>
Brightness		<p>Select the desired brightness setting from the on-screen menu to adjust display brightness: 1-10.</p> <ul style="list-style-type: none"> • A beep sounds when the minimum or maximum of the range is reached. • The display brightness affects battery life. To conserve battery life, adjust brightness to a lower setting.
Biopsy		<p>This feature depends on transducer type. Biopsy is not available when ECG cable is connected.</p> <p>Select Biopsy from the on-screen menu to display biopsy guidelines. Select again to turn off.</p> <p>On the P10 and P17 transducers, the biopsy guides are displayed when the bracket is installed correctly. If the bracket is not installed correctly, the biopsy feature is not available, and a dialog box is displayed to check installation of the bracket. See “Needle Guidance” on page 78 and <i>Biopsy User Guide</i> for more information.</p>
Guide		<p>This feature depends on transducer and exam type.</p> <p>Select Guide from the on-screen menu to turn on the guideline and select again to turn off.</p>
SonoRES (S)		<p>This feature is optional and depends on transducer and exam type. When both 2D image enhancements are available, SonoRES® image enhancement capability and SonoMB™ multi-beam technology share the same on-screen menu. See “Transducer, Exam Type, and Imaging Mode” on page 53.</p> <p>Select S from the on-screen menu to turn on SonoRES.</p> <ul style="list-style-type: none"> • When SonoRES is on, an S is displayed in the upper left corner of the screen. • SonoRES is available only in 2D imaging and M Mode.

SonoMB (MB)		<p>This feature depends on transducer and exam type. When both 2D image enhancements are available, SonoRES and SonoMB share the same on-screen menu. See “Transducer, Exam Type, and Imaging Mode” on page 53.</p> <p>SonoMB is on when available.</p> <ul style="list-style-type: none"> • When SonoMB is on, MB is displayed in the upper left corner of the screen. • SonoMB is available only in 2D imaging. • If SonoMB is available on the transducer, ECG monitoring is not available.
ECG		<p>This feature is optional and requires a SonoSite ECG cable.</p> <ol style="list-style-type: none"> 1 Connect the ECG cable. See Figure 2, “System Back View” on page 7. 2 Select ECG from the on-screen menu to display the ECG trace. See “ECG Monitoring” on page 76. <p>If SonoMB is available on the transducer, ECG monitoring is not available.</p>
Clips		<p>This feature is optional.</p> <p>Select Clips from the on-screen menu to display the clips menu. See “Clips” on page 68.</p>
Gain		<p>Turn the Near, Far, or Gain knobs (on the lower left side of the control panel) to increase or decrease the amount of gain applied to the near field, far field, or the overall image. Near and far correspond to the time gain compensation (TGC) controls found on other ultrasound systems.</p>
Auto Gain		<p>This feature depends on transducer type.</p> <p>Select Auto Gain from the on-screen menu. Auto Gain automatically adjusts gain each time it is selected.</p>
Depth		<p>The vertical depth scale is marked in .5 cm, 1 cm, and 5 cm increments, depending on the depth.</p> <p>Press the Depth key up to decrease or down to increase the displayed depth.</p> <ul style="list-style-type: none"> • As you adjust the depth, the maximum depth number changes in the lower right corner of the screen. • A beep sounds when the minimum or maximum of the range is reached.
Tissue Harmonic Imaging		<p>This feature is optional and depends on transducer and exam type.</p> <ol style="list-style-type: none"> 1 Press the THI key to turn on THI. THI is displayed in the top left portion of the screen next to the optimization setting. 2 Press the THI key again to turn off THI. The THI icon is removed from the screen.

Zoom	<ol style="list-style-type: none"> 1 Press the Zoom key. A region of interest (ROI) box is displayed on the screen. 2 Use the Touchpad to position and size the ROI box within the image area. 3 Press the Zoom key again. The image is magnified by a factor of two inside the ROI box. 4 Press the Zoom key again to exit zoom. To exit any zoomed state and return to 2D live in 1x, press the 2D key.
-------------	--

Zoom Pan	<p><i>Note: Panning is available on a frozen, zoomed image. You cannot pan on a frozen image in Dual.</i></p> <ol style="list-style-type: none"> 1 On a frozen 2D image, press the Zoom key. A zoom box is displayed on the screen. 2 Use the Touchpad to position the zoom box within the image area. 3 Press the Zoom key again. The image is magnified by a factor of two at the position of the zoom box. 4 Use the Touchpad to pan the image up/down and left/right. 5 Press the Zoom key again to exit zoom.
-----------------	--

Freeze	<ol style="list-style-type: none"> 1 Press the Freeze key. The cine icon and frame number are displayed in the system status area of the screen. 2 Press the Freeze key again to return to live imaging. The cine icon is removed from the system status area of the screen and live imaging resumes.
---------------	---

Cine Buffer	<div style="display: flex; align-items: center; gap: 10px;">  </div> <p>On a frozen image, press the Cine keys to view individual frames in the cine buffer.</p> <ul style="list-style-type: none"> • The frame number changes dynamically as the cine key is pressed. • The total number of frames in the buffer is displayed in the system status under the freeze icon.
--------------------	--

M Mode Imaging

The following instructions cover Motion mode (M Mode) imaging. See “2D Imaging” on page 57 for instructions about depth and optimization.

M Mode M-Line

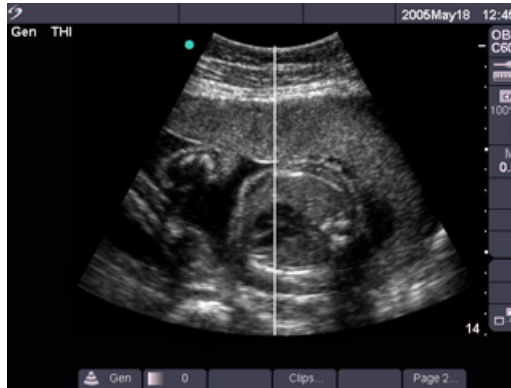

Figure 3 M Mode M-Line

M-Line

- 1 Press the **M Mode** key for the M-line.
If M Mode does not come on, make sure the system is in live imaging.
- 2 Use the **Touchpad** to position the M-line over the area of interest on the image.
 - Depth changes are not available in M Mode trace.
 - Adjust the depth prior to activating the M Mode trace.

M Mode Trace

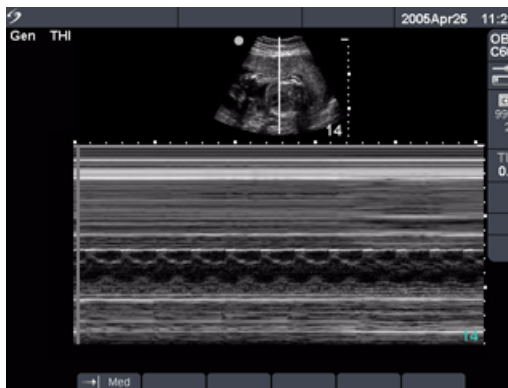

Figure 4 M Mode Trace Image

M Mode Trace

- 1 Press the **M Mode** key again to acquire the M Mode trace. The time scale at the top of the trace has small marks at 200 ms intervals and large marks at one second intervals.
- 2 Press the **Update** key to toggle between the M-line and trace.
- 3 In duplex, press the **M Mode** key to return to the full screen M-line. You can choose from one of three layouts. For duplex imaging, see [“Duplex”](#) on page 45.

Sweep Speed



Select the desired sweep speed from the on-screen menu (slow, med, fast).

Gain

Turn the **Near**, **Far**, or **Gain** knobs (on the lower left side of the control panel) to increase or decrease the amount of gain applied to the near field, far field, or the overall image. Near and far correspond to the time gain compensation (TGC) controls found on other ultrasound systems.

Freeze

- 1 Press the **Freeze** key.
- 2 Press the **Freeze** key again to return to live imaging.
 - The cine icon is removed from the system status area of the screen and live imaging resumes.
 - On the frozen M Mode image, press the **M Mode** key to display the associated frozen 2D image with the M-line, or press the **Update** key to display the 2D live image with the M-line.

Cine Buffer



On a frozen image, press the **Cine** keys to view the trace at different points in time.

2D Imaging

Press the **2D** key to return to 2D imaging.

Color Doppler Imaging

Note: Color power Doppler (CPD) and color Doppler (Color) are optional features and depend on transducer and exam type.

The following instructions cover CPD and Color imaging.

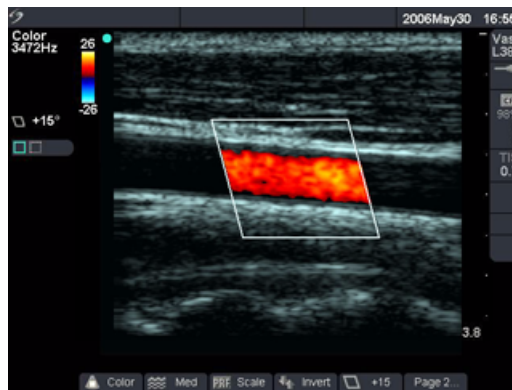

Figure 5 Color Image

CPD or Color



- 1 Press the **Color** key for CPD or Color.
A ROI box is displayed in the center of the 2D image.
- 2 Select **CPD** or **Color** from the on-screen menu.
 - The current setting is displayed in the upper left corner of the screen and in the on-screen menu.
 - In Color or CPD mode, the Color indicator bar is displayed in the upper left corner of the screen. The Color bar displays velocity in cm/s in Color mode only.







ROI Box

- 1 Use the **Touchpad** to position or change the size of the ROI box.
While moving or changing the size of the ROI box, a green outline of the new position or the new size is displayed as it moves on the display.
- 2 Press the **Select** key to toggle between the position and size of the ROI box.
The ROI box indicator on the left side of the screen is highlighted green to show which function the touchpad is controlling.

Color Suppress



- 1 Select **Color Suppress** from the on-screen menu to hide or show color information when in Color or CPD mode.
- 2 Select **Hide** or **Show** while in live or frozen imaging.
 - The setting shown on the on-screen menu is the current state.
 - Color Suppress returns to default state when returning to live imaging from a frozen state.

Flow Sensitivity		<p>Select the desired flow sensitivity from the on-screen menu.</p> <ul style="list-style-type: none"> • Low optimizes the system for low flow states. • Med optimizes the system for medium flow states. • High optimizes the system for high flow states. <p>The current setting is displayed in the top left portion of the screen and in the on-screen menu.</p>
PRF Scale		<p><i>Note: This menu option is available in Color and in CPD on select transducers.</i></p> <p>Select the desired pulse repetition frequency (PRF) setting from the on-screen menu.</p> <ul style="list-style-type: none"> • A beep sounds when the minimum or maximum of the range is reached • There is a wide range of PRF settings for each flow sensitivity selection.
Wall Filter		<p><i>Note: This menu option is available in Color and in CPD on select transducers.</i></p> <p>Select the desired wall filter setting from the on-screen menu: low, med, high.</p>
Steering		<p><i>Note: This menu option is available only on select transducers.</i></p> <p>Select the desired steering angle setting from the on-screen menu. This automatically changes pulsed wave (PW) Doppler angle correction to the optimum setting.</p> <ul style="list-style-type: none"> • Steering angle of -15 degrees has an angle correction of -60 degrees. • Steering angle of 0 degrees has an angle correction of 0 degrees. • Steering angle of +15 degrees has an angle correction of +60 degrees. <p>If two modes are active (CPD/Color and PW/CW Doppler) press the Select key to toggle between the on-screen menus.</p>
Variance		<p><i>Note: This menu option is available only for cardiac exams.</i></p> <p>Select Variance from the on-screen menu to turn on.</p>
Invert		<p>Select Invert from the on-screen menu to switch the displayed direction of flow.</p> <p>Invert is only displayed when Color is selected.</p>
Gain		<p>Turn the Gain knob (on the lower left side of the control panel) to increase or decrease the amount of color gain applied to the CPD or Color ROI box. While in CPD or Color imaging, Near and Far knobs affect only the 2D image.</p>
2D Imaging		<p>Press the 2D or Color key to return to 2D imaging.</p> <p>If two modes are active (CPD/Color and PW Doppler) press the Select key to toggle between on-screen menus.</p>

Pulsed Wave (PW) and Continuous Wave (CW) Doppler Imaging

Note: PW Doppler and CW Doppler are optional features and depend on transducer and exam type. The following instructions cover PW and CW Doppler imaging.

Doppler D-Line

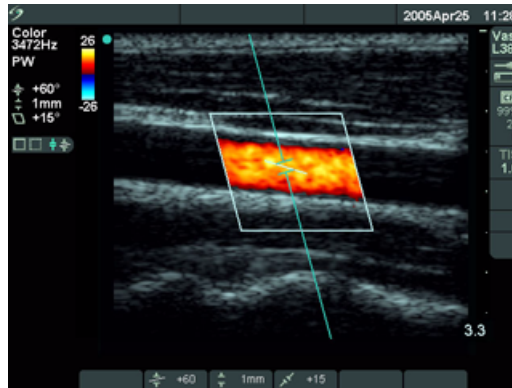

Figure 6 Doppler with D-Line Image and ROI Box

D-Line



- 1 Press the **Doppler** key for the D-line.
- 2 Use the **Touchpad** to position the D-line over the area of interest on the image.
- 3 Press the **Select** key to set the D-line and to toggle between the D-line and angle correction.
 - An indicator on the left side of the screen is highlighted green to show which function the touchpad is controlling.
 - If PW or CW Doppler mode does not come on, make sure the system is in live imaging.
 - The color ROI box is tied to the D-line.

PW/CW Doppler

Note: CW Doppler is available only in cardiac exams.

- 1 Press the **Doppler** key.
- 2 Select **PW** from the on-screen menu to toggle between PW Doppler and CW Doppler.

Angle Correction

Note: This menu option is available only in PW Doppler.

There are two ways to adjust the angle correction in PW Doppler imaging. Select Angle Correction from the on-screen menu to adjust the angle correction to **0**, **+60**, or **-60** degrees.

OR

- 1 Press the **Select** key to highlight angle correction and to toggle between the D-line and angle correction.
An indicator on the left side of the screen is highlighted green to show which function the touchpad is controlling.
 - 2 Use the **Touchpad** to adjust the angle in two degree increments from -74 to +74 degrees.
 - 3 Press the **Select** key again to set the desired angle.
-

Gate Size

Note: This menu option is available only in PW Doppler.

Select the desired gate size setting from the on-screen menu.

- A beep sounds when the minimum or maximum of the range is reached.
 - Gate size options vary with transducer and exam type.
-

Tissue Doppler Imaging (TDI)

Note: This menu option is available only in PW Doppler and cardiac exams.

Select **TDI** from the on-screen menu to turn on tissue Doppler imaging.

- TDI displays in the upper left corner of the screen when TDI is on.
 - The default for TDI is off.
-

Doppler Gate Depth

Note: This menu option is available only in TCD/Orb exams.

- 1 Locate the Doppler gate depth indicator at the bottom right of the screen.

Doppler gate depth measures the depth of the center of the gate in the Doppler image.

- 2 Use the **Touchpad** to select the desired depth.
-

Steering

Note: This menu option is available only on select transducers.

Select the desired steering angle setting from the on-screen menu.

This automatically changes PW angle correction to the optimum setting.

- Steering angle of -15 degrees has an angle correction of -60 degrees.
- Steering angle of 0 degrees has an angle correction of 0 degrees.
- Steering angle of +15 degrees has an angle correction of +60 degrees.

The angle correction can be adjusted manually after steering has been selected. (See "[Angle Correction](#).")

If two modes are active (CPD/Color and PW/CW Doppler) press the **Select** key to toggle between on-screen menus.

Doppler Spectral Trace

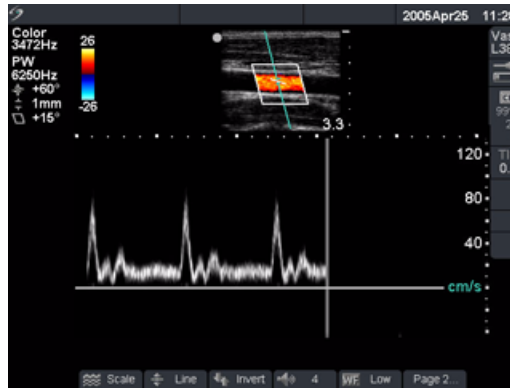









Figure 7 Doppler Trace Image

Spectral Trace	<ol style="list-style-type: none"> 1 Press the Doppler key again to acquire the Doppler trace. 2 Press the Update key to toggle between the 2D/D-line and trace. 3 In duplex, press the Doppler key to return to the full screen D-line. <ul style="list-style-type: none"> • The time scale at the top of the trace has small marks at 200 ms intervals and large marks at one second intervals. • You can choose from one of three screen layouts. For duplex imaging see “Duplex” on page 45. 	
Scale		Select the desired scale/pulse repetition frequency (PRF) setting from the on-screen menu. A beep sounds when the minimum or maximum of the range is reached.
Line		Select the desired baseline position from the on-screen menu. Baseline can be adjusted on a frozen trace if Live Trace is not displayed.
Invert		Select Invert from the on-screen menu to vertically flip the spectral trace. Invert can be adjusted on a frozen trace if Live Trace is not displayed.
Volume		Select the desired Doppler volume setting from the on-screen menu to increase or decrease Doppler speaker volume (0-10). A beep sounds when the minimum or maximum of the range is reached.
Wall Filter		Select the desired wall filter setting from the on-screen menu: low, med, high .
Sweep Speed		Select the desired sweep speed from the on-screen menu: slow, med, fast .
Live Trace		Select Trace from the on-screen menu to display a live trace of the peak or mean. See “ Live Trace ” on page 45.
Gain		Turn the Gain knob to increase or decrease the amount of Doppler gain.

Freeze	<ol style="list-style-type: none"> 1 Press the Freeze key. The cine icon is displayed in the system status area of the screen. 2 Press the Freeze key again to return to live imaging. The cine icon is removed from the system status area of the screen and live imaging resumes.
Cine Buffer 	On a frozen image, press the Cine keys to view the trace at different points in time.
2D Imaging	Press the 2D key to return to 2D imaging.

Clips

Note: This feature is optional.

Time/ECG	<p>Select Clips from the on-screen menu.</p> <ul style="list-style-type: none"> • Select Time from the on-screen menu if desired acquisition is based on number of seconds. Select the desired time duration: 2s, 4s, 6s. • Select ECG from the on-screen menu if desired acquisition is based on the number of heart beats. Select the desired number of beats: 1, 2, 3, 4, 6, 8, 10 beats.
Preview On/Off	<p>Select PrevOn from the on-screen menu to turn on the preview feature and select PrevOff to turn off preview feature.</p> <ul style="list-style-type: none"> • When Prev/On is selected, the Save Clip key automatically plays the acquired clip on the screen rather than storing to the CompactFlash card. • Only in Prev/On can the clip be trimmed, saved, or deleted. • When Prev/Off is selected, the clip is automatically saved and the trim and delete features are not available.
Prospective/ Retrospective	<p>Select Pro from the on-screen menu to acquire clips prospectively or select Retro to acquire clips retrospectively.</p> <ul style="list-style-type: none"> • If Pro is selected, a clip is acquired after the Save Clip key is pressed. • If Retro is selected, a clip is acquired from pre-saved data before the Save Clip key is pressed.
Save Clip	<ol style="list-style-type: none"> 1 Select Clips from the on-screen menu. 2 Select clip settings as desired. To trim a clip, Prev/On must be selected at this point. 3 Press the Save Clip key. The clip is saved to CompactFlash card or plays back depending on the preview setting selected.

Trim Clip	<p>Frames from the left and right ends of the clip can be removed.</p> <ol style="list-style-type: none"> 1 Select Clips from the on-screen menu. 2 Select PrevOn from the on-screen menu. 3 Press the Save Clip key. The clip is taken when a beep sounds and the clip is displayed in preview mode. 4 Select Left: x from the on-screen menu to remove frames from the left side of the clip. The number displayed represents the beginning frame number. 5 Select Right: x from the on-screen menu to remove frames from the right side of the clip. The number displayed represents the ending frame number. 6 Select Save from the on-screen menu.
------------------	---

Delete Clip	Select Delete from the on-screen menu to delete a clip before saving to Patient List.
--------------------	--

Clip Acquisition Delay

Delay		<p><i>Note: This menu option is displayed within the ECG on-screen menu and is only available with the Save Clip option.</i></p> <p>Select Delay from the on-screen menu.</p>
--------------	--	--

Line		Select the desired position of the delay line on the ECG trace. The delay line indicates where the clip acquisition is triggered.
-------------	---	---

Gain		Select the desired gain from the on-screen menu to increase or decrease ECG gain: 0-20 .
-------------	---	---

Save		Saves the current position of the delay line on the ECG trace. You can change the position of the delay line temporarily. Entering a new patient or cycling the system power will revert the delay line to the most-recently saved position.
-------------	--	--

Image and Clip Storage

Save to CompactFlash

Images and clips are saved to the CompactFlash card.

- The images/clips in the patient list are organized alphabetically by the patient name and ID. If a name is not entered in the patient name field, a patient exam is created and identified as (_No_Name_). If an ID number is not entered in the ID field, the ID number is identified as (_No_ID_).
- To review saved images/clips, see ["Image and Clip Review"](#) on page 72. The images/clips saved on the CompactFlash card cannot be opened and viewed on a PC.
- Images may be archived from the ultrasound system using DICOM Image Transfer or to a PC using SiteLink Image Manager. See ["Connectivity and Configuration"](#) on page 141 or the *SiteLink Image Manager User Guide*.
- The number of images/clips saved to the CompactFlash card varies depending on the storage capacity of the card.
- The CompactFlash card is for temporary storage of images and clips. Patient exams should be archived regularly, and old exams deleted from the CompactFlash card. The CF Capacity Alert can be activated to alert when the CF card is near capacity. See ["CF Capacity Alert"](#) on page 34. Storing large numbers of patient exams on the CompactFlash card may increase the time required to save an image or clip.

WARNING: To prevent loss of data, (for example, images/clips), or damage to the CompactFlash card, always turn off the ultrasound system before removing the CompactFlash card.

Caution: If the CompactFlash icon and image and clip counters are not displayed in the system status, the CompactFlash card may be defective. Turn off the system and replace the CompactFlash card.
The CompactFlash card may be restored if it is formatted on a PC. Formatting the card erases all data. However, if the card is physically damaged, formatting does not restore it.

Save

- 1 Verify the CompactFlash card is inserted into the front slot on the ultrasound system. See [Figure 1](#) on page 6.



- 2 Turn on system.

The CompactFlash card is ready to use when the CompactFlash card icon and image and clip counters are displayed. The counters indicate the following states:

- Percent of storage remaining
- Number of stored images
- Number of stored clips
- It may take a few seconds for the image memory counter to display the available memory.
- If the CompactFlash card is inserted into the back slot, the CompactFlash icon and number of stored images and clips are not displayed.



If the CompactFlash card is storing images or clips, the CompactFlash card animation is displayed. While the CompactFlash card animation is being displayed:

- Image review is not available
- Card should not be removed
- System should not be turned off

Save Image

Press the **Save** key to save an image to the CompactFlash card.

- After the audible beep is heard, the next image may be saved. It may take a few seconds for the image to be stored. During this time the CompactFlash card animation is displayed.
- When an image is stored, the image and clip counter increases by one.
- Ensure there is sufficient memory available on the CompactFlash card before saving additional images.
- A maximum of 200 images can be saved for an individual patient exam.

Save Clip

Press the **Save Clip** key to save a clip to the Compact Flash card.

- While the clip is being acquired, the stored clips counter is highlighted. After the audible beep is heard (counter is no longer highlighted), the next clip may be saved. It takes several seconds for the clip to be stored, during which time the CompactFlash card animation is displayed.
- The longer the clip and the more frequently clips are saved, the longer it takes to store all clips.
- When a clip is stored, the clip counter increases by one.
- Ensure there is sufficient memory available on the CompactFlash card before saving.

Print to Local Printer

Ensure the printer is properly set up for operation with the system. See “Printer” on page 33 for system setting and the applicable SonoSite accessory user guide for hardware setup.

Print Image Press the **Print** key.

Image and Clip Review

The patient list displays all the patients who have images/clips saved on the CompactFlash card. Image/clip review is comprised of two parts: the patient list and the patient images. The patient images display images/clips for the current patient or the patient selected from the patient list.

Patient List

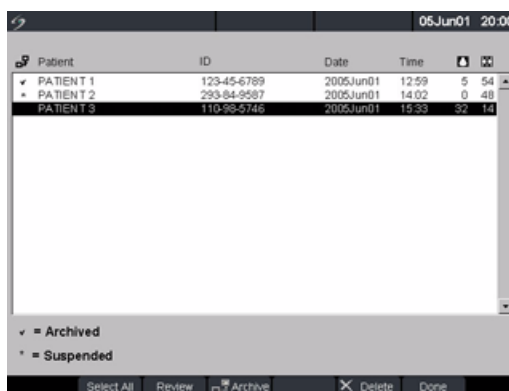

Figure 8 Patient List

Patient List

Press the **Review** key. If there is a current patient, select **List** from the on-screen menu.

The number of saved images and clips is displayed on the patient list.

Select All, Deselect

Select All from the on-screen menu to highlight all the entries within the patient list.

- Deselect removes the highlight from all the entries and highlights the previously selected patient.
- Review is disabled when all entries in the list are selected.

Review Images



Select **Review** from the on-screen menu to review the images for the currently selected patient.

Archive







Note: SiteLink and DICOM are optional features.

Select **Archive** from the on-screen menu to send the selected patient exams to a PC using SiteLink or to a DICOM printer or archiver. See “Transfer Mode” on page 34.

Print All Images 	<ol style="list-style-type: none"> 1 Verify a printer is selected. See “Printer” on page 33. 2 Press the Review key. 3 Select List from the on-screen menu. 4 Highlight the desired patient. An individual patient or all patients may be selected. 5 Select Print from the on-screen menu to print all images. Each image displays briefly on the screen before printing starts.
Delete 	Select Delete from the on-screen menu to delete the selected patient exam. A confirmation screen is displayed.
Done	Select Done from the on-screen menu to exit the patient list and return to the previous imaging state.

Patient Images and Clips

Patient Images	<p>Press the Review key.</p> <p>If there is not a current patient, highlight the desired patient and select Review from the on-screen menu.</p>
Next or Previous Image/Clip 	Select the (1/x) from the on-screen menu to view image/clip.
Play	<p>If a clip, select Play from the on-screen menu to review the clip.</p> <p>Select Pause to freeze the clip.</p> <ul style="list-style-type: none"> • The load time varies depending on the length of the clip. • The clip plays automatically after loading.
Playback Speed 	Select the desired playback speed from the on-screen menu: 1x, 1/2x, 1/4x.
Patient List 	Select List from the on-screen menu to display the patient list.
Print Image 	<ol style="list-style-type: none"> 1 Verify a printer is selected. See “Printer” on page 33. 2 Select Print from the on-screen menu to print the displayed image.
Delete 	Select Delete from the on-screen menu to delete the displayed image/clip. A confirmation screen is displayed.
Done	Select Done from the on-screen menu to exit patient images/clips and return to the previous imaging state.

Annotations

Annotations are available in both live imaging and on a frozen image. You cannot annotate on a saved image. Text entry and predefined labels are available within the image area.

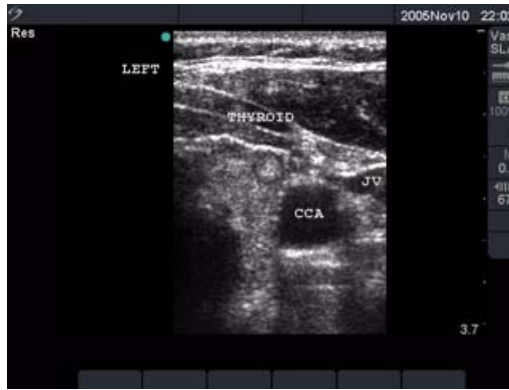

Figure 9 Image with Predefined Labels

Enter Text

- 1 Press the **Text** key.
- 2 Use the **Touchpad** or arrows to position the text cursor anywhere within the image area.
- 3 Use the keyboard to enter, delete, or modify text.
 - Press the **Backspace** key to delete characters to the left of the cursor.
 - Press the **Spacebar** key to add spaces between words or replace characters with blank spaces to the right of the cursor.
 - Press the **Arrow** keys to move the cursor to the left, right, up, or down.
 - Press the **Enter** key to move the cursor to the next line.
 - Select **Delete Word** from the on-screen menu to remove the word.
 - Press the **Text** key to turn off text entry.

Text can be inserted on the following imaging layouts: full screen 2D, full screen trace, dual, or duplex.

Home/Set

- 1 Press the **Text** key.
- 2 Use the **Touchpad** or arrows to position the text cursor to the desired location.
- 3 Select **Home/Set** from the on-screen menu.
The new location is now the home position for the text cursor.
- 4 To reset the home position, reposition the cursor and select **Home/Set** from the on-screen menu.

Home	<ol style="list-style-type: none">1 Press the Text key.2 Select Home from the on-screen menu to move the cursor to the original home position (upper left).<ul style="list-style-type: none">• The home position can be set to a new location. To change the home position, see “Home/Set” on page 74.• The factory default home position is different depending on the imaging screen layout.
-------------	--

Label	<ol style="list-style-type: none">1 Press the Text key.2 Use the Touchpad to set the cursor on the desired location on the image.3 Select Label from the on-screen menu.4 Select the desired label group (1/x) to insert the appropriate label.<ul style="list-style-type: none">• There are three label groups. See “Annotations” on page 36.• Predefined labels can be inserted on the following imaging layouts: full screen 2D, full screen trace, dual, or duplex.
--------------	---

Symbols	Select Symbols from the on-screen menu to enter special characters. See “Symbols” on page 23.
----------------	--

Delete Word	Select Delete Word from the on-screen menu repeatedly to clear the screen of text a word at a time. Words are deleted in sequence, right to left, and bottom to top.
--------------------	---

Delete	Press the Delete key to clear the screen of all text at once. Preset delete options to save or delete text when unfreezing an image. See “Unfreeze” on page 37 for information on presetting options when unfreezing an image.
---------------	--

Arrow	 <ol style="list-style-type: none">1 Press the Arrow key. Use the arrow as a pointer to bring attention to a specific part of the image.2 Use the Touchpad to move the arrow over the image.3 Press the Select key to switch the arrow’s orientation and then use the Touchpad to adjust the arrow’s orientation.4 Press the Select key again to set the arrow’s orientation and then use the Touchpad to move the arrow over the image.5 Press the Arrow key to set the arrow.<ul style="list-style-type: none">• The arrow changes from green to white.• To remove the arrow from the image, press the Arrow key and then select Hide from the on-screen menu.
--------------	---

Pictograph

- 1 Press the **Picto** key to turn on the pictograph. The on-screen options for pictograph are:
 -  Show/Hide
 - Number (for example, 1/18)
 - Location on screen (U/L, D/L,D/R, U/R)
 - Done
- 2 Select the desired pictograph.
 - The first number changes to show which pictograph in a set of pictographs has been selected. The second number shows the total number of pictographs available.
 - The pictograph set that is available depends on transducer and exam type.
- 3 Use the **Touchpad** to position the pictograph marker.
- 4 Press the **Select** key and then use the **Touchpad** to rotate the pictograph marker.
- 5 Select one of four image positions from the on-screen menu to move the pictograph to the desired location: **U/L, D/L, D/R, U/R**.
 - In Duplex, the pictograph is restricted to the upper left position.
 - In Dual, all four positions are available.
- 6 Select **Hide** from the on-screen menu to remove the pictograph.



ECG Monitoring

Note: ECG Monitoring is an optional feature and requires a SonoSite ECG cable.

WARNING: To prevent misdiagnosis, do not use the ECG trace to diagnosis cardiac rhythms. The SonoSite ECG option is a non-diagnostic feature.

To prevent misdiagnosis, do not use the SonoSite ECG option for long term cardiac rhythm monitoring.

Caution: Use only accessories recommended by SonoSite with the system. Your system can be damaged by connecting an accessory not recommended by SonoSite.

ECG		This menu option is displayed only when the ECG cable is connected. If SonoMB is available on the transducer, ECG monitoring is not available.
		<ol style="list-style-type: none"> 1 Connect the ECG cable to the ECG connector on the mini-dock or docking system. <ul style="list-style-type: none"> • When the ECG cable is connected, ECG monitoring turns on automatically. • An external ECG monitor may cause a lag in the timing of the ECG trace, corresponding with the 2D image. • Biopsy guidelines are not available when ECG is connected. 2 Select ECG from the on-screen menu.
Show/Hide		Select Show/Hide from the on-screen menu to turn on/off ECG trace.
Gain		Select the desired gain from the on-screen menu to increase or decrease ECG gain: 0-20 .
Position		Select the desired position of the ECG trace from the on-screen menu.
Sweep Speed		Select the desired sweep speed from the on-screen menu: slow, med, fast .

Footswitch

Note: The footswitch is an optional feature and requires a SonoSite footswitch.

WARNING: To avoid contamination, do not use the footswitch in a sterile environment. The footswitch is not sterilized.

Connect Footswitch	<ol style="list-style-type: none"> 1 Connect cables: <ul style="list-style-type: none"> • Y adapter cable to the ECG connector on the mini-dock or docking system. • Footswitch cable to Y adapter cable 2 Select the desired functionality for the left and right footswitches. See "Footswitch" on page 46.
---------------------------	--

Bar Code Scanner

- Connect Bar Code Scanner**
- 1 Ensure that the mini-dock is connected to the system.
 - 2 Connect cables:
 - Bar code scanner interface cable to bar code scanner adapter
 - Bar code scanner adapter to mini-dock
 - Power supply cable to bar code scanner interface cable
 - Power cord to bar code scanner power supply
 - Power cord to power strip
 - Connect system power cord to a hospital-grade electrical outlet.
 - 3 Select Bar Code Scanner for serial port connectivity. See [“Serial Port”](#) on page 33.

Needle Guidance

Note: The biopsy and needle guide features depend on transducer type.

The ultrasound system is equipped with a needle guidance feature. For detailed instructions on the use of the system, needle guidance accessories, and a list of compatible transducers, see the user guides for Biopsy and L25 Bracket and Needle.

Chapter 4: Measurements and Calculations

Measurements

Measurements and calculations are performed on frozen images. The following sections explain how to perform basic measurements in each imaging mode. Based on the measurements performed, the SonoSite system automatically calculates specific information and displays the results. Some of the options described in the user guide may not apply to your system. System features are dependent on your configuration, transducer, and exam type.

2D Measurements

The basic measurements that can be performed in 2D are:

- Distance in cm
- Area in cm^2
- Circumference in cm

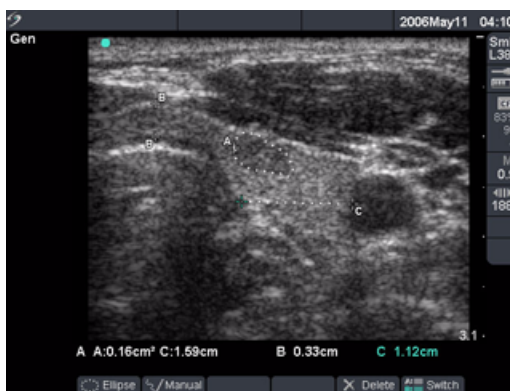





Figure 1 2D Measurement with Two Linear and One Trace

Distance Measurement

- 1 On a frozen 2D image, press the **Caliper** key.
 - A set of calipers and the following on-screen menu options are available:
 -  Ellipse (circumference/area)
 -  Manual trace
 -  Delete
 - The two calipers are connected by a dotted line. When the calipers get close together, they decrease in size and the caliper line is removed.
- 2 Use the **Touchpad** to position the first caliper.
- 3 Press the **Select** key to activate the other caliper.

The result is displayed in the measurement and calculation data area and is updated as the caliper moves. The measurement is complete when you finish moving the calipers.
- 4 Press the **Caliper** key to activate each additional caliper set.
 - The active caliper is highlighted green.
 - Up to eight calipers are available for distance measurements.
 - A combination of distance, area/circumference, and trace measurements can be performed at the same time.
 - The number of measurements available depends on the order and types of measurements. See [“Area/ Circumference Measurement”](#) on page 81 and [“Manual Trace”](#) on page 82 for more information.
-  5 Select **Switch** from the on-screen menu to move between caliper sets.
- 6 To save the highlighted measurement to a calculation, press the **Calcs** key, select the appropriate measurement label, then select **Save** from the on-screen menu.

The measurement is saved to the patient report only if a label can be applied to it.

**Area/
Circumference
Measurement**



- 1 On a frozen 2D image, press the **Caliper** key.
- 2 Select **Ellipse** from the on-screen menu.
- 3 Press the **Select** key to activate the calipers and use the **Touchpad** to adjust the size and position of the ellipse.
 - The active caliper is highlighted green.
 - The result is displayed in the measurement and calculation data area and is updated as the caliper moves. The measurement is complete when you finish moving the calipers.
- 4 Press the **Caliper** key to activate additional caliper sets.
 - A combination of distance, area/circumference, and trace measurements can be performed at the same time.
 - The number of measurements available depends on the order and types of measurements.
 - If you exceed the allowed combination of measurements for an image, Ellipse is not shown on the on-screen menu.



- 5 Select **Switch** from the on-screen menu to move between measurements.
- 6 To save the highlighted measurement to a calculation, press the **Calcs** key, select the appropriate measurement label, then select **Save** from the on-screen menu.

The measurement is saved to the patient report only if a label can be applied to it.

Manual Trace



- 1 On a frozen 2D image, press the **Caliper** key.
- 2 Select **Manual** from the on-screen menu.
- 3 Use the **Touchpad** to position the caliper at the trace start point.
- 4 Press the **Select** key to start the tracing function.
- 5 Use the **Touchpad** to complete the trace and select **Set** from the on-screen menu.

The result is displayed in the measurement and calculation data area.
- 6 Press the **Caliper** key to activate additional caliper sets.
 - A combination of distance, area/circumference, and trace measurements can be performed at the same time.
 - The number of measurements available depends on the order and types of measurements.
 - If you exceed the allowed combination of measurements for an image, Manual is not shown on the on-screen menu.
- 7 Select **Switch** from the on-screen menu to move between measurements.
- 8 To save the highlighted measurement to a calculation, press the **Calcs** key, select the appropriate measurement label, then select **Save** from the on-screen menu.

The measurement is saved to the patient report only if a label can be applied to it.



Edit Measurement



- 1 Select **Switch** from the on-screen menu until the desired measurement is highlighted.
- 2 Move the caliper to the desired position.
 - The result displayed in the measurement and data area is updated.
 - Trace measurements in 2D or Doppler can not be edited once set.

Delete Measurement

- 1 Select **Switch** from the on-screen menu until the desired measurement is highlighted.
- 2 Select **Delete** from the on-screen menu.

The highlighted measurement is removed from the screen and the most-recent previous measurement is highlighted.

M Mode Measurements

The basic measurements and calculations that can be performed in M Mode are:

- Distance in cm
- Time in seconds
- Heart Rate (HR) in beats per minute (bpm)

The time scale at the top of the trace has small marks at 200 ms intervals and large marks at one second intervals.





Figure 2 M Mode Trace Image with Heart Rate

Distance Measurement

- 1 On a frozen M Mode trace, press the **Caliper** key.
A single caliper is displayed on the screen and the following on-screen menu options are available:
 - ♥ Heart rate (HR)
 - ✕ Delete
- 2 Use the **Touchpad** to position the first caliper.
- 3 Press the **Select** key to display the second caliper.
 - The active caliper is highlighted green.
 - Up to four distance measurements can be performed on an image.
 - Select **Switch** from the on-screen menu to move between measurements.
- 4 To save the highlighted measurement to a calculation, press the **Calcs** key, select the appropriate measurement label, then select **Save** from the on-screen menu.
The measurement is saved to the patient report only if a label can be applied to it.

**Heart Rate (HR)
Fetal Heart Rate
(FHR)**

- 1 On a frozen M Mode trace, press the **Caliper** key for HR or press the **Calcs** key for FHR (OB exam only).
The following on-screen menu options are available:
 -  Heart rate (HR)
 -  Delete
 -  Save
- 2 Select **HR** from the on-screen menu or select **FHR** from the calculation menu.
A vertical caliper is displayed on the screen.
- 3 Use the **Touchpad** to position the first vertical caliper at the peak of the heart beat.
- 4 Press the **Select** key.
 - A second vertical caliper is displayed on the screen.
 - The active caliper is highlighted green.
- 5 Use the **Touchpad** to position the second vertical caliper at the peak of the next heart beat.
- 6 Select **Save** from the on-screen menu to save the HR measurement to the patient report.
 - This overwrites the previous heart rate value entered under exam/patient information.
- 7 If desired, press the **Save** key to save the image with the measurements displayed.

**Delete
Measurement**

- Select **Delete** from the on-screen menu.
This removes the HR measurement from the screen.

Doppler Measurements

Inspect the auto trace to confirm that the system-generated boundary is correct. If you are not satisfied with the auto trace, obtain a high-quality Doppler trace or use the manual measurement tool.

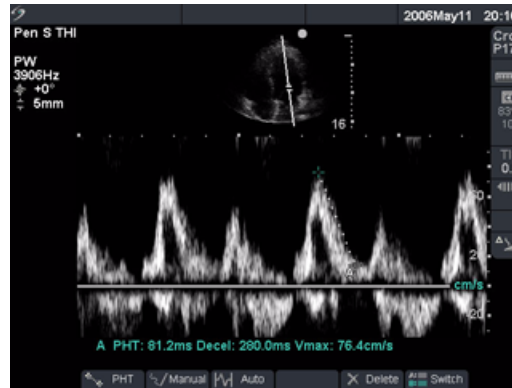









Figure 3 Doppler Trace with Two Velocity Measurements

Velocity (cm/s), Pressure Gradient

Note: The Doppler scale must be set to cm/s for the following measurements. See “System Setup” on page 24.

- 1 On a frozen Doppler spectral trace, press the **Caliper** key.
A single caliper is displayed on the screen with the following on-screen menu options:
 -  PHT (cardiac exam only)
 -  Manual (trace)
 -  Auto
 -  Delete
- 2 Use the **Touchpad** to position the active green caliper to a peak systolic wave form.
This is a single caliper from the baseline.
- 3 If desired, press the **Save** key to save the image with the measurements displayed.
- 4 To save the highlighted measurement to a calculation, press the **Calcs** key, select the appropriate measurement label, then select **Save** from the on-screen menu.
The measurement is saved to the patient report only if a label can be applied to it.

**Velocities,
Elapsed Time,
+/- Ratio,
Resistive Index (RI),
Acceleration**

- 1 On a frozen Doppler spectral trace, press the **Caliper** key.
A single caliper is displayed on-screen with the following menu options:
 -  Manual (trace)
 -  Auto
 -  Delete
- 2 Use the **Touchpad** to position the first caliper to a peak systolic wave form.
- 3 Press the **Caliper** or **Select** key.
A second caliper is displayed on the screen.
- 4 Use the **Touchpad** to position the second caliper at the end diastole on the wave form.
- 5 If desired, press the **Save** key to save the image with the measurements displayed.
- 6 To save the highlighted measurement to a calculation, press the **Calcs** key, select the appropriate measurement label, then select **Save** from the on-screen menu.
The measurement is saved to the patient report only if a label can be applied to it.

Trace Measurements

Manual Trace



- 1 On a frozen Doppler spectral trace, press the **Caliper** key.
 - 2 Select **Manual** from the on-screen menu.
A single caliper is displayed on the screen.
 - 3 Use the **Touchpad** to position the caliper at the beginning of the desired wave form and press the **Select** key.
If calipers are not placed in the correct position, the calculation is not performed accurately.
 - 4 Use the **Touchpad** to move the caliper to trace the wave form.
If an error is made, do one of the following to remove the caliper points:
 - Use the **Touchpad** to backtrack caliper over caliper points.
 - Press **Backspace** key.
 - Select **Undo** from the on-screen menu.
 - 5 Select **Set** from the on-screen menu to complete the trace and display the results.
 - 6 Press the **Save** key to save an image of the trace with the results displayed.
 - 7 To save the highlighted measurement to a calculation, press the **Calcs** key, select the appropriate measurement label, then select **Save** from the on-screen menu.
The measurement is saved to the patient report only if a label can be applied to it.
-

Automatic Trace

- 1 On a frozen Doppler spectral trace, press the **Caliper** key.
- 2 Select **Auto** from the on-screen menu.
A vertical caliper is displayed.
- 3 Use the **Touchpad** to position the first caliper at the beginning of the wave form.
- 4 Press the **Select** key.
 - A second vertical caliper is displayed.
 - If calipers are not placed in the correct position, the calculation is not performed accurately.
- 5 Use the **Touchpad** to position the second caliper at the end of the wave form.
- 6 Select **Set** from the on-screen menu to complete the trace and to display the results.
- 7 To save the highlighted measurement to a calculation, press the **Calcs** key, select the appropriate measurement label, then select **Save** from the on-screen menu.
The measurement is saved to the patient report only if a label can be applied to it.

The following table shows the auto trace results displayed by exam type:

Table 1: Auto Trace Results by Exam Type

Auto Trace Results	Cardiac	TCD/ Orb	Vascular	OB/Gyn	Abdomen	Neo
Velocity Time Integral (VTI)	X	—	—	—	—	—
Peak Velocity (Vmax)	X	—	X	X	X	—
Mean Pressure Gradient (PGmean)	X	—	—	—	—	—
Mean Velocity on Peak Trace (Vmean)	X	—	—	—	—	—
Pressure Gradient (PGmax)	X	—	—	—	—	—
Cardiac Output (CO)	X	—	—	—	—	—
Peak Systolic Velocity (PSV)	—	X	—	—	—	X
Time Average Mean (TAM)*	—	X	—	—	—	X
+/- or Systolic/Diastolic (S/D)	—	X	X	X	X	X
Pulsatility Index (PI)	—	X	X	X	X	X
End Diastolic Velocity (EDV)	—	X	X	X	X	X
Acceleration Time (AT)	—	—	—	—	X	—
Resistive Index (RI)	—	X	X	X	X	X
Time Average Peak (TAP)	—	X	—	—	—	X
Gate Depth	—	X	—	—	—	X

*Note: The automatic trace tool must be used to calculate the TAM**

Calculations

Calculations may be performed and results saved to the patient report. Measurements may also be viewed, repeated, and deleted. Some measurements can be deleted from the report pages. See “Patient Report” on page 135.

Perform Measurement	<ol style="list-style-type: none">1 Select a measurement from the calculations menu by highlighting the desired measurement then pressing the Select key.2 Perform the measurement.<ul style="list-style-type: none">• The measurement is displayed in the measurement and calculation data area and is updated as the caliper moves.• The measurement is complete when you finish moving the calipers.3 Select Save from the on-screen menu to save the measurement to the patient report.
View or Repeat Saved Measurement	<ol style="list-style-type: none">1 From the calculations menu, select the desired measurement. The saved measurement is displayed at the bottom of the calculation menu.2 Press the Select key or the Caliper key to select the measurement.3 Repeat the measurement.<ul style="list-style-type: none">• The new results are displayed in the measurement and calculation data area.• You can compare the active measurement to the saved measurement.4 To save the new measurement, select Save from the on-screen menu or press the Enter key. This saves the new measurement to the patient report and overwrites the previously saved measurement.
Delete Measurement	<ol style="list-style-type: none">1 From the calculations menu, select the desired measurement.2 Select Delete from the on-screen menu.<ul style="list-style-type: none">• This removes the last saved measurement from the patient report.• Some measurements can be deleted from the report pages. See “Patient Report” on page 135.

Percent Reduction Calculations

WARNING: Verify that the patient information, date, and time settings are accurate.
Before starting a new calculation, start a new patient exam to delete the previous measurements. See “New Patient” on page 49.

Percent reduction calculations may be performed and saved to the patient report. The following table shows the transducers and exam types that provide vascular percent reduction calculations.

Table 2: Transducer and Exam Types for Percent Reduction

Transducer	Exam Types
C11e	Abdomen
C60e	Abdomen
HFL38	IMT, Small Parts, Vascular
L25e	Vascular, Muscle
L38e	IMT, Small Parts, Vascular
P17	Abdomen
P10	Vascular, Abdomen
SLA	Vascular, Muscle
SLT	Hepatic, Abdomen

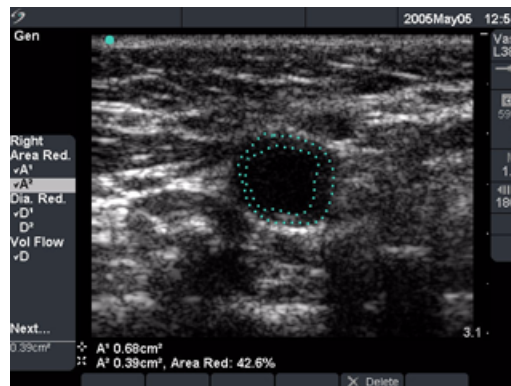

Figure 4 Percent Area Reduction Measurement

**Percent Area
Reduction**

- 1 On a frozen 2D image, press the **Calcs** key.
 - 2 From the calculations menu, select the desired measurement.
 - 3 To perform the first trace, move the caliper to the desired starting point and press the **Select** key to start the tracing function.
 - 4 Use the **Touchpad** to trace the desired area.
If an error is made, select Undo from the on-screen menu to delete the previous position.
 - 5 Complete the trace and select **Set** from the on-screen menu.
 - 6 Select **Save** from the on-screen menu to save the measurement to the patient report.
The saved measurement is displayed at the bottom of the calculation menu and a check mark is put in front of the measurement.
 - 7 Select the next measurement.
 - 8 Perform the next trace.
 - 9 Complete the trace and select **Set** from the on-screen menu.
 - 10 Select **Save** from the on-screen menu to save the measurement to the patient report.
The percent area reduction result is displayed in the measurement and calculation data area and in the patient report.
-

**Percent Diameter
Reduction**

- 1 On a frozen 2D image, press the **Calcs** key.
- 2 From the calculations menu, select the desired measurement.
- 3 Perform the measurement.
- 4 Select **Save** from the on-screen menu, or press the **Enter** key to save the measurement to the patient report.
The saved measurement is displayed at the bottom of the calculation menu and a check mark is put in front of the measurement.
- 5 Select the next measurement.
- 6 Perform the next measurement.
- 7 Select **Save** from the on-screen menu to save the measurement to the patient report.
The percent diameter reduction result is displayed in the measurement and calculation data area and in the patient report.

Volume Calculation

WARNING: Verify that the patient information, date, and time settings are accurate.
Before starting a new calculation, start a new patient exam to delete the previous measurements. See “[New Patient](#)” on page 49.

The following table shows the transducers and exam types that provide a volume calculation.

Table 3: Transducers and Exam Types for Volume

Transducer	Exam Types
C11e	Abdomen, Nerve
C60e	Gyn, Abdomen
HFL38	Breast, Nerve, Small Parts, Vascular
ICT	Gyn
L25e	Nerve, Vascular, Superficial, Muscle
L38e	Breast, Nerve, Small Parts, Vascular
P17	Abdomen
P10	Vascular, Neonatal, Abdomen, Nerve
SLA	Vascular, Superficial, Muscle, Nerve
SLT	Hepatic, Abdomen

The following measurements D^1 D^2 D^3 (2D distance) are required to complete the volume calculation. Volume measurements are performed in 2D mode.

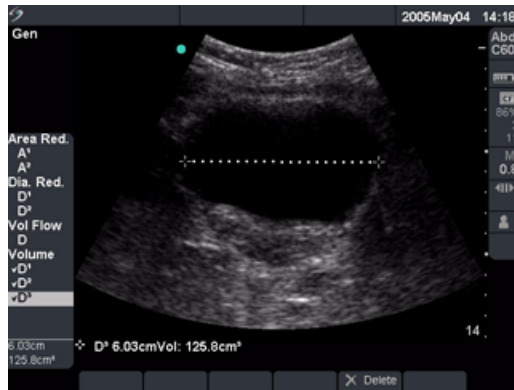

Figure 5 2D Image with Volume Calculation

Volume

Note: D^1 , D^2 , and D^3 are required to complete a volume calculation.

- 1 On a frozen 2D image, press the **Calcs** key.
- 2 From the calculations menu, select the desired measurement.
- 3 Perform the measurement.
- 4 Select **Save** from the on-screen menu, or press the **Enter** key to save the measurement to the patient report.
 - The saved measurement is displayed at the bottom of the calculation menu and a check mark is put in front of the measurement.
 - If desired, press the **Save** key to save the image with the measurements displayed.
- 5 Repeat these steps until all measurements have been performed.

Volume Flow Calculation

WARNING: Verify that the patient information, date, and time settings are accurate. Before starting a new calculation, start a new patient exam to delete the previous measurements. See “[New Patient](#)” on page 49.

The following table shows the transducers and exam types that provide a volume flow calculation.

Table 4: Transducers and Exam Types for Volume Flow

Transducer	Exam Types	Gate Sizes (mm)
C11e	Abdomen	1, 2, 3
C60e	Abdomen	2, 3, 5, 7, 10, 12
HFL38	Vascular	1, 3, 5, 7, 10, 12
L25e	Vascular	1, 3, 5, 7, 10, 12
L38e	Vascular	1, 3, 5, 7, 10, 12
P17	Abdomen,	2, 3, 5, 7, 10, 12
P10	Vascular, Abdomen	2, 3, 5, 7, 10, 12
SLA	Vascular	1, 3, 5, 7, 10, 12
SLT	Hepatic, Abdomen	1, 2, 3, 5, 7, 10

For definitions of acronyms, see “[Glossary](#)” on page 287.

Table 5: Volume Flow Calculation

Measurement	Calculation Result
D (2D distance) TAM (Doppler auto trace)	VF (Volume Flow)

Volume flow measurements are done in 2D and Doppler. Both measurements are required for the volume flow calculation. The Doppler sample volume should completely insonate the vessel.

The following factors should be considered when acquiring volume flow measurements:

- Users should follow current medical practice for volume flow calculation applications.
- The accuracy of the volume flow calculation is largely dependent on the user.
- The factors identified in the literature that affect the accuracy are:
 - Using the diameter method for 2D area
 - Difficulty ensuring uniform insonation of the vessel—The system is limited to the sample volume sizes listed in [Table 4](#).
 - Precision in placing the caliper
 - Accuracy in angle correction

The considerations and degree of accuracy for volume flow measurements and calculations are discussed in the following reference:
Allan, Paul L. et al. *Clinical Doppler Ultrasound*, 4th Ed., Harcourt Publishers Limited, (2000) 36-38.

Volume Flow

2D measurement

- 1 On a frozen full screen 2D image or duplex image, press the **Calcs** key.
- 2 From the calculations menu under **Volume Flow**, select **D** (distance).
- 3 Perform the measurement.
- 4 Select **Save** from the on-screen menu, or press the **Enter** key to save the measurement to the patient report.
 - The saved measurement is displayed at the bottom of the calculation menu and a check mark is put in front of the measurement.
 - If desired, press the **Save** key to save the image with the measurements displayed.

Doppler measurement

- 1 On a frozen Doppler spectral trace or duplex image, press the **Calcs** key.
- 2 From the calculations menu under **Volume Flow**, select **TAM**.
- 3 Press the **Select** key to display the first vertical caliper.
- 4 Use the **Touchpad** to position the first vertical caliper at the beginning of the wave form.
- 5 Press the **Select** key to display the second vertical caliper.
If calipers are not placed in the correct position, the calculation will not be performed accurately.
- 6 Use the **Touchpad** to position the second vertical caliper at the end of the wave form.
- 7 Select **Set** from the on-screen menu to complete the trace and to display the results.
- 8 Select **Save** from the on-screen menu, or press the **Enter** key to save the measurement to the patient report.
 - The saved measurement is displayed at the bottom of the calculation menu and a check mark is put in front of the measurement.
 - To view the volume flow calculation, go to the report. See "[Patient Report](#)" on page 135.
 - If desired, press the **Save** key to save the image with the measurements displayed.

Small Parts Calculations

Small Parts calculations consist of Volume, Hip Angle, and d:D Ratio. For information on volume calculations, see “Volume Calculation” on page 92.

References for measurements and calculations are in Chapter 7, “References.” The following table shows the transducers and exam types that provide Hip Angle and d:D Ratio calculations.

Table 6: Transducers and Exam Type

Transducer	Exam Type
HFL38	Small Parts
L38e	Small Parts

-
- Hip Angle**
- 1 On a frozen 2D image, press the **Calcs** key.
 - 2 From the calculations menu, select **Right** or **Left**.
 - 3 Select **Baseline**.
A baseline is displayed on the screen.
 - 4 Position the baseline and select **Set** from the on-screen menu.
Line A (alpha line) is displayed on the screen.
 - 5 Position Line A and select **Save** from the on-screen menu to save the measurement to the patient report.
Line B (beta line) is highlighted and active.
 - 6 Position Line B and select **Save** from the on-screen menu to save the measurement to the patient report.
 - 7 If desired, press the **Save** key to save the image with the measurements displayed.

-
- d:D Ratio**
- 1 On a frozen 2D image, press the **Calcs** key.
 - 2 From the calculations menu, select **Right** or **Left**.
 - 3 Under **d:D Ratio**, select **Fem Hd** (femoral head).
 - 4 Use the **Touchpad** to position the circle and press the **Select** key to change the circle size.
 - 5 Select **Set** from the on-screen menu.
The baseline is automatically displayed with the left caliper active.
 - 6 Position the caliper and select **Save** from the on-screen menu to save the measurement to the patient report.
 - 7 If desired, press the **Save** key to save the image with the measurements displayed.

Gyn Calculations

WARNING: Verify that the patient information, date, and time settings are accurate.
Before starting a new calculation, start a new patient exam to delete the previous measurements. See “New Patient” on page 49.

References for measurements and calculations are in [Chapter 7, “References.”](#)The following table shows the transducers and exam types that provide Gyn calculations.

Table 7: Transducers and Exam Type

Transducer	Exam Type
C60e	Gyn
ICT	Gyn

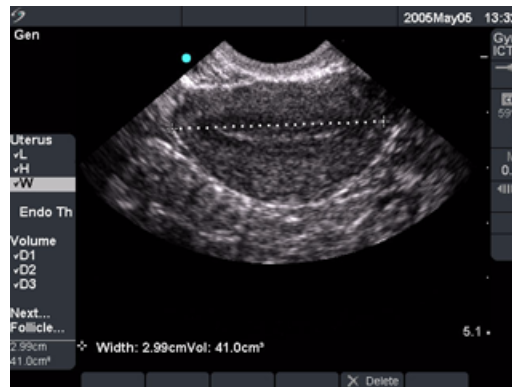

Figure 6 Gyn Measurements

Gyn

- 1 Select **Gyn** exam type.
- 2 On a frozen 2D image, press the **Calcs** key.
- 3 From the calculations menu, select **Gyn** then select the desired measurement.
- 4 Perform the measurement.
- 5 Select **Save** from the on-screen menu, or press the **Enter** key to save the measurement to the patient report.
 - The saved measurement is displayed at the bottom of the calculation menu and a check mark is put in front of the measurement.
 - If desired, press the **Save** key to save the image with the measurements displayed.
- 6 Select the next measurement.
- 7 Repeat these steps until all measurements are performed.



Figure 7 Follicle Measurements

Follicle

Note: You may save up to six follicular measurements. One distance measurement is provided for each follicle.

- 1 Select **Gyn** exam type.
- 2 On a frozen 2D image, press the **Calcs** key.
- 3 From the calculations menu, select **Follicle**, then select the desired measurement.
- 4 Perform the measurement on the first follicle.
- 5 Select **Save** from the on-screen menu, or press the **Enter** key to save the measurement to the patient report.
 - The saved measurement is displayed at the bottom of the calculation menu and a check mark is put in front of the measurement.
 - If desired, press the **Save** key to save the image with the measurements displayed.
- 6 Select the next measurement.
- 7 Repeat these steps until all measurements are performed.

OB Calculations

Note: EFW is only calculated once appropriate measurements are completed. If any one of these parameters results in a EDD greater than what the OB tables provide, the EFW will not be displayed.

WARNING:	<p>Make sure you have selected the OB exam type and the OB calcs author for the OB table you intend to use. See Table 10, “System-Defined OB Calculations and Table Authors” on page 102.</p> <p>In OB exams, an accurate date and time are critical for accurate obstetrics calculations. Verify that the date and time are accurate before each use of the system. The system does not automatically adjust for daylight savings time changes.</p> <p>Verify that the patient information, date, and time settings are accurate.</p> <p>Before starting a new calculation, start a new patient exam to delete the previous measurements. See “New Patient” on page 49.</p> <p>Prior to use, verify OB custom table data entries are correct. The system does not confirm the accuracy of the custom table data entered by the user.</p>
-----------------	---

References for measurements and calculations are in [Chapter 7, “References.”](#) The following table shows the transducers and exam types that provide OB calculations.

Table 8: Transducers and Exam Type

Transducer	Exam Type
C60e	OB
ICT	OB
P17	OB

The following terms describe the measurements and calculations performed by the system.

Table 9: OB Calculation Terms

Acronym	Definition
AUA	The AUA (Average Ultrasound Age) is calculated by averaging the individual ultrasound ages for the fetal biometry measurements performed during the exam. The measurements used to determine the AUA are based on the selected OB calculation authors.
EDD by AUA	The EDD by AUA (Estimated Date of Delivery by Average Ultrasound Age) is the estimated date of delivery calculated from the measurements performed during the exam.

Table 9: OB Calculation Terms (Continued)

Acronym	Definition
EDD by LMP	The EDD by LMP (Estimated Date of Delivery by Last Menstrual Period) is the due date calculated from the user entered LMP.
EFW	The EFW (Estimated Fetal Weight) is calculated from the measurements performed during the exam. The measurements used to determine EFW are defined by the currently selected EFW calculation author.
Estab. DD	The Estab. DD (Established Due Date) is a user-entered due date based on previous exam data or other available information. The LMP is derived from the Established Due Date and is listed in the patient report as LMPd.
GA by LMP	The GA (Gestational Age by Last Menstrual Period) is the fetal age calculated using the date of the Last Menstrual Period (LMP).
GA by LMPd	The GA (Gestational Age by derived Last Menstrual Period) is the fetal age calculated using the Last Menstrual Period (LMPd) derived from the Established Due Date.
LMP	The LMP (Last Menstrual Period) is the first day of the Last Menstrual Period and is used to calculate gestational age and EDD.
LMPd	The LMPd (derived Last Menstrual Period) is calculated from the user-entered Established Due Date (Estab. DD).
UA	The UA (Ultrasound Age) is calculated on the mean measurements taken for a particular fetal biometry.

If you change the calculation author during the exam, the common measurements are retained. The following table shows the system-defined measurements available for OB calculations by author. For descriptions of the acronyms, see [“Glossary” on page 287.](#)

Table 10: System-Defined OB Calculations and Table Authors

Calculation Result	Gestational OB Measurements	Table Authors
Gestational Age (See note 1)	GS	Hansmann Nyberg Tokyo U.
	CRL	Hadlock Hansmann Osaka Tokyo U.
	BPD	Chitty Hadlock Hansmann Osaka Tokyo U.
	OFD	Hansmann
	HC	Chitty Hadlock Hansmann
	TTD	Hansmann Tokyo U.*
	APTD	Tokyo U.*
	AC	Hadlock Hansmann Tokyo U.
	FTA	Osaka
	FL	Chitty Hadlock Hansmann Osaka Tokyo U.

* For Toyko U, APTD and TTD are only used to calculate EFW. No age or growth tables are associated with these measurements.

Table 10: System-Defined OB Calculations and Table Authors (Continued)

Calculation Result	Gestational OB Measurements	Table Authors
Estimated Fetal Weight (EFW) (See notes 2 and 3)	HC, AC, FL	Hadlock 1
	BPD, AC, FL	Hadlock 2
	AC, FL	Hadlock 3
	BPD, TTD	Hansmann
	BPD, FTA, FL	Osaka U.
	BPD, AC	Shepard
	BPD, TTD, APTD, FL	Tokyo U.
Ratios	HC/AC	Campbell
	FL/AC	Hadlock
	FL/BPD	Hohler
	FL/HC	Hadlock
Amniotic Fluid Index	Q ¹ , Q ² , Q ³ , Q ⁴	Jeng
Growth Analysis Tables (See note 4)	BPD	Chitty Hadlock Jeanty
	HC	Chitty Hadlock Jeanty
	AC	Chitty Hadlock Jeanty
	FL	Chitty Hadlock Jeanty
	EFW	Hadlock Jeanty
	HC/AC	Campbell

Note 1: The Gestational Age is automatically calculated and displayed next to the OB measurement you selected. The average of the results is the AUA.

Note 2: The Estimated Fetal Weight calculation uses an equation that consists of one or more fetal biometry measurements. The author for the OB tables, which you choose in system setup, determines the measurements you must perform to obtain an EFW calculation. See “OB Calculations Authors” on page 40, if necessary.

Note 3: Individual selections for Hadlock’s EFW equations 1, 2, and 3 are not determined by the user. The selected equation is determined by the measurements that have been saved to the report with priority given to the order listed above.

Note 4: The Growth Analysis tables are used by the Report Graphs feature. Three growth curves are drawn using the table data for the selected growth parameter and published author. Growth tables are only available with a user-entered LMP or Estab. DD.

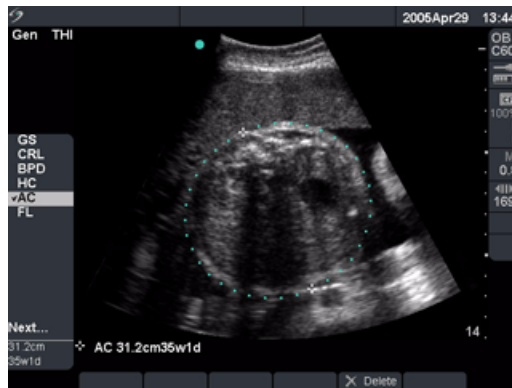

Figure 8 OB Measurement

Note: EFW is only calculated once appropriate measurements are completed. If any one of these parameters results in a EDD greater than what the OB tables provide, the EFW will not be displayed.

OB

- 1 Select **OB** exam type and select **LMP** or **Estab.DD** in the patient information form.
- 2 Select **Twins** if appropriate.
- 3 On a frozen 2D image, press the **Calcs** key.
- 4 From the calculations menu, select the desired measurement.
 - For twin calculations, select **Twin A** or **Twin B**, then select the desired measurement.
 - The caliper tool may change depending on the measurement selected, but, the position remains constant.
- 5 Perform the measurement.
- 6 Select **Save** from the on-screen menu or press the **Enter** key to save the measurement to the patient report.
 - For each 2D OB measurement (except AFI), the system stores up to three individual measurements and their average. If more than three measurements are made, the oldest measurement is deleted.
 - The average measurement and ultrasound age are displayed at the bottom of the calculation menu and a check mark is put in front of the measurement.
 - If desired, press the **Save** key to save the image with the measurements displayed.
- 7 Select the next measurement.
- 8 Repeat these steps until all measurements have been performed.

The following table lists the ratios available for OB Doppler calculations.

Table 11: OB Doppler Calculations

Measurement	Description	S/D	RI	PI*
MCA	Middle Cerebral Artery	X	X	X
Umb A	Umbilical Artery	X	X	X

*Calculation requires a trace.

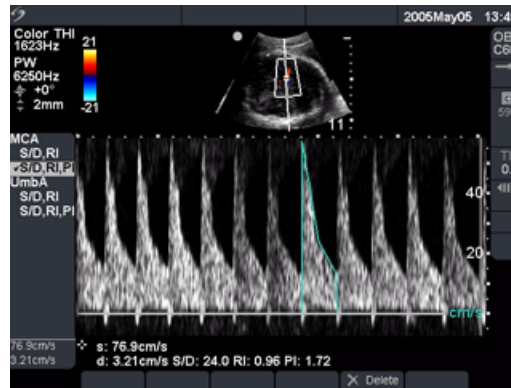

Figure 9 OB Doppler Calculation

OB Doppler

Note: The system does not provide an MCA/UmbA ratio from the PI (Pulsatility Index).

**MCA
(Middle Cerebral
Artery)**

- 1 Select **OB** exam type, and select **LMP** or **Estab.DD** in the patient information form.
- 2 On a frozen Doppler spectral trace, press the **Calcs** key.
- 3 From the calculations menu, select the desired measurement.
- 4 Perform the measurement.

**UmbA
(Umbilical Artery)****Caliper Function**

If S/D, RI is selected, the caliper function is activated.

- Position the first caliper at the peak systolic waveform. Press the **Select** key and position the second caliper at end diastole on the waveform.

OR

Manual Trace

If S/D, RI, PI is selected, the manual trace function is activated.

- Position the caliper at the beginning of the desired waveform and press the **Select** key. Use the **Touchpad** to trace the desired area.
- Complete the trace and select **Set** from the on-screen menu.

If calipers are not placed in the correct position, the calculation is not performed accurately.

- 5 Select **Save** from the on-screen menu, or press the **Enter** key to save the measurements to the patient report.
 - The results are displayed at the bottom of the calculation menu and a check mark is put in front of the measurement.
 - If desired, press the **Save** key to save the image with the measurements displayed.
 - Only one calculation (S/D, RI or S/D, RI, PI) can be saved.
- 6 Repeat these steps until all measurements are performed.

Vascular Calculations

WARNING: Verify that the patient information, date, and time settings are accurate.
Before starting a new calculation, start a new patient exam to delete the previous measurements. See [“New Patient”](#) on page 49.

Vascular Measurements

The following table shows the transducers and exam types that provide vascular measurements.

Table 12: Transducer and Exam Types for Vascular

Transducer	Exam Types
HFL38	Vascular
L25e	Vascular
L38e	Vascular
P10	Vascular
SLA	Vascular

Carotid vascular measurements may be performed and saved to the patient report. The specific measurements that can be stored to the patient report are provided in the following table. For definitions of acronyms, see [“Glossary”](#) on page 287.

Table 13: Carotid Vascular Measurements

Vascular Measurement	Systolic	Diastolic
PCCA	X	X
MCCA	X	X
DCCA	X	X
Bulb	X	X
PICA	X	X
MICA	X	X
DICA	X	X
PECA	X	X
MECA	X	X
DECA	X	X

Table 13: Carotid Vascular Measurements (Continued)

Vascular Measurement	Systolic	Diastolic
VArty	X	X

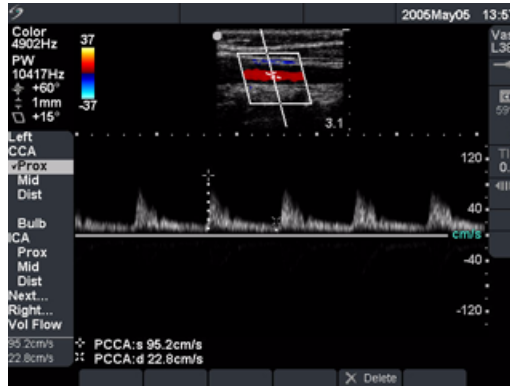

Figure 10 Vascular Measurement

Label Vascular Measurement

Note: After vascular measurements are performed, values used in the ICA/CCA ratio are selectable on the vascular report page.

- 1 On a frozen Doppler spectral trace, press the **Calcs** key.
- 2 From the calculations menu, select **Left** or **Right** then select the desired measurement.
- 3 Use the **Touchpad** to position the caliper at the peak systolic wave form.
- 4 Press the **Select** key.
A second caliper is displayed on the screen. The active caliper is highlighted green.
- 5 Use the **Touchpad** to position the second caliper at end diastole on the waveform.
- 6 Select **Save** from the on-screen menu, or press the **Enter** key to save the measurement to the patient report.
 - The saved measurement is displayed at the bottom of the calculation menu and a check mark is put in front of the measurement.
 - If desired, press the **Save** key to save the image with the measurements displayed.
- 7 Repeat these steps until all measurements have been performed.

IMT Calculations

WARNING: To ensure high quality images, all patient images must be obtained by qualified and trained individuals.

To avoid patient injury, IMT results should not be used as a sole diagnostic tool. All IMT results should be interpreted in conjunction with other clinical information or risk factors.

To avoid measurement errors, all measurements must be of the common carotid artery (CCA). This tool is not intended for measuring the bulb or the internal carotid artery (ICA).

Verify that the patient information, date, and time settings are accurate.

Before starting a new calculation, start a new patient exam to delete the previous measurements. See “[New Patient](#)” on page 49.

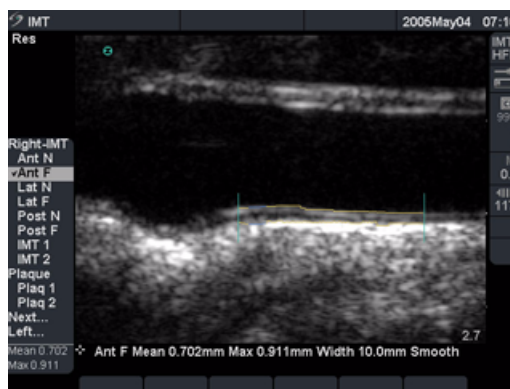

Figure 11 IMT

The following table shows the transducers and exam types that provide intima-media thickness (IMT) calculations.

Table 14: Transducer and Exam Types for IMT

Transducer	Exam Types
L25e	IMT
L38e	IMT
HFL38	IMT

2D IMT Calculations

The following table shows the available IMT labels. A maximum of eight labels are allowed for both Right and Left side calculations. The labels may be selected in system Setup within the IMT calculations page. In addition to the IMT labels, two distance plaque calculations are allowed.

Table 15: IMT Calculations for 2D Mode

Imaging Mode/Calculation	Label
2D/IMT	Ant N (Anterior Near Wall)
	Ant F (Anterior Far Wall)
	Lat N (Lateral Near Wall)
	Lat F (Lateral Far Wall)
	Post N (Posterior Near Wall)
	Post F (Posterior Far Wall)
	IMT 1
	IMT 2
	IMT 3
	IMT 4
	IMT 5
	IMT 6
	IMT 7
IMT 8	
2D/Plaque	Plaq 1
	Plaq2

IMT Automatic Calculation



- 1 On a frozen 2D image (1x or zoomed), press the **Calcs** key.
- 2 From the calculations menu, select the desired measurement.
- 3 Use the **Touchpad** to position the IMT tool over the area of interest until the tool displays results.
- 4 Select **Hide** from the on-screen menu to check results.
To save the measurement to the report, ensure the IMT trace is displayed.
- 5 Select **Save** from the on-screen menu, or press the **Enter** key to save the measurement to the patient report.



IMT Tool Adjustments

Note: The IMT tool may be adjusted for horizontal position and width.

Note: The arrow keys may be used to adjust the tool position.



1 Select **Move** from the on-screen menu to adjust the IMT tool position horizontally.

- The top key moves the tool several pixels to the right.
- The bottom key moves the tool several pixels to the left.



2 Select **Width** from the on-screen menu to adjust the IMT tool width.

- The top key increases the width by 1 mm.
 - The bottom key decreases the width by 1 mm.
-

IMT Tool Editing

Note: The IMT lines may be adjusted for vertical position and smoothing.

1 Select **Edit** from the on-screen menu.

2 Select **Smooth** from the on-screen menu to adjust the IMT line smoothing.



3 Select **Advent** from the on-screen menu to adjust the adventitia-media line.

- The top key moves the line upward on the screen.
- The bottom key moves the line downward.



4 Select **Lumen** from the on-screen menu to adjust the lumen-intima line.

- The top key moves the line upward on the screen.
- The bottom key moves the line downward.
- Each of the two IMT lines can be adjusted independently.

IMT Tool Trace 

Trace mode defines the IMT measurement solely from the user-defined location.

- 1 Select **Edit** from the on-screen menu.
 - 2 Select **Manual** from the on-screen menu.
 - 3 Select **Sketch** from the on-screen menu.
A single caliper is displayed on the screen and **Trace** shows on-screen next to the selected calculation.
 - 4 Position the caliper at the beginning of the desired adventitia-media boundary and press the **Select** key.
 - 5 Use the **Touchpad** to move the caliper to the next desired point.
 - 6 Continue marking points by pressing the **Select** key.
If an error is made select **Undo** from the on-screen menu or press the **Backspace** key to delete the previous position.
 - 7 Select **Set** from the on-screen menu to complete the first trace line.
 - 8 Repeat steps 4, 5, and 6 for the lumen-intima boundary.
 - 9 Select **Set** from the on-screen menu to complete the second trace line and display results.
 - 10 Select **Save** from the on-screen menu, or press the **Enter** key to save the measurement to the patient report.
-

IMT Tool Sketch 

Sketch mode locates the IMT measurement between two user-defined sketch lines that can be adjusted manually.

- 1 Select **Edit** from the on-screen menu.
 - 2 Select **Manual** from the on-screen menu.
A single caliper is displayed on the screen and **Sketch** shows on-screen next to the selected calculation.
 - 3 Position the caliper at the beginning of the desired adventitia-media boundary and press the **Select** key.
 - 4 Use the **Touchpad** to move the caliper to the next desired point.
 - 5 Continue marking points by pressing the **Select** key.
If an error is made select **Undo** from the on-screen menu or press the **Backspace** key to delete the previous position.
 - 6 Select **Set** from the on-screen menu to complete the first trace line.
 - 7 Repeat steps 3, 4, and 5 for the lumen-intima boundary.
 - 8 Select **Set** from the on-screen menu to complete the second trace line and display results.
If necessary, adjust the measurement by selecting **Width** or **Edit** from the on-screen menu. If you select **Edit**, you can select **Smooth**, **Lumen**, or **Adventitia** from the on-screen menu to make additional measurement edits.
 - 9 Select **Save** from the on-screen menu, or press the **Enter** key to save the measurement to the patient report.
-

Transcranial Doppler Calculations (TCD)

WARNING: To avoid injury to the patient, use only an orbital exam type (Orb) when performing imaging through the eye.

Verify that the patient information, date, and time settings are accurate.

Before starting a new calculation, start a new patient exam to delete the previous measurements. See [“New Patient”](#) on page 49.

The following table shows the transducer and exam type that provides TCD calculations.

Table 16: Transducer and Exam Types for Transcranial Doppler

Transducer	Exam Types
P17	Transcranial (TCD), Orbital (Orb)

The following table shows the measurements required to complete the TCD calculation. For definitions of acronyms, see [“Glossary”](#) on page 287.

Table 17: Transcranial Calculations in Doppler

Anatomy/Condition	Measurement	Calculation Result
TT (Right and Left)	MCA	TAP
	Prox	PSV
	Mid	EDV
	Dist	PI
	Bifur	RI
	ACA	S/D
	ACoA	Gate Size
	TICA	
	PCAp1	
	PCAp2	
TO	Ophthalmic Artery (OA)	TAP
		PSV
	Siphon	EDV
		PI
		RI
	S/D	
	Gate Size	

Table 17: Transcranial Calculations in Doppler (Continued)

Anatomy/Condition	Measurement	Calculation Result
SM	Extracranial Internal Carotid Artery (ECICA)	TAP PSV EDV PI RI S/D Gate Size
FM (Right and Left)	Vertebral Artery (VA)	TAP PSV EDV PI RI S/D Gate Size
BA (Right and Left)	Dist Mid Prox	TAP PSV EDV PI RI S/D Gate Size
AL (Right and Left)	Extracranial Vertebral Artery (ECVA)	TAP PSV EDV PI RI S/D Gate Size

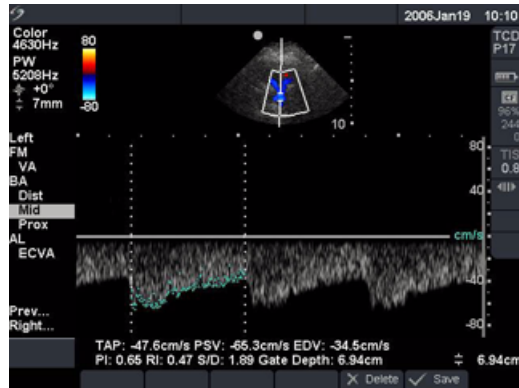

Figure 12 Transcranial Doppler (TCD)

-
- Transcranial Doppler (TCD)**
- 1 On a frozen Doppler spectral trace, press the **Calcs** key.
 - 2 From the calculations menu, select **Left** or **Right** then select the desired measurement.
 - 3 Use the **Touchpad** to position the caliper.
 - 4 Complete the trace and select **Set** from the on-screen menu.
 - 5 Select **Save** from the on-screen menu or press the **Enter** key to save the measurement to the patient report.
 - 6 Select the next measurement.
 - 7 Repeat these steps until all measurements have been performed.
- For information on using the automatic trace tool, see [“Automatic Trace”](#) on page 87.

WARNING: To avoid injury to the patient, use only an orbital exam type (Orb) when performing imaging through the eye. The FDA has established lower acoustic energy limits for ophthalmic use. The system will not exceed these limits only if the Orb exam type is selected.

-
- Transorbital (TO)**
- 1 Select the **Orbital (Orb)** exam type.
 - 2 On a frozen Doppler spectral trace, press the **Calcs** key.
 - 3 From the calculations menu, select **Left** or **Right** then locate **TO** and select **OA** or **Siphon**.
 - 4 Use the **Touchpad** to position the caliper.
 - 5 Complete the trace and select **Set** from the on-screen menu.
 - 6 Select **Save** from the on-screen menu or press the **Enter** key to save the measurement to the patient report.
 - 7 Select the next measurement.
- For information on using the automatic trace tool, see [“Automatic Trace”](#) on page 87.

Cardiac Calculations

WARNING: Verify that the patient information, date, and time settings are accurate. Before starting a new calculation, start a new patient exam to delete the previous measurements. See [“New Patient”](#) on page 49.

References for measurements and calculations are in [Chapter 7, “References.”](#) The following table shows the transducers and exam types that provide cardiac calculations. See the *TEE User Guide* and *TEE Care Instructions* for information on using the TEE transducer.

Table 18: Transducer and Exam Types for Cardiac

Transducer	Exam Types
D2	Cardiac
P17	Cardiac
TEE	Cardiac
P10	Cardiac

2D and M Mode Cardiac Calculations

The following table shows the measurements required to complete the desired cardiac calculation. The cardiac measurements are done in 2D and M Mode. For definitions of acronyms, see [“Glossary” on page 287](#).

Table 19: Cardiac Calculations in 2D

Description	Cardiac Measurement	Calculation Result
LV	RVWd	CO
	RVDd	EF
	IVSd	SV
	LVDd	LVESV
	LVPWd	LVEDV
	RVWs	IVSFT
	RVDs	LVPWFT
	IVSs	LVDFS
	LVDs	CI
	LVPWs	SI
	HR needed for CO & CI	
Ao	Ao	Ao LA/Ao
	LA	LA LA/Ao
	AAo	AAo
	LVOT D	LVOT D LVOT area
Area	AV	AV Area
	MV	MV Area
LV Vol	A4Cd	LV Vol
	A4Cs	LV Area
	A2Cd	EF
	A2Cs	CO
	(Biplane)	SV
		CI SI
LV mass	Epi	LV Mass
	Endo	Epi Area
	Apical	Endo Area
		D Apical

Table 19: Cardiac Calculations in 2D (Continued)

Description	Cardiac Measurement	Calculation Result
PISA	Ann D Radius in Color MR/VTI in Doppler MV/VTI in Doppler	PISA Area ERO MV Rate Regurgitant Volume Regurgitant Fraction
Qp/Qs	LVOT D RVOT D LVOT VTI in Doppler RVOT VTI in Doppler	D VTI VMax PGmax Vmean PGmean SV Qp/Qs

Table 20: Cardiac Calculations in M Mode

Description	Cardiac Measurement	Calculation Result
LV	RWd	CO
	RVDd	EF
	IVSd	SV
	LVDd	LVESV
	LVPWd	LVEDV
	RW _s	IVSFT
	RVD _s	LVPWFT
	IVS _s	LVDFS
	LVD _s	CI
	LVPW _s	SI
	HR in M Mode or Doppler	LV Mass
Ao	Ao LA/Ao	
LA	LA LA/Ao	
ACS	ACS	
LVET	LVET	
EF:SLOPE	EF:SLOPE	
EPSS	EPSS	

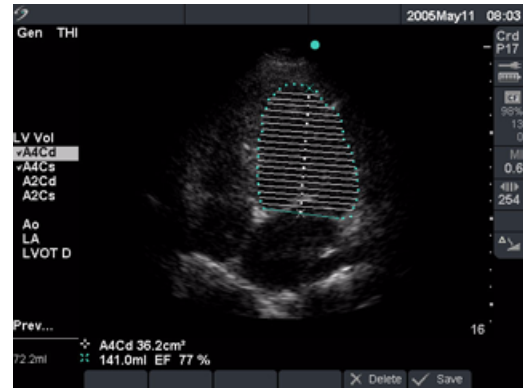
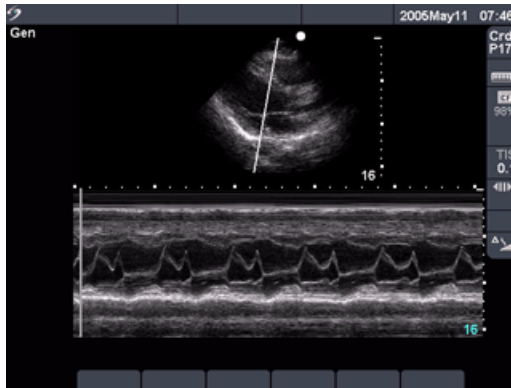

Figure 13 Cardiac M Mode and LV Volume

LvD and LVs (2D and M Mode)

- 1 On a frozen 2D image or M Mode trace, press the **Calcs** key.
- 2 Select the measurement.
- 3 Position the active caliper at the starting point.
The active caliper is highlighted green.
- 4 Press the **Select** key to highlight and activate the second caliper.
- 5 Position the second caliper.
- 6 Press the **Select** key to advance to the next measurement.
- 7 Repeat until all measurements in that calculation group are completed.
- 8 Select **Save** from the on-screen menu, or press the **Enter** key to save the measurements to the patient report.
 - The saved measurements are displayed at the bottom of the calculation menu and a check mark is put in front of the measurement.
 - If desired, press the **Save** key to save the image with the measurements displayed.

Ao, LA, AAO, and LVOT D

- 1 On a frozen 2D image or M Mode trace, press the **Calcs** key.
- 2 From the calculations menu, select the desired measurement.
- 3 Perform the measurement.
- 4 Select **Save** from the on-screen menu, or press the **Enter** key to save the measurements to the patient report.
 - The saved measurement is displayed at the bottom of the calculation menu and a check mark is put in front of the measurement.
 - If desired, press the **Save** key to save the image with the measurements displayed.

**LV Volume
(Simpson's Rule)**

- 1 On a frozen 2D image, press the **Calcs** key.
 - 2 From the calculations menu, select the desired view and phase.
 - 3 Position the caliper at the medial mitral annulus and press the **Select** key to start the tracing function.
 - 4 Use the **Touchpad** to trace the left ventricular (LV) cavity.
If an error is made, select **Undo** from the on-screen menu to delete the previous position.
 - 5 Complete the trace and select **Set** from the on-screen menu.
 - 6 Select **Save** from the on-screen menu, or press the **Enter** key to save the measurement to the patient report.
 - The saved measurement is displayed at the bottom of the calculation menu and a check mark is put in front of the measurement.
 - If desired, press the **Save** key to save the image with the measurements displayed.
 - 7 Select the next measurement.
 - 8 Repeat these steps until all measurements have been performed.
-

MV/AV Area

- 1 On a frozen 2D image, press the **Calcs** key.
- 2 From the calculations menu, locate **Area** then select **MV** or **AV**.
- 3 Position the caliper at the trace start point and press the **Select** key to start the tracing function.
- 4 Use the **Touchpad** to trace the desired area.
If an error is made, select **Undo** from the on-screen menu to delete the previous position.
- 5 Complete the trace and select **Set** from the on-screen menu.
- 6 Select **Save** from the on-screen menu, or press the **Enter** key to save the measurement to the patient report.
 - The saved measurement is displayed at the bottom of the calculation menu and a check mark is put in front of the measurement.
 - If desired, press the **Save** key to save the image with the measurements displayed.

LV Mass

- 1 On a frozen 2D image, press the **Calcs** key.
- 2 From the calculations menu, locate **LV Mass** then select **EPI**.
- 3 Position the caliper at the trace start point and press the **Select** key to start the tracing function.
- 4 Use the **Touchpad** to trace the desired area.
If an error is made, select Undo from the on-screen menu to delete the previous position.
- 5 Complete the trace and select **Set** from the on-screen menu.
- 6 Select **Save** from the on-screen menu, or press the **Enter** key to save the measurement to the patient report.
 - The saved measurement is displayed at the bottom of the calculation menu and a check mark is put in front of the measurement.
 - If desired, press the **Save** key to save the image with the measurements displayed.
- 7 Select **Endo**.
- 8 Position the caliper at the trace start point and press the **Select** key to start the tracing function.
- 9 Complete the trace and select **Set** from the on-screen menu.
- 10 Select **Save** from the on-screen menu to save the measurement to the patient report.
- 11 Select **Apical**.
- 12 Measure the ventricular length.
- 13 Select **Save** from the on-screen menu to save the measurement to the patient report.

Doppler Cardiac Calculations

- Remove Trace** On a trace performed in Doppler mode, if an error is made, do one of the following to remove the caliper points:
- Use the **Touchpad** to backtrack caliper over caliper points.
 - Press the **Backspace** key.
 - Select **Undo** from the on-screen menu.

The following table shows the measurements required to complete the desired cardiac calculation. The cardiac measurements are done in PW Doppler and CW Doppler mode. For definitions of acronyms, see [“Glossary” on page 287](#).

Table 21: Cardiac Calculations in Doppler

Description	Cardiac Measurement	Calculation Result
MV	E	E
	A	E PG A A PG E:A
	PHT (deceleration time)	PHT MVA Decel time
	VTI	VTI Vmax PGmax Vmean PGmean
	IVRT	IVRT
dP:dT	100 cm/sec 300 cm/sec	dP:dT
PISA	Radius in Color MR/VTI Ann D in 2D MV/VTI	PISA Area ERO MV Rate Regurgitant Volume Regurgitant Fraction

Table 21: Cardiac Calculations in Doppler (Continued)

Description	Cardiac Measurement	Calculation Result
AV	Vmax	Vmax PGmax
	VTI	VTI Vmax PGmax Vmean PGmean
	LVOT D in 2D VTI or Vmax from LVOT VTI or Vmax from AV	AVA
	VTI LVOT D in 2D	SV
	VTI HR LVOT D in 2D	CO
LVOT	Vmax	Vmax PGmax
	VTI	VTI Vmax PGmax Vmean PGmean
AI	PHT (slope)	AI PHT AI slope
TV	TRmax	TRmax PGmax
	RA pressure	RVSP
PV	Vmax	Vmax PGmax
	VTI	VTI Vmax PGmax Vmean PGmean

Table 21: Cardiac Calculations in Doppler (Continued)

Description	Cardiac Measurement	Calculation Result
Qp/Qs	LVOT D in 2D	D
	RVOT D in 2D	VTI
	LVOT VTI	VMax
	RVOT VTI	SV
		Qp/Qs
TDI	Wall e and a	Vmax
	Wall e and a	E/e' ratio
	Wall e and a	
	Wall e and a	

Doppler Cardiac Calculations

- E, A, VMax, and TRmax, e' and a'**
- 1 On a frozen Doppler spectral trace, press the **Calcs** key.
 - 2 From the calculations menu, select **MV, TV, or TDI** then select the desired measurement.
 - 3 Perform the measurement.
 - 4 Select **Save** from the on-screen menu, or press the **Enter** key to save the measurement to the patient report.
 - For each cardiac measurement, the system stores up to five individual measurements and their average. If more than five measurements are made, the most recently taken measurement replaces the fifth one.
 - If a saved measurement is deleted from the report, the next measurement taken replaces the deleted one in the report.
 - The most recently saved measurement is displayed at the bottom of the calculation menu and a check mark is put in front of the measurement.
 - If desired, press the **Save** key to save the image with the measurements displayed.
 - 5 Select the next measurement.
 - 6 Repeat these steps until all measurements have been performed.
 - 7 Select **Save** from the on-screen menu to save the measurement to the patient report.

**Velocity Time
Integral (VTI)**

Note: This calculation computes other result in addition to VTI.s. See [Table 21](#).

- 1 On a frozen Doppler spectral trace, press the **Calcs** key.
- 2 From the calculations menu, select **MV, AV, PV,** or **LVOT** then select **VTI**.
- 3 Position the caliper at the start of the wave form.
- 4 Press the **Select** key to start the trace.
- 5 Trace the wave form and select **Set** from the on-screen menu.
If an error is made, do one of the following to remove the caliper points:
 - Use the **Touchpad** to backtrack caliper over caliper points.
 - Press **Backspace** key.
 - Select **Undo** from the on-screen menu.
- 6 Select **Save** from the on-screen menu, or press the **Enter** key to save the measurement to the patient report.
 - The saved measurement is displayed at the bottom of the calculation menu and a check mark is put in front of the measurement.
 - If desired, press the **Save** key to save the image with the measurements displayed.

For information on using the automatic trace tool, see [“Automatic Trace”](#) on page 87.

**Right Ventricular
Systolic Pressure
(RVSP)**

- 1 On a frozen Doppler spectral trace, press the **Calcs** key.
- 2 From the calculations menu, select **TV** then select **TRmax**.
- 3 Perform the measurement.
- 4 Select **Save** from the on-screen menu, or press the **Enter** key to save the measurement to the patient report.
 - The saved measurement is displayed at the bottom of the calculation menu and a check mark is put in front of the measurement.
 - If desired, press the **Save** key to save the image with the measurements displayed.
- 5 To adjust the RA pressure, press the **Report** key to open the report.
- 6 Select the appropriate number from the **RA** list.
If you change the RA from the default number 5, it affects the RVSP calculation in the report.

Pressure Half Time (PHT) in MV or AV

Note: On cardiac exams only, PHT shows on the on-screen menu. It can be selected there instead of via the calculations menu.

- 1 On a frozen Doppler spectral trace, press the **Calcs** key.
- 2 From the calculations menu, select **MV** or **AV** then select **PHT**.
- 3 Position the first caliper at the peak and press the **Select** key.
A second caliper is displayed.
- 4 Position the second caliper:
 - In MV, position the caliper along the EF slope.
 - In AV, position the caliper at end diastole.
- 5 Select **Save** from the on-screen menu, or press the **Enter** key to save the measurement to the patient report.
 - The saved measurement is displayed at the bottom of the calculation menu and a check mark is put in front of the measurement.
 - If desired, press the **Save** key to save the image with the measurements displayed.

Proximal Isovelocity Surface Area (PISA)

Note: This calculation requires a measurement taken in 2D, a measurement taken in color, and two measurements taken in spectral Doppler. After all measurements are completed and saved, the result is displayed in the patient report.

2D measurement from Ann D

- 1 On a frozen 2D image, press the **Calcs** key.
- 2 From the calculations menu, locate **PISA**, then select **Ann D**.
- 3 Perform the measurement.
- 4 Select **Save** from the on-screen menu, or press the **Enter** key to save the measurement to the patient report.
 - The saved measurement is displayed at the bottom of the calculation menu and a check mark is put in front of the measurement.
 - If desired, press the **Save** key to save the image with the measurements displayed.

Color measurement from Radius

- 1 On a frozen Color image, press the **Calcs** key.
- 2 From the calculations menu, select **Radius**.
- 3 Perform the measurement.
- 4 Select **Save** from the on-screen menu to save the measurement to the patient report.

PISA (continued)***Doppler measurement from MR VTI and MV VTI***

- 1 On a frozen Doppler spectral trace, press the **Calcs** key.
 - 2 From the calculations menu, select **PISA** then select **MRVTI**.
 - 3 Position the caliper at the start of the waveform and press the **Select** key to start the trace.
 - 4 Trace the waveform and select **Set** from the on-screen menu.
 - 5 Select **Save** from the on-screen menu, or press the **Enter** key to save the measurement to the patient report.
 - 6 Select **MVVTI**.
 - 7 Position the caliper at the start of the waveform and press the **Select** key to start the trace.
 - 8 Trace the waveform and select **Set** from the on-screen menu.
 - 9 Select **Save** from the on-screen menu to save the measurement to the patient report.
- For information on using the automatic trace tool, see [“Automatic Trace”](#) on page 87.

**Isovolumic
Relaxation Time
(IVRT)**

- 1 On a frozen Doppler spectral trace, press the **Calcs** key.
- 2 From the calculations menu, select **MV** then select **IVRT**.
A vertical caliper is displayed.
- 3 Use the **Touchpad** to position the caliper at the aortic valve closure.
- 4 Press the **Select** key.
A second vertical caliper is displayed.
- 5 Use the **Touchpad** to position the second caliper at onset of mitral inflow.
- 6 Select **Save** from the on-screen menu, or press the **Enter** key to save the measurement to the patient report.
 - The saved measurement is displayed at the bottom of the calculation menu and a check mark is put in front of the measurement.
 - If desired, press the **Save** key to save the image with the measurements displayed.

**Delta Pressure:
Delta Time (dP:dT)**

Note: To perform the dP:dT measurements, the CW Doppler scale must include velocities of 300 cm/s or greater on the negative side of the baseline.

- 1 On a frozen CW Doppler spectral trace, press the **Calcs** key.
- 2 From the calculations menu, select **MV** then select **dP:dT**.
A horizontal dotted line with an active caliper is displayed at 100 cm/s.
- 3 Position the first caliper along the wave form at 100 cm/s.
- 4 Press the **Select** key.
A second horizontal dotted line with an active caliper is displayed at 300 cm/s.
- 5 Position the second caliper along the wave form at 300 cm/s.
- 6 Select **Save** from the on-screen menu, or press the **Enter** key to save the measurement to the patient report.
 - The saved measurement is displayed at the bottom of the calculation menu and a check mark is put in front of the measurement.
 - If desired, press the **Save** key to save the image with the measurements displayed.

**Aortic Valve Area
(AVA)**

Note: This calculation requires a measurement taken in 2D and two measurements taken in Doppler. After the three measurements are completed and saved, the result is displayed in the patient report.

2D measurement from LVOT

- 1 On a frozen 2D image, press the **Calcs** key.
- 2 From the calculations menu, select **LVOT D**.
- 3 Perform the measurement.
- 4 Select **Save** from the on-screen menu, or press the **Enter** key to save the measurement to the patient report.
 - The saved measurement is displayed at the bottom of the calculation menu and a check mark is put in front of the measurement.
 - If desired, press the **Save** key to save the image with the measurements displayed.

**Aortic Valve Area
(AVA) (continued)**

Doppler measurement from LVOT

- 1 On a frozen Doppler spectral trace, press the **Calcs** key.
- 2 From the calculations menu, select **AV**.
- 3 Locate **LVOT**, then select **Vmax** or **VTI**.
- 4 Perform the measurement. See “E, A, VMax, and TRmax, e’ and a” on page 126 or “Velocity Time Integral (VTI)” on page 127.
- 5 Select **Save** from the on-screen menu, or press the **Enter** key to save the measurement to the patient report.
 - The saved measurement is displayed at the bottom of the calculation menu and a check mark is put in front of the measurement.
 - If desired, press the **Save** key to save the image with the measurements displayed.

Aortic Valve Area (AVA) (continued)

Doppler measurement from aorta

- 1 On a frozen Doppler spectral trace, press the **Calcs** key.
- 2 From the calculations menu, select **AV** then select **VTI** or **Vmax**.
- 3 Perform the measurement. See “E, A, VMax, and TRmax, e’ and a” on page 126 or “Velocity Time Integral (VTI)” on page 127.
- 4 Select **Save** from the on-screen menu, or press the **Enter** key to save the measurement to the patient report.
 - The saved measurement is displayed at the bottom of the calculation menu and a check mark is put in front of the measurement.
 - If desired, press the **Save** key to save the image with the measurements displayed.

Qp/Qs

Note: This calculation requires two measurements taken in 2D and two measurements taken in Doppler. After the measurements are completed and saved, the result is displayed in the patient report.

2D measurement from LVOT D and RVOT D

- 1 On a frozen 2D image, press the **Calcs** key.
- 2 From the calculations menu, locate **Qp/Qs** then select **LVOT D**.
- 3 Perform the measurement.
- 4 Select **Save** from the on-screen menu or press the **Enter** key to save the measurement to the patient report.
The saved measurement is displayed at the bottom of the calculation menu and a check mark is put in front of the measurement.
- 5 Select **RVOT D**.
- 6 Perform the measurement.
- 7 Select **Save** from the on-screen menu to save the measurement to the patient report.

Qp/Qs (continued)

Doppler measurement from LVOT VTI and RVOT VTI

- 1 On a frozen Doppler spectral trace, press the **Calcs** key.
- 2 From the calculations menu, select **Qp/Qs** then select **LVOT VTI**.
- 3 Trace the waveform and select the **Set** key from the on-screen menu.
- 4 Select **Save** from the on-screen menu or press the **Enter** key to save the measurement to the patient report.
- 5 Select **RVOT VTI**.
- 6 Trace the waveform and select the **Set** key from the on-screen menu.
- 7 Select **Save** from the on-screen menu to save the measurement to the patient report.
For information on using the automatic trace tool, see “Automatic Trace” on page 87.

Stroke Volume (SV) *Note: This calculation requires a measurement taken in 2D and one measurement taken in Doppler. After the measurements are completed and saved, the result is displayed in the patient report.*

2D measurement from LVOT

- 1 On a frozen 2D image, press the **Calcs** key.
- 2 From the calculations menu, select **LVOT D**.
- 3 Perform the measurement.
- 4 Select **Save** from the on-screen menu, or press the **Enter** key to save the measurement to the patient report.
 - The saved measurement is displayed at the bottom of the calculation menu and a check mark is put in front of the measurement.
 - If desired, press the **Save** key to save the image with the measurements displayed.

Doppler measurement from aorta

- 1 On a frozen Doppler spectral trace, press the **Calcs** key.
- 2 From the calculations menu, select **AV** then select **VTI**.
See “[Velocity Time Integral \(VTI\)](#)” on page 127.
- 3 Perform the measurement.
- 4 Select **Set** from the on-screen menu.
- 5 Select **Save** from the on-screen menu, or press the **Enter** key to save the measurement to the patient report.
 - The saved measurement is displayed at the bottom of the calculation menu and a check mark is put in front of the measurement.
 - If desired, press the **Save** key to save the image with the measurements displayed.

For information on using the automatic trace tool, see “[Automatic Trace](#)” on page 87.

Stroke Index (SI) *Note: This calculation requires a measurement taken in 2D and a measurement taken in Doppler. It also requires the inclusion of the Body Surface Area (BSA). After the measurements are completed and saved, the result is displayed in the patient report.*

- 1 Complete patient height and weight on the Patient Information page. The BSA is calculated automatically.
- 2 Perform the calculation for Stroke Volume (SV).
See “[Stroke Volume \(SV\)](#)” on page 132.

Heart Rate (HR)

Note: Heart Rate is available in all cardiac packages. The Heart Rate is not calculated using the ECG trace.

- 1 On a frozen Doppler spectral trace, press the **Calcs** key.
- 2 From the calculations menu, select **HR**.
A vertical caliper is displayed on the screen.
- 3 Use the **Touchpad** to position the first vertical caliper at the peak of the heart beat.
- 4 Press the **Select** key.
A second vertical caliper is displayed on the screen. The active caliper is highlighted green.
- 5 Use the **Touchpad** to position the second vertical caliper at the peak of the next heart beat.
- 6 Select **Save** from the on-screen menu to save the heart rate measurement to the patient report.
 - This overwrites the previous heart rate value entered under exam/patient information.
 - If desired, press the **Save** key to save the image with the measurements displayed.

Cardiac Output (CO)

Note: This calculation requires a stroke volume and a heart rate. After the measurements are completed and saved, the result is displayed in the patient report.

- 1 Perform the calculation for SV.
See "[Stroke Volume \(SV\)](#)" on page 132.
- 2 Perform the calculation for HR.
See "[Heart Rate \(HR\)](#)" on page 133.

Cardiac Index (CI)

Note: This calculation requires a stroke volume, a heart rate, and body surface area (BSA).

- 1 Complete patient height and weight in the Patient Information page. The BSA is calculated automatically.
- 2 Perform the Calculation for Cardiac Output (CO).
See "[Cardiac Output \(CO\)](#)" on page 133.

Tissue Doppler Imaging (TDI)

- 1 Ensure TDI is turned on. See [“Tissue Doppler Imaging \(TDI\)”](#) on page 66.
- 2 On a frozen Doppler spectral trace, press the **Calcs** key.
- 3 From the calculations menu, select **TDI** then select the desired measurement.
- 4 Perform the measurement.
- 5 Select **Save** from the on-screen menu, or press the **Enter** key to save the measurement to the patient report.
 - The saved measurement is displayed at the bottom of the calculation menu and a check mark is put in front of the measurement.
 - If desired, press the **Save** key to save the image with the measurements displayed.
- 6 Perform the next measurement.
- 7 Repeat these steps until all measurements are performed.

Patient Report

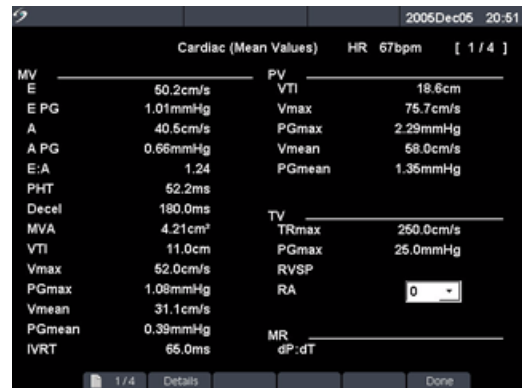

Figure 14 Vascular and Cardiac Patient Reports

Patient Reports

- 1 Press the **Report** key.
 - The pound symbol (###) is displayed on the patient report when an entry is out of range, for example, too large or small.
 - The value for a calculation is displayed only when the calculation has been performed.
 - Calculation values that are out of range are not included in derived calculations (for example, mean).
- 2 Select **1/x** from the on-screen menu to view additional pages of the patient report.
 - The last page of the patient report contains patient information.
 - In the OB report pages, a signature space is available for signing printed reports.
- 3 Press the **Save** key to save the current page of the patient report.
- 4 Select **Done** from the on-screen menu to exit patient report and return to the previous imaging state.

Vascular Report



- 1 At the end of a vascular exam, press the **Report** key.
- 2 Select **1/x** from the on-screen menu to view additional pages of the patient report.
- 3 Select **Details** or **Summary** from the on-screen menu to view report information in detail or summary form. The mean of the detail entries is used in the summary report.
- 4 To delete a measurement, go to the **Details** page, use the **Touchpad** to select the desired measurement.
 - The selected measurement is highlighted green.
 - Measurements can only be deleted from the Details page.
- 5 Select **Delete** from the on-screen menu.
 - Deleting some measurements also deletes related measurements.
 - When a measurement is deleted, it is no longer included in the summary information.
- 6 In the **Ratio** list, select the desired measurements for the ICA/CCA ratio for both the right and left sides.

Cardiac Report



- 1 At the end of a cardiac exam, press the **Report** key.
- 2 Select **1/x** from the on-screen menu to view additional pages of the patient report.
- 3 Select **Details** or **Summary** from the on-screen menu to view report information in detail or summary form. The mean of the detail entries is used in the summary report.
- 4 To delete a measurement, go to the **Details** page, use the **Touchpad** to select the desired measurement.
 - The selected measurement is highlighted green.
 - Measurements can only be deleted from the Details page.
- 5 Select **Delete** from the on-screen menu.
 - Deleting some measurements also deletes related measurements.
 - When a measurement is deleted, it is no longer included in the summary information.

Transcranial Report		<ol style="list-style-type: none"> 1 At the end of a transcranial Doppler exam, press the Report key. 2 Select Next Page (1/x) from the on-screen menu to view additional pages of the patient report. 3 Select Details or Summary from the on-screen menu to view report information in detail or summary form. The maximum values for the TAP calculation are displayed on the summary page. 4 To delete a measurement, go to the Details page, use the Touchpad to select the desired TAP measurement. The selected measurement is highlighted green. 5 Select Delete from the on-screen menu. <ul style="list-style-type: none"> • Deleting a TAP measurement deletes the entire row of measurements. • When a measurement is deleted, it is no longer included in the summary information.
OB Twins Report (Individual)		<ol style="list-style-type: none"> 1 At the end of an OB exam, press the Report key. 2 Select Twin A/B from the on-screen menu to view individual twin reports.
OB Twins Report (Combined)		<ol style="list-style-type: none"> 1 At the end of an OB exam, press the Report key. 2 Select Compare from the on-screen menu to view both twins in a single report.
Delete OB Measurement		<ol style="list-style-type: none"> 1 At the end of an OB exam, press the Report key. 2 Use the Touchpad to select the desired OB measurement. The selected measurement is highlighted green. 3 Select Delete from the on-screen menu. To delete all measurements, select the measurement label and press the Select key then select Delete from the on-screen menu.
Send Report		<ol style="list-style-type: none"> 1 Ensure the printer is configured for serial port data export. See "Connectivity" on page 33. 2 Select Send Rep. from the on-screen menu. <ul style="list-style-type: none"> • Data is sent to the computer as a text file. • This function can be used for all reports.

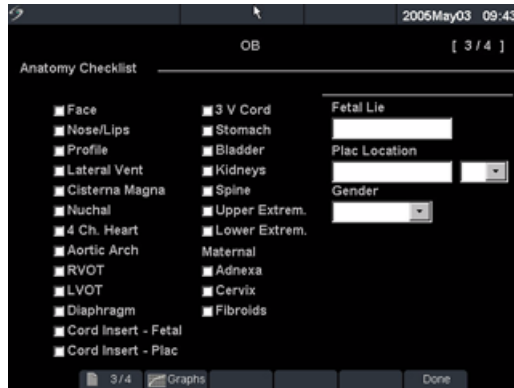

Figure 15 Anatomy Demonstrated

-
- | | |
|-----------------------------|---|
| Anatomy Demonstrated | <ol style="list-style-type: none"> 1 At the end of an OB exam, press the Report key. 2 On the page for Anatomy Demonstrated, select the check boxes to document reviewed anatomy.
Use the Tab key to move between fields and the Spacebar to check and uncheck items from the checklist. |
|-----------------------------|---|
-
- | | |
|----------------------------|--|
| Biophysical Profile | <ol style="list-style-type: none"> 1 At the end of an OB exam, press the Report key. 2 On page 2 of the report, select values for the biophysical profile (BPP) (0, 1, 2).
The total score is calculated when values are entered. NST (non-stress test) is optional. |
|----------------------------|--|

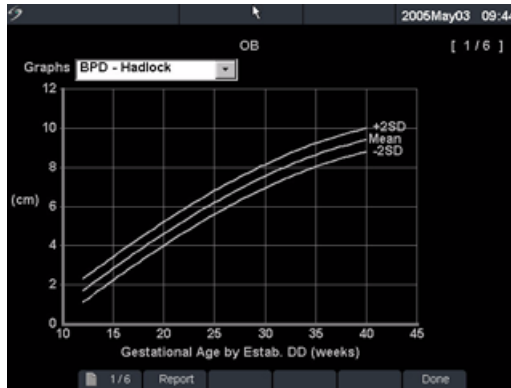

Figure 16 OB Graphs

OB Graphs

Note: OB Graphs may only be viewed when LMP or Estab. DD is entered in the patient information screen.

- 1 At the end of an OB exam, press the **Report** key.
- 2 Select **Graphs** from the on-screen menu.
- 3 In the **Graphs** list, select the desired measurement/author.



The graph for the selected measurement is displayed. If desired, select another measurement/author or select **1/x** from the on-screen menu. If desired, press the **Save** key to save the current graph page.

- 4 Select **Report** from the on-screen menu to return to the previous report page or **Done** to return to live imaging. For twins, both measurement sets are plotted on the same graph.



Figure 17 EMED Worksheet

**EMED
Worksheets**



This feature is optional.

- 1 At the end of an exam, press the **Report** key.
- 2 Select **EMED** from the on-screen menu.
- 3 Select the desired worksheet: **AAA**, **FAST**, **Gallbladder (GB)**, **Kidney**.

Chapter 5: Connectivity and Configuration

SiteLink Image Manager and DICOM are easy and effective methods of transferring data and images when using the ultrasound system. This chapter contains instructions for configuring SiteLink or configuring and using DICOM.

- SiteLink is an optional feature that works with the system software on MicroMaxx to transfer saved images and video clips from the system to a personal computer (PC). For more information, see the *SiteLink Image Manager User Guide*.
- DICOM is an optional data-transfer feature that allows the system to connect over a local area network (LAN) to PACS archivers, to film printers, and to worklist servers.

System Connectivity Setup

-
- | | | |
|----------------------|---|--|
| Set Up System | 1 | Press the Setup key, then select Connectivity . |
| Connectivity | 2 | In the Transfer Mode list, select DICOM or SiteLink .
If the transfer mode is changed, a dialog box is displayed to restart the system. |
| | 3 | Select DICOM Setup or SiteLink Setup .
The system is now ready to configure SiteLink or DICOM. See “Configuring SiteLink for Ethernet” on page 142 or “Configure DICOM for Ethernet” on page 148. |

System Configuration for SiteLink

Note: SiteLink is an optional feature.

The system provides configuration pages for setting up SiteLink network configuration. SiteLink configuration pages typically are set up by network administrators. If transferring images using USB or CompactFlash® reader, see the *SiteLink Image Manager User Guide* for information.

- Perform the [“System Connectivity Setup”](#) on page 141 to establish SiteLink as the transfer mode before configuring the ultrasound system.
- If your ultrasound system is wireless compatible, see [“Configuring SiteLink for Wireless”](#) on page 143.
- The setting for SiteLink Image Manager and system configurations must correspond. See the *SiteLink Image Manager User Guide*.

Configuring SiteLink for Ethernet

- Connect to LAN** 1 Connect the Ethernet cable to the Ethernet interface cable, then connect to the Ethernet connection on the mini-dock or docking system. See the applicable SonoSite accessory user guide.
- 2 With the system on, check the LAN link light (green LED) next to the Ethernet connector to verify physical connection to LAN.

The screenshot displays the SiteLink Configuration window. At the top right, the date and time are shown as 2005Sep21 22:05. The main area is divided into two sections: a table for aliases and a 'Location' configuration section.

Alias	IP Address	Subnet Mask	Default Gateway
Not connected			
Alias_01		255.255.0.0	

Location

Host Name: MicroMAXX

Alias: Alias_01

Wireless

IP Address: 172 . 20 . 20 . 20

Subnet Mask: 255 . 255 . 0 . 0

Default Gateway: [] . [] . [] . []

Alternate Gateway: [] . [] . [] . []

Network Speed: Auto Negotiate

Buttons: New, Delete, Symbols..., Cancel, Save

Bottom bar: Import, Export, Done

Figure 1 SiteLink Configuration (Page 1)

Configure SiteLink Location	<ol style="list-style-type: none"> 1 Ensure the system is set up for SiteLink connectivity. See “System Configuration for SiteLink” on page 141. 2 Press the Setup key, select Connectivity, then select SiteLink Setup. If the Transfer Mode is changed, a dialog box is displayed to restart the system. 3 Select New and enter information in the following fields: <ul style="list-style-type: none"> • Host Name: Unique network name for the ultrasound system. Default is MicroMaxx. • Alias: Name used to identify the network location of the MicroMaxx. • IP Address: Unique identifier of the ultrasound system location. Cannot be between “127.0.0.0” and “127.0.0.8.” • Subnet Mask: Identifies a network subdivision. The default value is “255.255.0.0.” • Default Gateway: IP address where network connects to another network. Cannot be between “127.0.0.0” and “127.0.0.8.” • Alternate Gateway: Alternate location where network connects to another network. Cannot be between “127.0.0.0” and “127.0.0.8.” 4 In the Network Speed list, make the appropriate selection. 5 Select Save, then select Done from the on-screen menu. A dialog box is displayed to restart the system.
Select SiteLink Location	<ol style="list-style-type: none"> 1 Press the Setup key, then select Connectivity. 2 In the Location list, select the desired location. A dialog box is displayed to restart the system.
Delete Location	<ol style="list-style-type: none"> 1 Select the name of the location from the list of locations. 2 Select Delete. A dialog box is displayed. 3 Select Yes to delete and No to cancel. 4 Complete all configuration information, then select Done from the on-screen menu. A dialog box is displayed to restart the system.

Configuring SiteLink for Wireless

Note: Wireless connectivity for SiteLink is an optional feature.

Caution: To avoid damage to the wireless card, always turn off the ultrasound system before inserting or removing the wireless card.

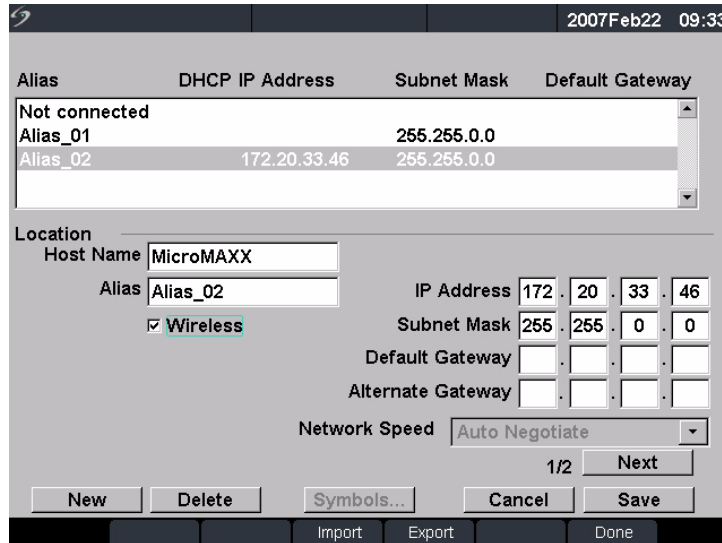

Figure 2 SiteLink Wireless Locations Configuration (Page 1)

Configure SiteLink Wireless Location (page 1)

Note: Only Symbol LA-4137 802.11b wireless CompactFlash cards are compatible with the MicroMaxx ultrasound system. Use only wireless cards supplied by SonoSite.

- 1 Turn system off, insert the wireless network card in back slot, and then turn system on.
- 2 Press the **Setup** key, select **Connectivity**, then select **SiteLink Setup**.
- 3 Select **New** and enter information in the following fields:
 - **Host Name:** MicroMaxx should be auto-filled in this field.
 - **Alias:** Enter a unique name to identify the location information.
 - **IP Address:** Enter a unique address using numbers from the first three fields of the router IP address and creating a unique number in the last field to identify this MicroMaxx system in the wireless network.
 - **Subnet Mask:** 255.255.0.0 should be auto-filled in this field.
 - **Default Gateway:** Optional.
 - **Alternate Gateway:** Optional.
 - **Network Speed:** Not available in wireless connectivity.
- 4 Select the **Wireless** check box.
- 5 Select **Next** to display page 2.

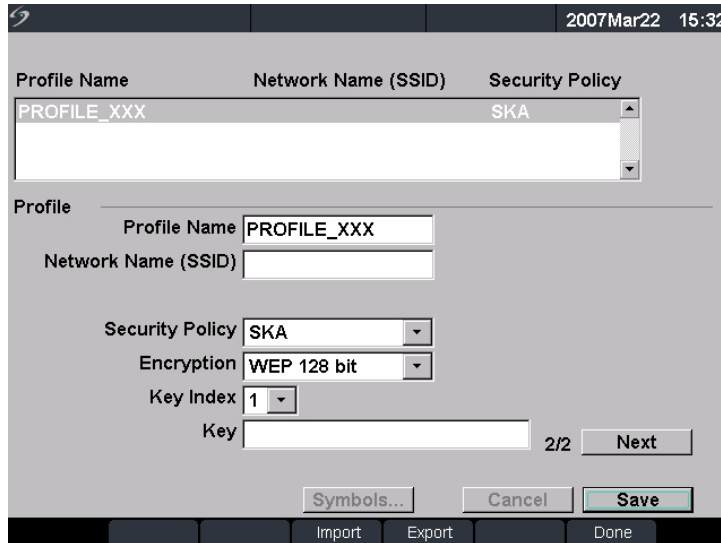

Figure 3 SiteLink Wireless Locations Configuration (Page 2)

Configure SiteLink Wireless Location (page 2)

- 1 Enter information in the following fields.
 The information entered in these fields must match exactly the information entered in the router setup. For information on installing and configuring the wireless router and wireless network card, see *MicroMaxx Wireless Installation Instructions*.
 - **Profile Name:** Name of profile set for this location.
 - **Network Name SSID:** This name is provided by the network administrator.
 - **Security Policy:** Security type that is used to authenticate with the network.
 The security settings on the router may be set to Auto or Shared Key. If Auto is selected, either Open or SKA may be selected on the MicroMaxx. If Shared Key is selected on the router setup, then SKA must be selected on the MicroMaxx.
 - **Encryption:** Encryption key type (64 bit or 128 bit).
 - **Key Index:** WEP key index 1-4.
 - **Key:** WEP key value used to encrypt data.
- 2 Select **Save**, then select **Done** from the on-screen menu.

-
- | | | |
|--|---|---|
| Select SiteLink Wireless Location | 1 | Press the Setup key, then select Connectivity . |
| | 2 | In the Location list, select the desired location.
A dialog box is displayed to restart the system. |
-
- | | | |
|-----------------------------------|---|--|
| Verify Wireless Connection | 1 | On your PC, open SiteLink Image Manager , then select Configure menu. |
| | 2 | On the Configure menu, select TCP/IP Port . |
| | 3 | Verify that the IP address in SiteLink matches the IP address in the ultrasound system.

Wireless is connected properly when the connection icon with strength bars and ultrasound system connected icon are displayed in system status on the ultrasound system. See <i>SiteLink Image Manager User Guide</i> . |

System Configuration for DICOM

Note: DICOM is an optional feature.

The system provides configuration pages for setting up DICOM devices for network connectivity. DICOM configuration pages typically are configured by network administrators or PACS managers.

Locations	List of locations for the system.
Archivers	Devices for storing patient images and clips.
Printers	Film printers for printing patient exam images.
Worklist	List of scheduled patient procedures used to enter patient data in the Patient Information form.
Procedure	List of system and user-defined procedures.

Perform the following procedures before beginning the ultrasound system configuration:

- [“System Connectivity Setup”](#) on page 141.
- [“Creating Backup for DICOM Settings”](#) on page 147.
- If your ultrasound system is wireless compatible, perform the standard DICOM setup, then continue with [Configure Wireless DICOM](#).

Creating Backup for DICOM Settings

Before configuring the system, SonoSite highly recommends saving the DICOM factory settings to a CompactFlash card and storing the card in a secure location.

-
- Create Backup**
- 1 Insert a blank CompactFlash card in the back slot. See [“Installing or Removing CompactFlash Card”](#) on page 12.
 - 2 Press the **Setup** key, select **Connectivity**, then select **DICOM Setup**.
 - 3 Select **Config** from the on-screen menu.
 - 4 Select **Export** from the on-screen menu.
 - 5 Turn the system off, then remove the CompactFlash card.

Configuring Locations

You can create up to 16 different locations on your MicroMaxx system. Locations must be set up prior to information transfer. When configuring your system for wireless use, it is done through the location setup process.

Note: Only one location can be set up to receive in-progress image transfers.

Configure DICOM for Ethernet

- Connect to LAN 1** Connect the Ethernet cable to the Ethernet interface cable, then connect to the Ethernet connection on the mini-dock or docking system. See the applicable SonoSite accessory user guide.
- 2 With the system on, check the LAN link light (green LED) next to the Ethernet connector to verify physical connection to LAN.

Alias	DHCP	IP Address	Subnet Mask	Default Gateway
Not connected				
Alias_01			255.255.0.0	
Alias_02			255.255.0.0	

Location

Host Name:

Alias:

AE Title:

DHCP

IP Address: . . .

Subnet Mask: . . .

Default Gateway: . . .

Alternate Gateway: . . .

Wireless

1/2

Log Import Export Done

Figure 4 DICOM Locations Configuration (Page 1)

**Configure
DICOM
Location
(Page 1)**

- 1 Ensure the system is set up for DICOM connectivity. See [“System Connectivity Setup”](#) on page 141.
- 2 Press the **Setup** key, select **Connectivity**, then select **DICOM Setup**.
- 3 Select **Config** from the on-screen menu.
- 4 Select **New**. See [Figure 4](#) on page 148.
- 5 Select **DHCP** to enable DHCP (Dynamic Host Configuration Protocol), if desired.

When DHCP is selected, the IP Address, Subnet Mask, Default Gateway, and Alternate Gateway fields are inactive.
- 6 Enter network information in the following fields:
 - **Host Name:** Unique network name for the ultrasound system. Default is MicroMaxx.
 - **Alias:** Name used to identify the network location of the MicroMaxx.
 - **AE Title:** DICOM Application Entity Title.
 - **Wireless:** If you are setting up SiteLink for wireless use, select the **Wireless** check box.
 - **IP Address:** Unique identifier of the ultrasound system location. Cannot be between “127.0.0.0” and “127.0.0.8.”
 - **Subnet Mask:** Identifies a network subdivision. The default value is “255.255.0.0.”
 - **Default Gateway:** IP address where network connects to another network. Cannot be between “127.0.0.0” and “127.0.0.8.”
 - **Alternate Gateway:** Alternate location where network connects to another network. Cannot be between “127.0.0.0” and “127.0.0.8.”
- 7 Select **Next** to display page 2.

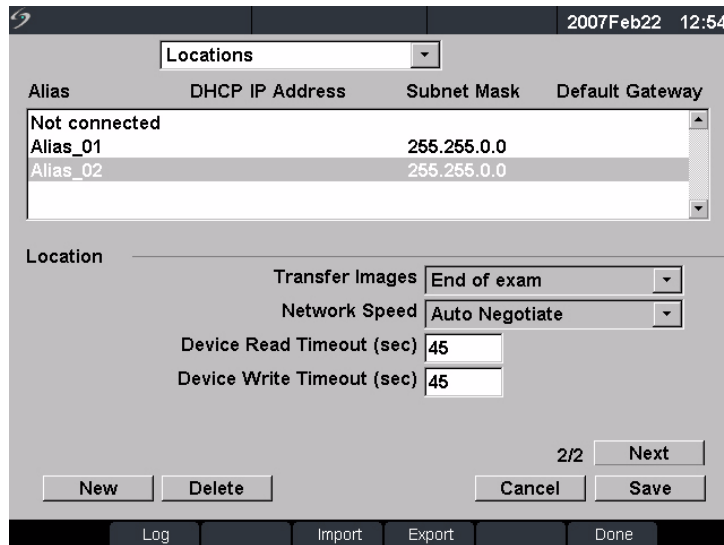

Figure 5 DICOM Locations Configuration (Page 2)

**Configure
DICOM
Location
(Page 2)**

- 1 Enter network information in the following fields. See [Figure 5](#).
 - **Transfer Images:** Select to transfer images during or at end of exam.
 - **Network Speed** (Not available with wireless setup): Select Auto, full, or half duplex.
 - **Device Read Timeout** (sec): Time system keeps network line open when attempting, but not receiving information
 - **Device Write Timeout** (sec): Time system keeps network line open when attempting, but not sending information.

Note: If setting up a wireless connection, see [“Configure DICOM Wireless Locations \(Page 3\)”](#) on page 152.
- 2 Select **Save**, then select **Done** from the on-screen menu.

Configure DICOM for Wireless

Note: Wireless connectivity for DICOM is an optional feature.

Caution: To avoid damage to the wireless card, always turn off the ultrasound system before inserting or removing the wireless card.

The screenshot shows a configuration window titled "Locations" with a date and time of "2007Mar22 15:34". The window is divided into two main sections: "Profile Name" and "Profile".

Profile Name Section:

- Profile Name: PROFILE_XXX
- Network Name (SSID): [Empty field]
- Security Policy: SKA

Profile Section:

- Profile Name: PROFILE_XXX
- Network Name (SSID): [Empty field]
- Security Policy: SKA
- Encryption: WEP 128 bit
- Key Index: 1
- Key: [Empty field]

Buttons: Symbols..., Cancel, Save, Next, 3/3

Footer: Log, Import, Export, Done

Figure 6 DICOM Locations Wireless Configuration (Page 3)

**Configure
DICOM
Wireless
Locations
(Page 3)**

Note: Only Symbol LA-4137 802.11b wireless CompactFlash cards are compatible with the MicroMaxx ultrasound system. Use only wireless cards supplied by SonoSite.

- 1 Turn system off, insert the wireless network card in back slot, and then turn system on.
- 2 Press the **Setup** key, select **Connectivity**, then select **DICOM Setup**.
If the Transfer Mode is changed, a dialog box is displayed to restart the system.
- 3 Perform steps in [“Configure DICOM Location \(Page 1\)”](#) on page 149.
- 4 Select the **Wireless** check box.
- 5 Select **Next** to display page 2, then perform steps in [“Configure DICOM Location \(Page 2\)”](#) on page 150.
- 6 Select **Next** to display page 3. See [Figure 6](#) on page 151.
- 7 Enter information in the following fields:
The information entered in these fields must match exactly the information entered in the router setup. For information on installing/configuring wireless router and wireless network card, see *MicroMaxx Wireless Installation Instructions*.
 - **Profile Name:** Name of profile set for this location.
 - **Network Name SSID:** This name is provided by the network administrator.
 - **Security Policy:** Security type that is used to authenticate with the network.
The security settings on the router may be set to Auto or Shared Key. If Auto is selected, either Open or SKA may be selected on the MicroMaxx. If Shared Key is selected on the router setup, then SKA must be selected on the MicroMaxx.
 - **Encryption:** Encryption key type (64 bit or 128 bit).
 - **Key Index:** WEP key index 1-4.
 - **Key:** WEP key value used to encrypt data.
- 8 Select **Save**, then select **Done** from the on-screen menu.

**Select DICOM
Service Class
Provider (SCP)**

- 1 On the DICOM Location screen, select the wireless location you just created.
- 2 Select a preconfigured SCP device type(s).
- 3 Select **Done** from the on-screen menu.
You are prompted to reboot the system.
- 4 Press the **Setup** key, then select **Connectivity**.
- 5 Select **DICOM Setup**.
- 6 Select **Verify**.
The Status column shows whether verification passed or failed for each selected SCP.

-
- Verify Wireless Connection**
- 1 Verify that the connection icon with strength bars and ultrasound connected icon are displayed in system status on the ultrasound system.
 - 2 Send test data sample to verify wireless connection is set up and configured properly.
-

- Delete Location**
- 1 Select the name of the location from the list of locations.
 - 2 Select **Delete**.
A dialog box is displayed.
 - 3 Select **Yes** to delete and **No** to cancel.
 - 4 Complete all configuration information, then select **Done** from the on-screen menu.
A dialog box is displayed to restart the system.

Configuring Archivers

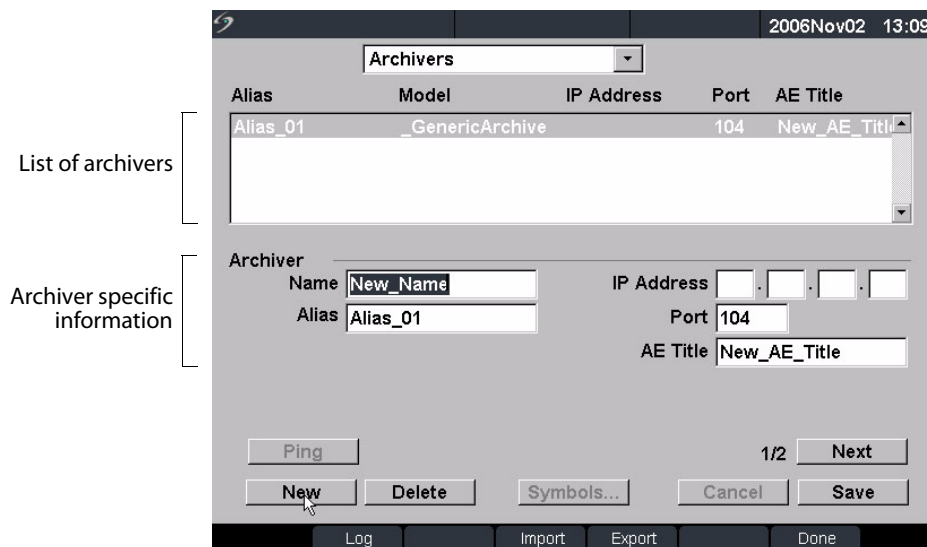

Figure 7 Archivers Configuration (Page 1)

Name	Network host name for an archiver.
Alias	Personalized name for an archiver.
IP Address	Unique identifier for the archiver.
Port	Device port number. IP port 104 is normally assigned for DICOM.
AE Title	Archiver DICOM Application Entity Title.
Ping	Utility to determine whether a specific IP address is accessible.

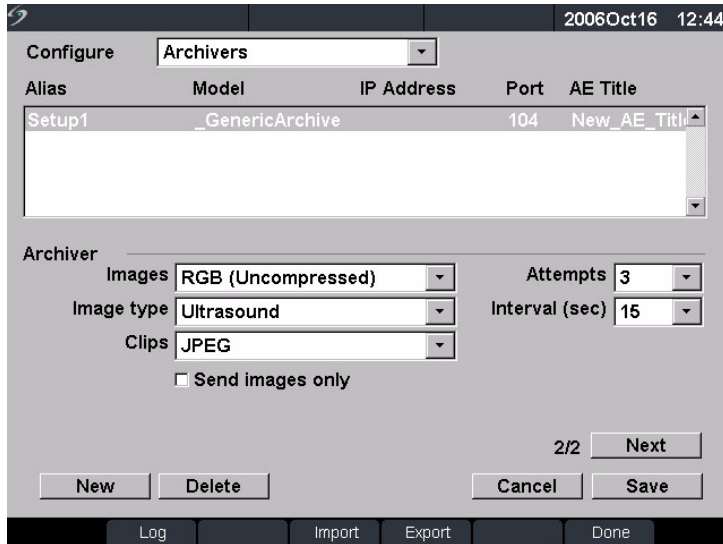

Figure 8 Archivers Configuration (Page2)

Images	Defines how images are sent to the archiver; selections include: RGB (uncompressed), Mono (uncompressed), and JPEG.
Image Type	List of archiver image types, based on capture mode.
Clips	Defines how clips are sent to the archiver; selections include: RGB (uncompressed), Mono (uncompressed), and JPEG.
Attempts	Number of times the system tries to resend a failed transfer.
Interval	Amount of time between attempts.
Send Images Only	Limits transfer to images only; clips are not sent (available only when Image Type is set to Ultrasound).

-
- Configure New Archiver**
- 1 Ensure the system is set up for DICOM connectivity. See [“System Configuration for DICOM”](#) on page 147.
 - 2 Press the **Setup** key, select **Connectivity**, then select **DICOM Setup**.
 - 3 Select **Config** from the on-screen menu.
 - 4 In the **Configure** list, select **Archivers**.
 - 5 Select **New**.
 - 6 Enter information in the fields (pages 1 and 2).
 - Name: Cannot contain special characters.
 - Alias and AE Title: May contain special characters.
 - IP Address and Port: Must be entered before the information is saved. To use special characters, select Symbols. See [“Enter Symbol/Special Character”](#) on page 23.Use the spacebar on the keyboard to enter the underscore symbol.
Select **Cancel** to undo last change.
 - 7 Select **Save**.
 - 8 Complete all configuration information and then select **Done** from the on-screen menu.
A dialog box is displayed to restart the system.
-

- Delete Archiver**
- 1 Select the name of the device from the list of archivers.
 - 2 Select **Delete**.
A dialog box is displayed.
 - 3 Select **Yes** to delete and **No** to cancel.
 - 4 Complete all configuration information and then select **Done** from the on-screen menu.
A dialog box is displayed to restart the system.

Configuring Printers

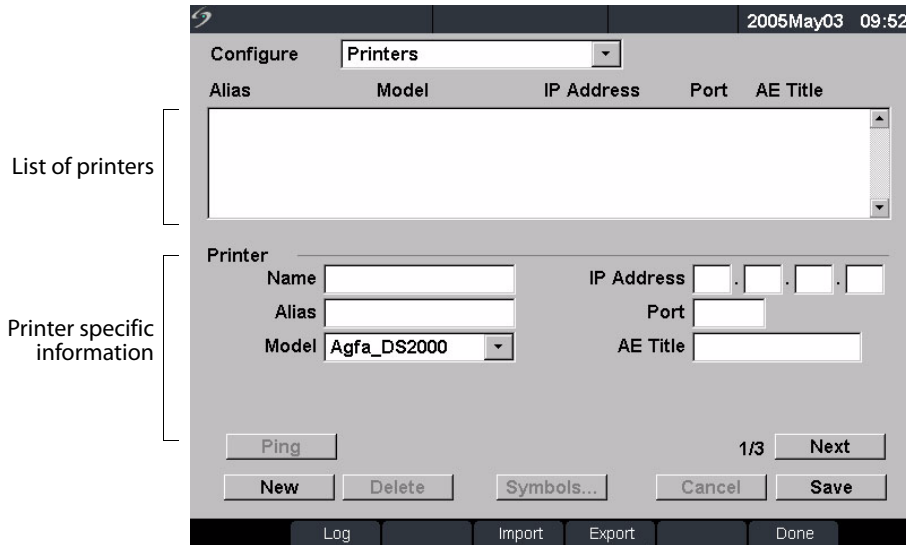

Figure 9 Printers Configuration (Page 1)

Name	Network host name for a printer.
Alias	Personalized name for a printer.
Model	List of Agfa, Codonics, and Kodak printer models. If a specific model is not listed, choose one of the generic models at the end of the list.
IP Address	Unique identifier for the printer.
Port	Device port number. IP port 104 is normally assigned for DICOM.
AE Title	Printer DICOM Application Entity Title.
Ping	Utility to determine whether a specific IP address is accessible.

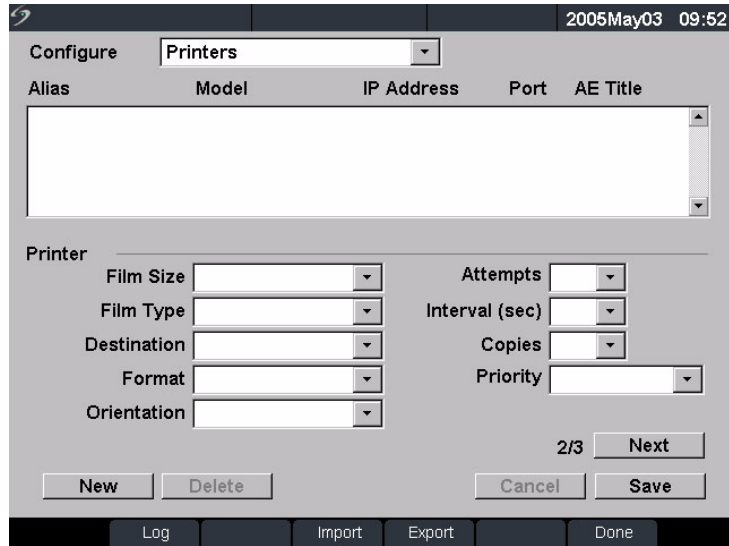

Figure 10 Printers Configuration (Page 2)

Film Size	Film sizes supported by the printer.
Film Type	Film medium supported by the printer.
Destination	Location film is placed after it is printed.
Format	Number of columns and rows in the image printout.
Orientation	Film layout.
Attempts	Number of times the system tries to resend a failed image transfer.
Interval	Amount of time between attempts.
Copies	Number of copies to print for each image.
Priority	Importance of the print job.

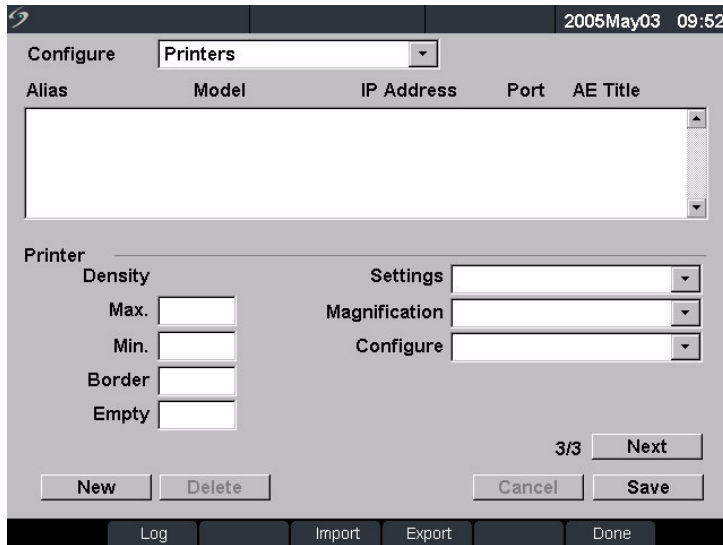

Figure 11 Printers Configuration (Page 3)

Max. Density	Maximum density of the black value.*
Min. Density	Minimum density of the white value.*
Border Density	Density of the areas surrounding and between film images.*
Empty Density	Empty image density.*
Settings	Defines how images are sent to the printer, either as Color (RGB) or Monochrome images.
Magnification	Type of interpolation used during printing.
Configure	Printer-specific configuration value. If using generic printer settings, no configuration strings are available.

* In hundredths of optical density (OD)

-
- Configure New Printer**
- 1 Ensure the system is set up for DICOM connectivity. See [“System Configuration for DICOM”](#) on page 147.
 - 2 Press the **Setup** key, select **Connectivity**, then select **DICOM Setup**.
 - 3 Select **Config** from the on-screen menu.
 - 4 In the **Configure** list, select **Printers**.
 - 5 Select **New**.
 - 6 Enter information in the fields (pages 1, 2, and 3).
 - Name: Cannot contain special characters.
 - Alias and AE Title: May contain special characters.
 - IP Address and Port: Must be entered before the information is saved.To use special characters, select Symbols. See [“Enter Symbol/Special Character”](#) on page 23.
Use the spacebar on the keyboard to enter the underscore symbol.
Select **Cancel** to undo last change.
 - 7 Select **Save**.
 - 8 Complete all configuration information and then select **Done** from the on-screen menu.
A dialog box is displayed to restart the system.
-

- Delete Printer**
- 1 Select the name of the device from the list of printers.
 - 2 Select **Delete**.
A dialog box is displayed.
 - 3 Select **Yes** to delete and **No** to cancel.
 - 4 Complete all configuration information and then select **Done** from the on-screen menu.
A dialog box is displayed to restart the system.

Configuring Worklist Servers

Configure Worklist Servers 2005May03 09:52

Alias	Model	IP Address	Port	AE Title
-------	-------	------------	------	----------

Worklist

Name IP Address

Alias Port

AE Title

Ping 1/2 Next

New Delete Symbols... Cancel Save

Log Import Export Done

Figure 12 Worklist Configuration (Page 1)

Name	Network host name for a worklist server.
Alias	Personalized name for a worklist server.
AE Title	Application Entity Title.
IP Address	Unique identifier for the worklist server.
Port	Device port number. IP port 104 is normally assigned for DICOM.

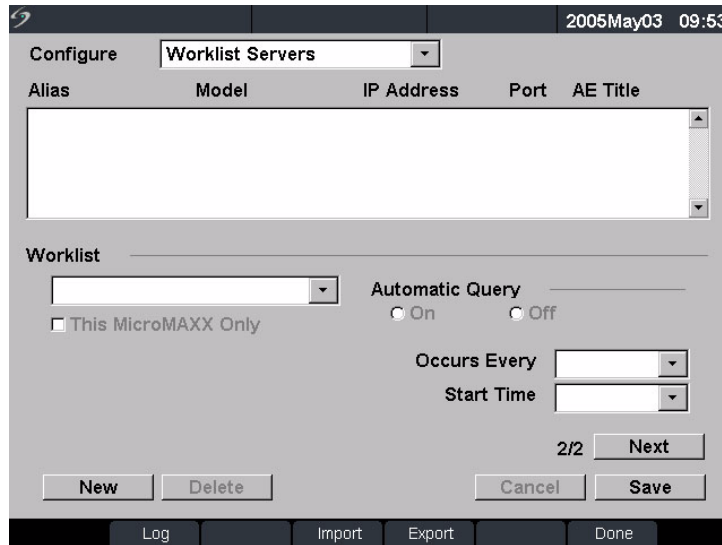

Figure 13 Worklist Configuration (Page 2)

Date Range	Defines the date range for manual or automatic queries.
This MicroMAXX Only	Restricts the query to patient procedures that are scheduled for the system based on its AE Title.
Automatic Query	Turns automatic query on/off.
Occurs Every	An option for an automatic query to select the length of time between automatic updates.
Start Time	An option for an automatic query to select the start time for the automatic update (displayed in 24 hour time).

The following table identifies the parameters used for worklist queries.

Table 1: Manual and Automatic Query Parameters

Item	Manual Patient Query	Manual Update from Worklist	Automatic Query Update
Patient data	X		
Date Range	X	X	X
This MicroMAXX Only		X	X
Automatic Query On/Off			X
Occurs Every			X
Start Time			X

- Configure New Worklist Server**
- 1 Ensure the system is set up for DICOM connectivity. See [“System Configuration for DICOM”](#) on page 147.
 - 2 Press the **Setup** key, select **Connectivity**, then select **DICOM Setup**.
 - 3 Select **Config** from the on-screen menu.
 - 4 In the **Configure** list, select **Worklist Servers**.
 - 5 Select **New**.
 - 6 Enter information in the fields (pages 1 and 2).
 - Name: Cannot contain special characters.
 - Alias and AE Title: May contain special characters.
 - IP Address and Port: Must be entered before the information is saved.
 To use special characters, select Symbols. See [“Enter Symbol/Special Character”](#) on page 23.
 Use the spacebar on the keyboard to enter the underscore symbol.
 Select **Cancel** to undo last change.
 - 7 Select **Save**.
 - 8 Complete all configuration information and then select **Done** from the on-screen menu.
 A dialog box is displayed to restart the system.

-
- | | |
|-------------------------------|---|
| Set Up | 1 Press the Setup key, select Connectivity , then select DICOM Setup . |
| Automatic Query Update | 2 Select Config from the on-screen menu. |
| | 3 In the Configure list, select Worklist Servers . |
| | 4 In Automatic Query (page 2), select On . |
| | 5 In the Occurs Every list, select the desired length of time between automatic updates. |
| | 6 In the Start Time list, select the start time for the automatic updates. |
| | 7 Select Done from the on-screen menu. |
| | A dialog box is displayed to restart the system. |
-
- | | |
|-------------------------------|---|
| Delete Worklist Server | 1 Select the name of the device from the worklist. |
| | 2 Select Delete . |
| | A dialog box is displayed. |
| | 3 Select Yes to delete and No to cancel. |
| | 4 Complete all configuration information and then select Done from the on-screen menu. |
| | A dialog box is displayed to restart the system. |
-

Configuring Procedures

Procedures are automatically added to the procedure list when new exam types from the patient procedures are selected from the worklist.

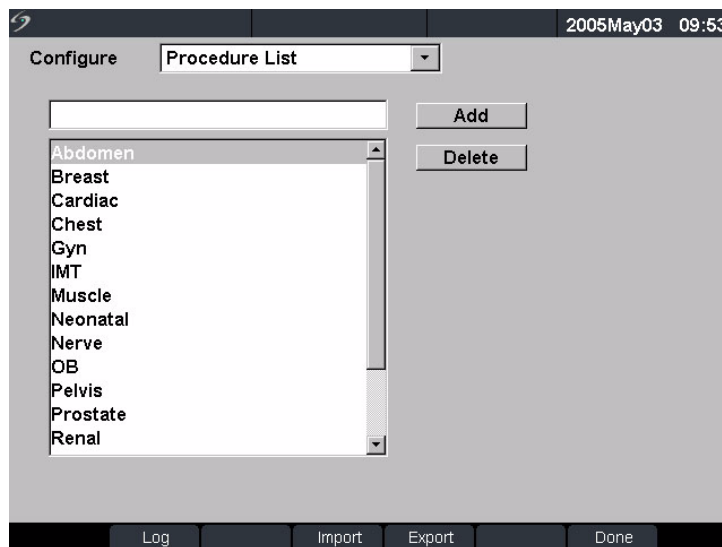

Figure 14 Procedure Configuration

Add New Procedure	1	Ensure the system is set up for DICOM connectivity. See “System Configuration for DICOM” on page 147.
	2	Press the Setup key, select Connectivity , then select DICOM Setup .
	3	Select Config from the on-screen menu.
	4	In the Configure list, select Procedure List .
	5	Type desired text.
	6	Select Add .
	7	Select Done from the on-screen menu.
Delete Procedure	1	Select the name of the procedure from the list of procedures.
	2	Select Delete .
	3	Select Done from the on-screen menu.

Importing and Exporting Configurations

All configuration data for the locations (except IP addresses and AE titles), archivers, printers, and worklists can be imported and exported. This allows you to share configuration data between systems. The import and export functions are accessed on any DICOM configuration page.

Export Configuration Data	1	Complete all pages of the configuration for one system.
	2	Insert a blank CompactFlash card in the back slot. See “Installing or Removing CompactFlash Card” on page 12.
	3	Press the Setup key, select Connectivity , then select DICOM Setup .
	4	Select Config from the on-screen menu.
	5	Select Export from the on-screen menu. All configuration data for the locations, archivers, printers, and worklists except system location IP addresses, are copied to the CompactFlash card.
	6	Remove the CompactFlash card.
Import Configuration Data	1	Insert the CompactFlash card in the back slot of the system. See “Installing or Removing CompactFlash Card” on page 12.
	2	Press the Setup key, select Connectivity , then select DICOM Setup .
	3	Select Config from the on-screen menu.
	4	Select Import from the on-screen menu. After all files are imported, the system restarts. <ul style="list-style-type: none"> • All configurations currently on the system are replaced with imported data. • Manually enter the IP addresses and AE titles for locations on the receiving system.
	5	Complete all configuration information and then select Done from the on-screen menu. A dialog box is displayed to restart the system.

Reviewing the Network Log

The Network Log function is accessible on any DICOM configuration page. The log collects network errors and events, typically to support diagnostics and can be exported to a CompactFlash card and read by a CompactFlash reader. The log contents are saved when the system is turned off. The log has a finite amount of space and writes over existing information when it is full.

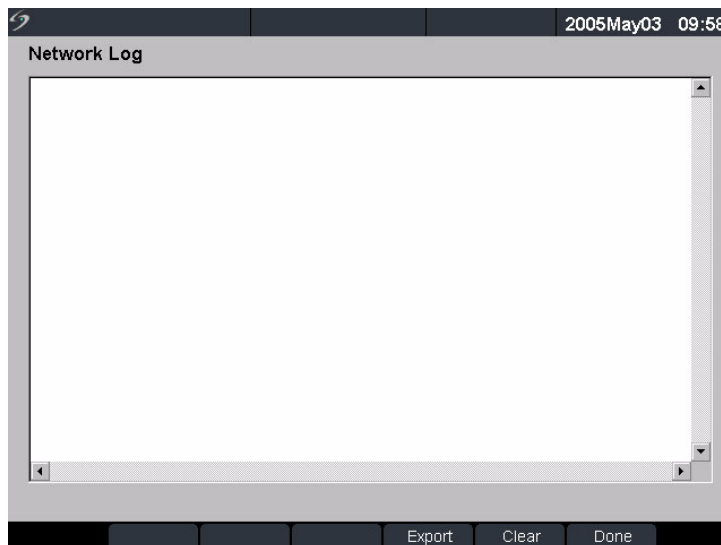

Figure 15 Network Log

Clear	Deletes all entries from the log.
Export	Copies the contents of the log to the CompactFlash card (back slot). The log file is named log.txt on the CompactFlash card.
Done	Returns to the previous page.

Export Log

Note: The Event log and the DICOM network log have the same filename (log.txt). When you export either one to the same CompactFlash card, it will overwrite the existing log.txt file.

- 1 Insert the CompactFlash card in the back slot of the system.
- 2 Press the **Setup** key, select **Connectivity**, then select **DICOM Setup**.
- 3 Select **Log** and then **Export** from the on-screen menu.
- 4 View the files on a CompactFlash reader.

The log is a text file that can be opened by a text file application, for example, Microsoft Word or Notepad. The log file is named log.txt.

-
- Clear Log**
- 1 Press the **Setup** key, select **Connectivity**, then select **DICOM Setup**.
 - 2 Select **Log** from the on-screen menu.
 - 3 Select **Clear** from the on-screen menu to delete all text.
A dialog box is displayed.
 - 4 Select **Yes** to delete or **No** to cancel.
 - 5 Select **Done** to return to the previous menu.

DICOM Usage

The system can be connected through a LAN to send images and clips from single or multiple network locations to single or multiple devices (printers, archivers, or worklists). The system can be configured to recognize a maximum of 16 printers, 16 archivers, and 16 worklist servers. From each location, you may select a maximum of two printers, four archivers, and one worklist server. Each device selected will receive the files that you transfer.

Based on your connectivity needs, DICOM can be configured in the following ways:

- Stationary system location transferring to a single device or to multiple devices.
- Mobile system locations (user selects between multiple locations within the facility) transferring to a single device or to multiple devices.

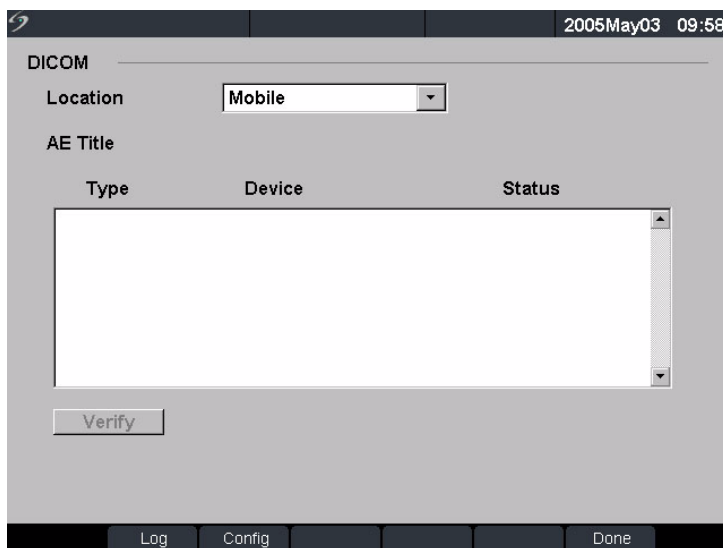

Figure 16 DICOM Main Screen

Location	Geographical location which identifies the network where the system is connected. Network and DICOM device settings can be independently configured for each defined location.
----------	--

AE Title	Refers to the Application Entity, the name by which the DICOM devices on the LAN knows the system.
Type	Type of device: archiver, printer, or worklist server.
Device	Name by which the system knows the printer, archiver, or worklist server.
Status	Indication of whether the device is available for use.
Verify	Test to ensure that the selected devices can communicate with the ultrasound system.
Log	Log file for troubleshooting DICOM problems. (See “Reviewing the Network Log” on page 166.)
Config	Access to a series of pages for configuring network devices.
Done	Returns to the previous page if no changes are made or restarts the system if changes are made.

Select Location, Archiver, Printer, or Worklist Server	<p><i>Note: The system must be configured before using DICOM.</i></p> <ol style="list-style-type: none"> 1 Press the Setup key, select Connectivity, then select DICOM Setup. 2 In the Location list, select the current location of the system. 3 In the Device list, select one or more archivers, printers, or worklist servers. <ul style="list-style-type: none"> • A check mark is displayed next to each device selected. • A maximum of two printers, four archivers, and one worklist server may be selected for each location. • Only one archiver may be selected to receive in-progress image transfers. 4 Complete all configuration information and then select Done from the on-screen menu. <p>A dialog box is displayed to restart the system.</p>
Verify Status of Archiver, Printer, or Worklist Server	<ol style="list-style-type: none"> 1 Press the Setup key, select Connectivity, then select DICOM Setup. 2 From the Device list, select the desired device or devices. 3 Select Done from the on-screen menu. <p>A dialog box is displayed to restart the system.</p> 4 Press the Setup key, select Connectivity, then select DICOM Setup. 5 Select Verify to confirm that a printer, archiver, or worklist server is connected. <p>The connection status of the device is identified in the Device list. If the verify button is disabled, restart the system.</p>

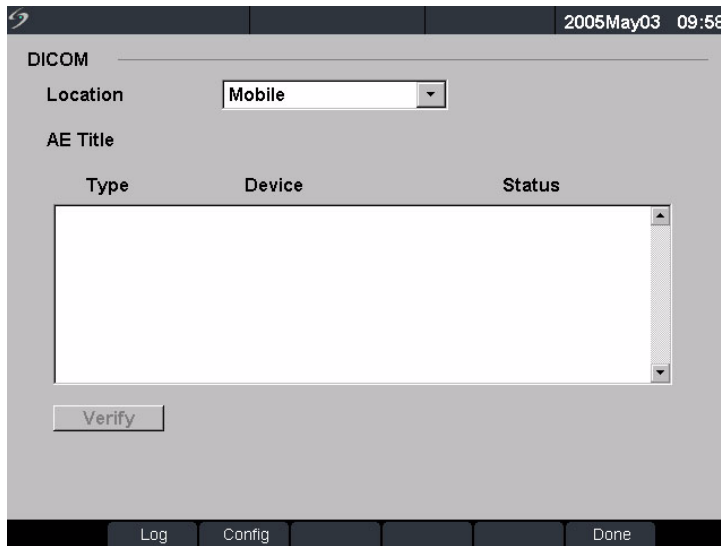

Figure 17 DICOM Main Screen Post Verify

Failed	DICOM communication with the selected device was unsuccessful.
Success	DICOM communication with the selected device was accomplished.
Unknown	DICOM device does not support the C-ECHO (for example, verify query command).

DICOM Image Archive and Print

Images and clips are sent from the ultrasound system to a PACS server or printer using an Ethernet connection. The images and clips are automatically sent when the system detects an Ethernet connection.



This icon is present and animated when the ultrasound system is connected and images and clips are archiving.

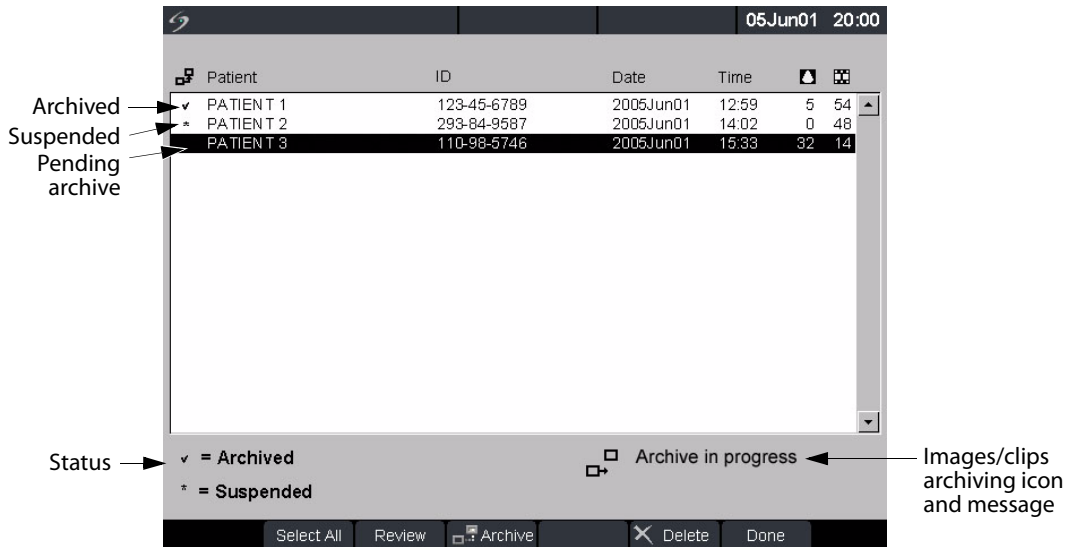

Figure 18 Patient List

Automatically Archive or Print Images Images and clips are automatically transferred to the selected devices. Pending exams are archived or printed starting at the top of the list. The network connection icon in the system status area is animated during DICOM network activity.

- 1 Ensure the current location is selected in the DICOM main screen.
- 2 Ensure connection to LAN. See [“Connect to LAN”](#) on page 148.
With the system on, check the LAN link light (green LED) next to the mini-dock connector to verify physical connection to LAN.
- 3 Verify patient exam is closed. See [“Patient Information”](#) on page 49.
 - Images and clips saved on the ultrasound system are stored on a CompactFlash. See [“Image and Clip Storage”](#) on page 70. Images and clips transferred to DICOM devices are automatically sent from the CompactFlash after you end the exam.
 - All images and clips in the patient exams are sent at once to the DICOM devices, rather than the individual images.
 - The DICOM formatted files are not saved to the CompactFlash card. File transfer of pending patient exams occurs only when you end the exam or create a new patient.

Verify Images and Clips Sent Press the **Review** key.
 The Patient List indicates the status of image and clip transfer. See [Figure 18](#) on page 170.

- Patient exams that are checked are archived.
- Patient exams that are not checked are pending archive.
- Patient exams that are identified with an asterisk are suspended.

Transfer of images and clips is suspended when the system executes the number of Attempts and Interval configured in the configuration setup. These exams need to be manually archived.

Manually Archive or Print Images

- 1 Verify that the ultrasound system is turned on and the correct location is selected.
 With the system on, check the LAN link light (green LED) next to the mini-dock connector to verify physical connection to LAN.
 The network connection icon in the system status area is animated during DICOM network activity when images are transferred.
- 2 Press the **Review** key on the ultrasound system.
 or
 If there is a current patient, select **List** from the on-screen menu.
- 3 Select an individual patient exam or **Select All** from the on-screen menu.
- 4 Select **Archive** from the on-screen menu. (Any check marks or asterisks are removed.)
 Once archived, a check mark reappears to the left of the selected patient's name.

Patient Information

The patient information form is used to enter patient data into the system. See “[Patient Information](#)” on page 49 for information on completing fields on the form. The options listed below are only available in DICOM Worklist.

New Patient  1 Press the **Patient** key.
 2 Select **New** from the on-screen menu.
 This ends the current patient procedure.

- Selecting new patient erases any previously entered information, including any calculations and report pages.
- To save this information, save the screen for each item, for example report pages, patient information, calculations, and graphs.

3 Enter information into appropriate fields.

Procedure Type Select the procedure type (only available when DICOM Worklist feature is licensed and configured).

Procedure ID Enter desired identification information. The field is editable when performing a manual patient query.

Query

The Query on-screen menu is displayed when the following is set up:

- Data is entered in the following fields:
 - Patient: Last, First, Middle
 - Patient ID
 - Accession
 - Procedure ID
- System is connected to a LAN
- Worklist server is active

See [“Manual Patient Query”](#) on page 173.

Worklist

- 1 Press the **Patient** key.
- 2 Select **Worklist** from the on-screen menu to view all scheduled patient procedures that have been queried by the system.

DICOM Worklists

DICOM worklist provides the ability to import patient data from the Hospital Information System or Radiology Information System. The patient information form also provides the ability to enter specific patient data and query the worklist server for a matching patient procedure.

The system's worklist capability functions only when the following is set up:

- The system is configured before using DICOM. See [“System Configuration for DICOM”](#) on page 147.
- The system is connected to a LAN. See [“Connect to LAN”](#) on page 148.
- A worklist server has been configured for the active location.

Manual Patient Query	<ol style="list-style-type: none"> 1 Ensure that a worklist server is configured and is communicating with the system by selecting Verify on the main DICOM configuration screen. 2 Press the Patient key. 3 Select New from the on-screen menu. This ends the current patient procedure. <ul style="list-style-type: none"> • Selecting new patient ends the existing exam and erases any previously entered information, including any calculations and report pages. • To save this information, save the screen for each item, for example, report pages, patient information, calculations, and graphs. 4 Enter data in any of the following six fields: Patient: Last, First, Middle; Accession Number, Patient ID, or Procedure ID. A query is made on the character or characters, for example, searching for Smith will return Smith, Smithson, Smithy. 5 Select Query from the on-screen menu. After the query has completed, the total number of patient procedures matching the query is displayed in the lower right corner of the screen. 6 Highlight the desired patient procedure and then Select from the on-screen menu. The information is displayed on the Patient Information form. 7 In the Type list, edit the desired procedure type, if required. 8 Select More to enter information on page 2. 9 Select Done from the on-screen to return to previous page.
Manual Worklist Update	<ol style="list-style-type: none"> 1 Press the Patient key. 2 Select Worklist from the on-screen menu, then select Update from the on-screen menu.
Automatic Worklist Update	<ol style="list-style-type: none"> 1 Ensure system is turned on and connected to the LAN. See “Configure DICOM Location (Page 1)” on page 149. 2 Ensure system is set up for an automatic worklist query. See “Set Up Automatic Query Update” on page 164. The worklist is automatically updated. 3 Verify the current system date and time.
Sort Worklist	<ol style="list-style-type: none"> 1 Press the Patient key. 2 Select Worklist from the on-screen menu. 3 Select the desired column heading (Name, ID, Accession, Procedure, or Date). The worklist is sorted in ascending order.

Chapter 6: Troubleshooting and Maintenance

This chapter contains information to help you correct problems with system operation and provides instructions on the proper care of the system, transducer, and accessories.

Troubleshooting

If you encounter difficulty with the system, use the information in this chapter to help correct the problem. If the problem is not covered here, contact SonoSite Technical Support at the following numbers or addresses:

Technical Support	1-877-657-8118
International technical support:	Contact your local representative or call 425-951-1330
Technical Support fax:	1-425-951-6700
Technical Support e-mail:	service@sonosite.com
SonoSite website:	www.sonosite.com and select Support & Service

Table 1: Troubleshooting

Symptom	Solution
System will not power on.	Check all power connections. Perform the following sequence: remove DC input connector and battery; wait 10 seconds; connect DC input or install battery; press the power key. Ensure the battery is charged.
System image quality is poor.	Adjust the LCD screen to improve viewing angle. Adjust the brightness, as necessary, to improve image quality. Adjust the gain.
No CPD image.	Adjust the gain.
No Color image.	Adjust the gain or the scale.
No OB measurement selections.	Select the OB exam type.

Table 1: Troubleshooting (Continued)

Symptom	Solution
Print does not work.	Set the correct printer in system setup. Check the printer connections. Check the printer to ensure that it is turned on and set up properly. See the printer manufacturer's instructions, if necessary.
DVD/VCR does not record.	Check the DVD/VCR connections. Check the DVD/VCR to ensure that it is turned on and set up properly. See applicable SonoSite accessory user guide and the manufacturers' instructions, if necessary.
External monitor does not work.	Check the monitor connections. Check the monitor to ensure that it is turned on and set up properly. See the monitor manufacturers' instructions, if necessary.
Unexpected labels using the function keys.	Ensure labels have been assigned to the function keys.
Inaccurate fetal age calculation.	Ensure that the patient information, date, and time are set accurately.
System does not recognize the transducer.	Disconnect and reconnect the transducer.
Text cursor does not move when touchpad or arrows are selected.	Text cursor is constrained to one line.
A maintenance icon  displays on the system screen.	This icon indicates that system maintenance may be required. Record the number in parentheses on the C: line and contact SonoSite or your SonoSite representative.

Software Licensing

SonoSite software is controlled by a license key, which is obtained from SonoSite or from its authorized representatives. You must obtain one key for each system or transducer that will use the new software. See [“Obtaining a License Key”](#) on page 184.

The software may be installed and will operate for a short period of time without requiring a valid license key. We refer to this period of time as the “grace period.” The grace period is variable.

When you first install your software, your SonoSite system prompts you for a license key. If you have not yet obtained a valid license key, you can elect to use the software as long as the grace period time has not been fully consumed.

When a system is running in the grace period, all system functions are available. As you use the system, the grace period is slowly consumed. When the grace period has expired, the system will not be usable until a valid license key has been entered. Grace period time is not consumed while the system is powered off or when it is in “sleep” mode. Whenever a system is running in the grace period, the grace period time remaining is available on the license update screen.

Caution: | When the grace period expires, all system functions except for licensing are unavailable until a valid license key is entered into the system.

Upgrading the System and Transducer Software

As described in the [“About the System Software”](#) on page 8, software upgrades are provided on CompactFlash cards, which are installed in the back CompactFlash slot on the right hand side of the system. Upgrades provided may be required or optional.

Whenever you install a CompactFlash card containing a newer version of software into the system, the system will determine the level of software, prepare the system for the upgrade, and then install the new software onto the system.

When a CompactFlash card contains new transducer software and the transducer that requires a software upgrade is connected, the system prompts the user that the transducer requires the upgrade.

Caution: | To avoid damage to the ultrasound system or transducer, do not remove the upgrade card during the upgrade process.

-
- Upgrade System Software**
- 1 Remove any transducer or Triple Transducer Connect from the system.
 - 2 Connect the system directly to the power supply or through the mini-dock/docking system. See the SonoSite accessories user guide.
 - 3 Insert the CompactFlash card into the back slot.
The system displays the following message:



Figure 1 Upgrade System Software

- 4 Select **Yes** to accept or **No** to cancel the upgrade.
When you accept the system software upgrade, the system begins to load the new software and prepare for the upgrade and displays the following message:



Figure 2 System Software Loading

When the software upgrade has prepared the system for upgrade, the system displays the following message:



Figure 3 System Software Step 1 Restart

5 Select **Restart**.

After restart, there is a short delay before the system goes into the upgrade process. Do not turn the system off. The system displays the following message:



Figure 4 System Software Installation

When the upgrade is completed, the system displays the following message:

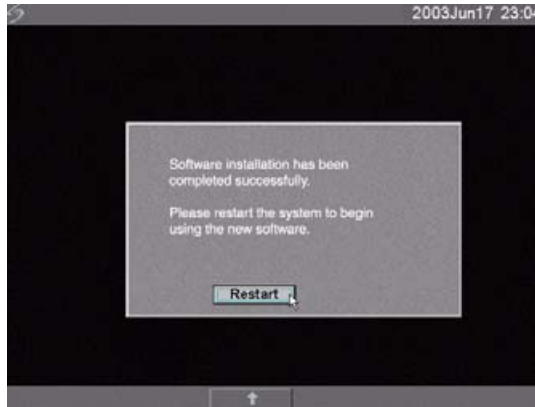

Figure 5 System Software Step 2 Restart

6 Select **Restart**.

When the operating software has been replaced, the system presents you with the license update screen so that you may license the software. If upgrading a transducer, press Cancel from the on-screen menu.

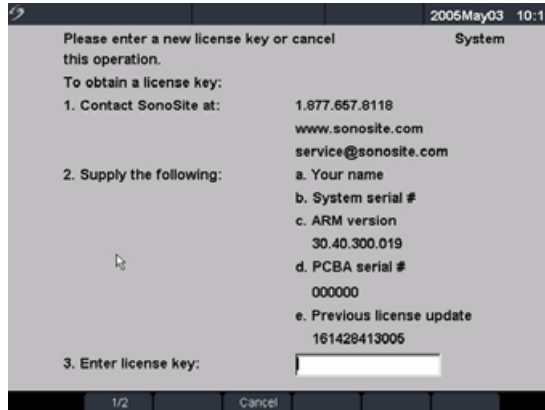

Figure 6 System Software License Key

At this point, the software upgrade process is complete, but the software is not yet licensed. See [“Obtaining a License Key”](#) on page 184.

Note: If you are upgrading a system and one or more transducers, it is recommended to upgrade all items before calling SonoSite Technical Support for your license keys. To postpone obtaining a license key, press Cancel from the on-screen menu.

Caution: To avoid damage to the ultrasound system or transducer, do not remove the upgrade card during the upgrade process.

**Upgrade
Transducer
Software**

Note: Connect the transducer directly to the ultrasound system. Do not upgrade using the Triple Transducer Connect. Do not remove the transducer from the system until the license page is displayed on the system.

- 1 Turn the system off and remove the CompactFlash card from the back slot.
- 2 Connect the transducer for the upgrade.
- 3 Turn the system on.
- 4 Wait approximately 10 seconds and then insert the upgrade CompactFlash card.



Figure 7 Incompatible Transducer Update

This screen is not displayed for compatible transducers.



Figure 8 Upgrade Transducer Software

- 5 Select **Upgrade** to accept or **Cancel** to cancel the upgrade.
When you accept the transducer software upgrade, the system loads the new software and displays the following message:



Figure 9 Transducer Software Loading

When the upgrade is completed, the system displays the following message:



Figure 10 Transducer Software Installation

- 6 Select **Restart**.
When the transducer software has been replaced, the system presents you with the license update screen so that you may license the software for your transducer. Upgrade all transducers before obtaining license keys. Repeat all steps in ["Upgrade Transducer Software"](#).

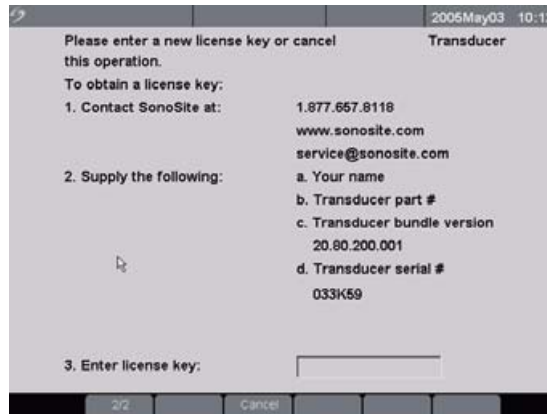

Figure 11 Transducer License Screen

At this point, the software upgrade process is complete, but the software is not yet licensed. The following section [“Obtaining a License Key”](#) explains how to license your system and transducer software.

Note: If you are upgrading additional transducers, it is recommended to upgrade all items before calling SonoSite Technical Support for your license keys. To postpone obtaining a license key, press Cancel from the on-screen menu.

Upgrading Triple Transducer Connect (TTC)

Upgrade TTC If the TTC requires an upgrade for the MicroMaxx system, the following message is displayed: “Do you want to upgrade the Triple Transducer Connect now?” If this message is displayed, perform the upgrade.

Select **Yes** to accept and **No** to cancel the upgrade.

- If you select Yes, the system presents you with the license update screen so that you may license the software. See [“Obtaining a License Key”](#) on page 184 to license your software.
- If you select No, the system restarts.

Obtaining a License Key

A license key is required to update your system. It may be obtained by contacting SonoSite, Inc. Technical Support Department.

Technical Support	1-877-657-8118
International technical support:	Contact your local representative or call 425-951-1330
Technical Support fax:	1-425-951-6700
Technical Support e-mail:	service@sonosite.com
SonoSite website:	www.sonosite.com and select Support & Service

To receive your license key, you will need to provide the following information, which is displayed on the system information screen of your system:

Table 2: Software License Key Information

System Software	Transducer Software
Name of the person installing the upgrade	Name of the person installing the upgrade
Serial number (located on the bottom of your system)	Serial number
ARM version	REF number
PCBA serial number	SH database version

Installing a License Key

When you have obtained a license key for your software, you must enter it into the system. Once a valid license key has been entered, the system remains licensed until the next time the system software is upgraded.

- Install License Key**
- 1 Turn on the system.
If the software is not yet licensed, the license update screen displays. The license update screen displays the following information: how to contact SonoSite, the required information to obtain the license key, and the grace period (time remaining) on your system.



Figure 12 System and Transducer License Screens

- 2 Enter your license key in the **license number** field.
- 3 Select **Done** from the on-screen menu to install the license key and license your software.
 - If you have entered a valid license key and you cannot complete the licensing procedure, verify that the license key has been entered correctly.
 - If after confirming correct entry of the license key, you are still unable to license your system, call SonoSite Technical Support.

Maintenance

This section is intended to assist in effective cleaning and disinfection. It is also intended to protect the system and transducers against damage during cleaning or disinfection.

- Use the recommendations in this section when cleaning or disinfecting your ultrasound system, transducer, and accessories.
- Use the cleaning recommendations in the peripheral manufacturer's instructions when cleaning or disinfecting your peripherals.
- For more information about cleaning or disinfection solutions or ultrasound gels used with the transducer, contact SonoSite or your local representative. For information about a specific product, contact the product manufacturer.
- There is no recommended periodic or preventive maintenance required for the system, transducer, or accessories other than cleaning and disinfecting the transducer after every use. See ["Cleaning and Disinfecting Transducers"](#) on page 188. There are no internal adjustments or alignments that require periodic testing or calibration. All maintenance requirements are described in this chapter and in the *MicroMaxx Ultrasound System Service Manual*. Performing maintenance activities not described in the user guide or Service Manual may void the product warranty.
- Contact SonoSite Technical Support for any maintenance questions.

Recommended Disinfectant

See the [Table 3, "Disinfectants Compatible with System and Transducers"](#) on page 193. See the SonoSite website for updated cleaning and disinfectant information: www.sonosite.com

Safety

Please observe the following warnings and cautions when using cleaners, disinfectants, and gels. More specific warnings and cautions are included in the product literature and in the procedures later in this chapter.

WARNING:	<p>Disinfectants and cleaning methods listed are recommended by SonoSite for compatibility with product materials, not for biological effectiveness. Refer to the disinfectant label instructions for guidance on disinfection efficacy and appropriate clinical uses.</p> <p>The level of disinfection required for a device is dictated by the type of tissue it will contact during use. To avoid infection, ensure the disinfectant type is appropriate for the equipment. For information, see the disinfectant label instructions and the recommendations of the Association for Professionals in Infection Control and Epidemiology (APIC) and the U.S. Food and Drug Administration (FDA).</p> <p>To prevent contamination, the use of sterile transducer sheaths and sterile coupling gel is recommended for clinical applications of an invasive or surgical nature. Do not apply the transducer sheath and gel until you are ready to perform the procedure.</p>
-----------------	---

Caution: Some transducer sheaths contain natural rubber latex and talc, which can cause allergic reactions in some individuals. Refer to 21 CFR 801.437, User labeling for devices that contain natural rubber.

Cleaning and Disinfecting Ultrasound System

The exterior surface of the ultrasound system and the accessories can be cleaned and disinfected using a recommended cleaner or disinfectant.

WARNING: To avoid electrical shock, before cleaning, disconnect the system from the power supply or remove from the mini-dock or docking system.

To avoid infection always use protective eyewear and gloves when performing cleaning and disinfecting procedures.

To avoid infection, if a pre-mixed disinfection solution is used, observe the solution expiration date, and ensure that the date has not passed.

To avoid infection, the level of disinfection required for a product is dictated by the type of tissue it contacts during use. Ensure the solution strength and duration of contact are appropriate for the equipment. For information, see the disinfectant label instructions and the recommendations of the Association for Professionals in Infection Control and Epidemiology (APIC) and FDA.

Caution: Do not spray cleaners or disinfectant directly on the system surfaces. Doing so may cause solution to leak into the system, damaging the system and voiding the warranty.

Do not use strong solvents such as thinner or benzene, or abrasive cleansers, since these will damage the exterior surfaces.

Use only recommended cleaners or disinfectants on system surfaces. Immersion-type disinfectants are not tested for use on system surfaces.

When you clean the system, ensure the solution does not get inside the system keys or the battery compartment.

Do not scratch the LCD screen.

Clean LCD Screen Dampen a clean, non-abrasive, cotton cloth with an ammonia-based window cleaner, and wipe the screen clean. It is recommended to apply the cleaning solution to the cloth rather than the surface of the screen.

**Clean and
Disinfect
System
Surfaces**

- 1 Turn off the system.
- 2 Disconnect the system from the power supply or remove from the mini-dock or docking system.
- 3 Clean the exterior surfaces using a soft cloth lightly dampened in a mild soap or detergent cleaning solution to remove any particulate matter or body fluids. Apply the solution to the cloth rather than the surface.
- 4 Mix the disinfectant solution compatible with the system, following disinfectant label instructions for solution strengths and disinfectant contact duration.
- 5 Wipe surfaces with the disinfectant solution.
- 6 Air dry or towel dry with a clean cloth.

Cleaning and Disinfecting Transducers

To disinfect the transducer, use the immersion method or the wipe method. Immersible transducers can be disinfected only if the product labeling indicates they can be used with an immersion method. See [Table 3, “Disinfectants Compatible with System and Transducers” on page 193](#).

WARNING:

To avoid electrical shock, before cleaning, disconnect the transducer from the system.

To avoid injury, always use protective eyewear and gloves when performing cleaning and disinfecting procedures.

To avoid infection, if a pre-mixed disinfection solution is used, observe the solution expiration date, and ensure that the date has not passed.

To avoid infection, the level of disinfection required for a transducer is dictated by the type of tissue it contacts during use. Ensure the solution strength and duration of contact are appropriate for the equipment. SonoSite tests products for compatibility of materials only. SonoSite does not test for biological effectiveness. For information, see the disinfectant label instructions and the recommendations of the Association for Professionals in Infection Control and Epidemiology (APIC) and FDA.

Caution:

Transducers must be cleaned after every use. Cleaning transducers is necessary prior to effective disinfection. Ensure you follow the manufacturer's instructions when using disinfectants.

Do not use a surgeon's brush when cleaning transducers. Even the use of soft brushes can damage a transducer. Use a soft cloth.

Using a non-recommended cleaning or disinfection solution, incorrect solution strength, or immersing a transducer deeper or for a longer period of time than recommended can damage or discolor the transducer and void the transducer warranty.

Caution

Do not allow cleaning solution or disinfectant into the transducer connector.

Do not allow disinfectant to contact metal surfaces. Use a soft cloth lightly dampened in a mild soap or compatible cleaning solution to remove any disinfectant that remains on metal surfaces.

Clean and Disinfect Transducer Using Wipe Method

- 1 Disconnect the transducer from the system.
- 2 Remove any transducer sheath.
- 3 Clean the surface using a soft cloth lightly dampened in a mild soap or detergent cleaning solution to remove any particulate matter or body fluids. Apply the solution to the cloth rather than the surface.
- 4 Rinse with water or wipe with water-dampened cloth, then wipe with a dry cloth.
- 5 Mix the disinfectant solution compatible with the transducer, following disinfectant label instructions for solution strengths and disinfectant contact duration.
- 6 Wipe surfaces with the disinfectant solution.
- 7 Air dry or towel dry with a clean cloth.
- 8 Examine the transducer and cable for damage such as cracks, splitting, or fluid leaks.
If damage is evident, discontinue use of the transducer, and contact SonoSite or your local representative.

Clean and Disinfect Transducer Using Immersion Method	<ol style="list-style-type: none"> 1 Disconnect the transducer from the system. 2 Remove any transducer sheath. 3 Clean the surface using a soft cloth lightly dampened in a mild soap or compatible cleaning solution to remove any particulate matter or body fluids. Apply the solution to the cloth rather than the surface. 4 Rinse with water or a wipe with water-dampened cloth, then wipe with a dry cloth. 5 Mix the disinfectant solution compatible with the transducer, following disinfectant label instructions for solution strengths and disinfectant contact duration. 6 Immerse the transducer into the disinfection solution not more than 12-18 inches (31-46 cm) from the point where the cable enters the transducer. Follow the instructions on the disinfectant label for the duration of the transducer immersion. 7 Using the instructions on the disinfectant label, rinse to the point of the previous immersion, and then air dry or towel dry with a clean cloth. 8 Examine the transducer and cable for damage such as cracks, splitting, or fluid leaks. If damage is evident, discontinue use of the transducer, and contact SonoSite or your local representative.
--	---

Sterilizing Transducers

Surgical transducers can be sterilized using STERIS® SYSTEM 1® or STERRAD®. See the *Surgical Transducer User Guide* and the *LAP Transducer User Guide* for more information.

Cleaning and Disinfecting Transducer Cables

The transducer cable can be disinfected using a recommended wipe or immersion disinfectant. Before disinfecting, orient the cable to ensure that the transducer and system do not get immersed.

WARNING: To avoid infection, if a pre-mixed disinfection solution is used, observe the solution expiration date, and ensure that the date has not passed.

Caution: Attempting to disinfect a transducer cable using a method other than the one included here can damage the transducer and void the warranty.

Clean and Disinfect Transducer Cable Using Wipe Method

- 1 Disconnect the transducer from the system.
 - 2 Remove any transducer sheath.
 - 3 Clean the transducer cable using a soft cloth lightly dampened in a mild soap or detergent cleaning solution to remove any particulate matter or body fluids. Apply the solution to the cloth rather than the surface.
 - 4 Rinse with water or wipe with water-dampened cloth, then wipe with a dry cloth.
 - 5 Mix the disinfectant solution compatible with the transducer cable, following disinfectant label instructions for solution strengths and disinfectant contact duration.
 - 6 Wipe surfaces with the disinfectant solution.
 - 7 Air dry or towel dry with a clean cloth.
 - 8 Examine the transducer and cable for damage such as cracks, splitting, or fluid leaks.
If damage is evident, discontinue use of the transducer, and contact SonoSite or your local representative.
-

Clean and Disinfect Transducer Cable Using Immersion Method

- 1 Disconnect the transducer from the system.
- 2 Remove any transducer sheath.
- 3 Clean the transducer cable using a soft cloth lightly dampened in a mild soap or compatible cleaning solution to remove any particulate matter or body fluids. Apply the solution to the cloth rather than the surface.
- 4 Rinse with water or a wipe with water-dampened cloth, then wipe with a dry cloth.
- 5 Mix the disinfectant solution compatible with the transducer cable, following disinfectant label instructions for solution strengths and disinfectant contact duration.
- 6 Immerse the transducer cable into the disinfection solution. Follow the instructions on the disinfectant label for the duration of the transducer cable immersion.
- 7 Using the instructions on the disinfectant label, rinse the transducer cable, and then air dry or towel dry with a clean cloth.
- 8 Examine the transducer and cable for damage such as cracks, splitting, or fluid leaks.
If damage is evident, discontinue use of the transducer, and contact SonoSite or your local representative.

Cleaning and Disinfecting Battery

Caution: To avoid damaging the battery, do not allow cleaning solution or disinfectant to come in contact with the battery terminals.

- Clean and Disinfect Battery Using Wipe Method**
- 1 Remove the battery from the system.
 - 2 Clean the surface using a soft cloth lightly dampened in a mild soap or detergent cleaning solution.
Apply the solution to the cloth rather than the surface.
 - 3 Wipe the surfaces with the disinfection solution. Theracide disinfectant is recommended.
 - 4 Air dry or towel dry with a clean cloth.

Cleaning Footswitch

Caution: To avoid damaging the footswitch, do not sterilize. It is not intended for use in a sterile environment.

- Clean Footswitch**
- 1 Dampen a non-abrasive cloth with one of the following products:
 - Isopropyl alcohol
 - Soap and water
 - Cidex
 - Sodium Hypochlorite 5.25% (Bleach) diluted 10:1
 - 2 Wring out cloth until slightly wet and then gently rub soiled area until clean.

Cleaning and Disinfecting ECG Cables

Caution: To avoid damaging the ECG cable, do not sterilize.

- Clean and Disinfect ECG Cable Using Wipe Method**
- 1 Remove the cable from the system.
 - 2 Clean the surface using a soft cloth lightly dampened in a mild soap or detergent cleaning solution.
Apply the solution to the cloth rather than the surface.
 - 3 Wipe the surfaces with the following products:
 - Bleach (sodium hypochlorite)
 - Cidex disinfectants
 - Green soap
 - Theracide
 - 4 Air dry or towel dry with a clean cloth.

See the SonoSite website for updated cleaning and disinfectant information:
www.sonosite.com. Select Quick Link and then Documentation.

Table 3: Disinfectants Compatible with System and Transducers

Disinfection and Cleaning Solutions	Country of Origin	Type	Active Ingredient	C60e/ICT/ L38e/P10/ P17/SLA	D2	HFL38	SLT	C11e/ L25e	System Surfaces
AbcoCide 14 (4)	USA	Liquid	Gluteraldehyde	A	U	A	A	A	A
Accel Wipes	CAN	Wipe	Hydrogen Peroxide	A	U	A	A	A	A
Accel Plus	CAN	Wipe	Hydrogen Peroxide	N	U	N	N	N	N
Accel TB	CAN	Wipe	Hydrogen Peroxide	N	U	N	N	N	N
Aidal Plus	AUS	Liquid	Gluteraldehyde	A	U	A	A	A	N
Alkacide	FRA	Liquid	Gluteraldehyde	A	U	A	A	A	A
Alkazyme	FRA	Liquid	Quat. Ammonia	A	U	A	A	A	A
Aquatabs (1000)	IRL	Tablet	Sodium Dichloroisocyanurate	A	U	N	A	A	A
Aquatabs (2000)	IRL	Tablet	Sodium Dichloroisocyanurate	A	U	N	A	A	N
Aquatabs (5000)	IRL	Tablet	Sodium Dichloroisocyanurate	N	U	N	N	N	N
Anioxyde 1000	FRA	Liquid	Peracetic Acid	N	U	N	N	N	N
Ascend (4)	USA	Liquid	Quat Ammonia	A	U	A	A	A	A
Asepti-HB	USA	Liquid	Quat Ammonia	A	U	A	A	A	N
Asepti-Steryl	USA	Spray	Ethanol	A	U	A	A	A	N
Asepti-Wipes	USA	Wipe	Propanol (Isopropyl Alcohol)	A	U	A	A	A	A

Table 3: Disinfectants Compatible with System and Transducers (Continued)

Disinfection and Cleaning Solutions	Country of Origin	Type	Active Ingredient	C60e/ICT/ L38e/P10/ P17/SLA	D2	HFL38	SLT	C11e/ L25e	System Surfaces
Bacillocid rasant	DEU	Liquid	Glut./Quat. Ammonia	A	U	A	A	A	N
Banicide (4)	USA	Liquid	Gluteraldehyde	A	U	U	A	A	N
Betadine	USA	Liquid	Providone-Iodine	N	U	N	N	A	N
Bleach (4)	USA	Liquid	NaCl Hypochlorite	A	U	A	A	A	N
Cavicide (4)	USA	Liquid	Isopropyl	A	U	A	A	A	A
Caviwipes	USA	Wipes	Isopropanol	A	U	A	A	N	A
Chlor-Clean	GBR	Liquid	Sodium Dichloroisocyanurate	A	U	N	A	A	N
Cidex 14 (2) (4) (5)	USA	Liquid	Gluteraldehyde	A	U	A	A	A	A
Cidex OPA (2) (3) (4) (5)	USA	Liquid	Ortho-phthaldehyde	A	A	A	A	A	A
Cidex Plus (2) (4) (5)	USA	Liquid	Gluteraldehyde	A	U	A	A	A	A
Clorox Wipes	USA	Wipes	Isopropanol	A	U	A	A	A	N
Control III (4)	USA	Liquid	Quat. Ammonia	A	U	A	A	N	A
Coverage Spray (4)	USA	Spray	Quat. Ammonia	A	U	A	A	N	N
DentaSept	FRA	Liquid	Quat. Ammonia	N	U	N	A	N	N
Dentured Alcohol	USA	Liquid	Ethanol	N	U	N	N	N	N
DisCide Wipes	USA	Wipes	Isopropyl Alcohol	A	U	A	A	A	N
DisOPA	JPN	Liquid	Ortho-phthaldehyde	A	A	A	A	A	N
Dispatch (4)	USA	Spray	NaCl Hypochlorite	A	A	A	A	A	N

Table 3: Disinfectants Compatible with System and Transducers (Continued)

Disinfection and Cleaning Solutions	Country of Origin	Type	Active Ingredient	C60e/ICT/ L38e/P10/ P17/SLA	D2	HFL38	SLT	C11e/ L25e	System Surfaces
End-Bac II	USA	Liquid	Quat. Ammonia	A	U	A	A	A	A
Endozime AW Plus	FRA	Liquid	Propanol	A	U	A	A	A	A
Envirocide (4)	USA	Liquid	Isopropyl	A	U	U	A	N	A
Enzol	USA	Cleaner	Ethylene Glycol	A	U	A	A	A	N
Expose	USA	Liquid	Isopropyl	A	U	A	A	A	A
Gigasept AF (3)	DEU	Liquid	Quat. Ammonia	A	U	A	A	A	N
Gigasept FF	DEU	Liquid	Bersteinsäure	N	U	N	A	N	N
Gluteraldehyde SDS	USA	Liquid	Gluteraldehyde	A	U	U	A	A	A
Hexanios	FRA	Liquid	Polyhexanide/Quat. Ammonia	A	U	A	A	A	A
Hi Tor Plus	USA	Liquid	Chloride	A	U	A	A	N	N
Hibiclens	USA	Cleaner	Chlorhexidine	A	U	A	A	A	A
Hydrogen Peroxide	USA	Liquid	Hydrogen Peroxide	A	A	A	A	A	N
Isopropanol Alcohol	ALL	Liquid	Alcohol	N	U	N	N	N	N
Kodan Tücher	DEU	Liquid	Propanol	A	U	A	A	A	N
Kohrsolin ff	DEU	Liquid	Gluteraldehyde	A	U	U	A	A	N
Korsolex basic (3)	DEU	Liquid	Gluteraldehyde	N	U	N	A	N	A
LpHse (4)	USA	Liquid	O-phenylphenol	A	U	A	A	A	A
Lysol	USA	Spray	Ethanol	N	U	N	N	N	N
Lysol IC (4)	USA	Liquid	O-phenylphenol	A	U	N	A	A	A

Table 3: Disinfectants Compatible with System and Transducers (Continued)

Disinfection and Cleaning Solutions	Country of Origin	Type	Active Ingredient	C60e/ICT/ L38e/P10/ P17/SLA	D2	HFL38	SLT	C11e/ L25e	System Surfaces
Madacide (4)	USA	Liquid	Isopropanol	A	N	A	A	N	N
Matar (4)	USA	Liquid	O-phenylphenol	A	U	U	A	A	N
MetriCide 14 (2) (4) (5)	USA	Liquid	Gluteraldehyde	A	U	A	A	A	A
MetriCide 28 (2) (4) (5)	USA	Liquid	Gluteraldehyde	A	U	A	A	A	A
MetriZyme	USA	Cleaner	Propylene Glycol	A	U	A	A	A	A
Mikrobak forte	DEU	Liquid	Ammonium Chloride	A	U	A	A	A	A
Mikrozid Wipes (3)	DEU	Wipe	Ethanol/Propanol	A	U	A	A	A	A
Nuclear	FRA	Spray	Alcohol/Biguanide	A	U	A	A	A	N
Precise (4)	USA	Spray	O-phenylphenol	N	U	N	N	N	N
Ruthless	USA	Spray	Quat. Ammonia	A	U	A	A	N	A
Sagrosept Wipe	DEU	Wipe	Propanol	A	U	A	A	A	N
Salvanios pH 7	FRA	Liquid	Quat. Ammonia	A	U	A	A	A	A
Sani-Cloth HB	USA	Wipe	Quat. Ammonia	A	U	A	A	N	N
Sani-Cloth Plus	USA	Wipe	Quat. Ammonia	A	U	A	A	A	N
Sklar (4)	USA	Liquid	Isopropanol	A	U	A	A	N	N
Sporicidin (2) (4)	USA	Liquid	Phenol	A	N	A	A	A	N
Sporicidin Wipes (2) (4)	USA	Wipe	Phenol	A	U	A	A	A	N

Table 3: Disinfectants Compatible with System and Transducers (Continued)

Disinfection and Cleaning Solutions	Country of Origin	Type	Active Ingredient	C60e/ICT/ L38e/P10/ P17/SLA	D2	HFL38	SLT	C11e/ L25e	System Surfaces
Staphene (4)	USA	Spray	Ethanol	A	U	N	A	A	N
Steranios	FRA	Liquid	Gluteraldehyde	A	U	A	A	A	A
Super Sani-Cloth	USA	Wipe	Isopropyl Alcohol	N	U	N	A	N	N
T-Spray	USA	Spray	Quat. Ammonia	A	U	A	A	N	N
T-Spray II	USA	Spray	Alkyl/Chloride	A	U	A	A	A	A
TASK 105	USA	Spray	Quat. Ammonia	A	U	A	A	A	A
TBQ (4)	USA	Liquid	Alkyl	A	U	A	A	A	N
Theracide Plus	USA	Liquid	Quat. Ammonia	A	U	A	A	A	N
Theracide Plus Wipes	USA	Wipe	Quat. Ammonia	A	U	A	N	A	A
Tor (4)	USA	Liquid	Quat. Ammonia	A	U	A	A	N	N
Transeptic	USA	Cleaner	Alcohol	N	U	N	N	N	N
Tristel	GBR	Liquid	Chlorine Dioxide	A	A	A	A	A	A
Tristel Wipes	GBR	Wipe	Chlorine Dioxide	N	A	N	A	N	A
Vesphene II (4)	USA	Liquid	Sodium/ o-Phenylphenate	A	U	A	A	A	A
Virex II 256	USA	Liquid	Ammonium Chloride	A	U	A	A	A	N
Virex TB (4)	USA	Liquid	Quat. Ammonia	A	U	A	A	N	N
Wavicide -01 (2) (4) (5)	USA	Liquid	Gluteraldehyde	N	U	N	N	N	N

Table 3: Disinfectants Compatible with System and Transducers (Continued)

Disinfection and Cleaning Solutions	Country of Origin	Type	Active Ingredient	C60e/ICT/ L38e/P10/ P17/SLA	D2	HFL38	SLT	C11e/ L25e	System Surfaces
Wavicide -06 (4)	USA	Liquid	Gluteraldehyde	A	U	A	A	A	N
Wex-Cide (4)	USA	Liquid	O-phenylphenol	A	U	A	A	A	A

(1) Compatible but no EPA Registration

(2) Has FDA 510(k)

(3) Has CE Mark

(4) EPA Registered

(5) FDA 510(k) cleared liquid sterilant or high level disinfectant



A = Acceptable for use with system or transducer/cable.

N = No (do not use)

U = Untested (do not use)

Caution: To avoid damaging the transducer, follow the disinfectant manufacturer's instructions. Soaking times exceeding values in the table below and/or inadequate rinsing may reduce transducer life time or cause damages. See the *TEE Transducer User Guide* for important transducer care and cleaning instructions.

Table 4: Disinfectants Compatible with TEE Transducers

Disinfectant	Active Ingredient	TEE	 
PeraSafe	Sodium Perborate	OK	<15 minutes
Cidex	Glutaraldehyde	OK	<50 minutes
Cidex OPA	Ortho-phthalaldehyde	OK	<15 minutes
Cidex Plus	Glutaraldehyde	OK	<25 minutes
Cidezyme/Enzol	Enzymatic detergent	OK	<10 minutes
Klenzyme	Enzymatic detergent	OK	<15 minutes
Metricide	Glutaraldehyde	OK	<50 minutes
Wavicide-01	Glutaraldehyde	OK	<50 minutes
STERIS System 1	Peracetic acid	⊘	
STERRAD	Hydrogen peroxide gas plasma	⊘	

Chapter 7: References

This section includes information about clinical measurements that can be made with the system, the accuracy of each measurement, and factors affecting measurement accuracy.

Display Size

The precision with which a caliper can be placed in an image can be improved by making sure the area of interest fills as much of the screen as possible.

In 2D imaging, the distance measurement is improved by minimizing the display depth.

Caliper Placement

When making a measurement, accurate placement of the caliper is essential.

To improve caliper placement precision: adjust the display for maximum sharpness; use leading edges (closest to the transducer) or borders for start and stop points; and maintain a consistent transducer orientation for each type of measurement.

When the calipers are positioned farther apart, they get larger. When the calipers are moved closer together, they get smaller. The caliper line disappears as the calipers get closer together.

2D Measurements

The measurements provided by the system do not define a specific physiological or anatomical parameter. Rather, what is provided is a measurement of a physical property such as distance for evaluation by the clinician. The accuracy values require that you can place the calipers over one pixel. The values do not include acoustic anomalies of the body.

The 2D linear distance measurement results are displayed in centimeters with one place past the decimal point, if the measurement is ten or greater; two places past the decimal point, if the measurement is less than ten.

The linear distance measurement components have the accuracy and range shown in the following tables.

Table 1: 2D Measurement Accuracy and Range

2D Measure Accuracy and Range	System Tolerance ^a	Accuracy By	Test Method ^b	Range (cm)
Axial Distance	< $\pm 2\%$ plus 1% of full scale	Acquisition	Phantom	0-26 cm
Lateral Distance	< $\pm 2\%$ plus 1% of full scale	Acquisition	Phantom	0-35 cm

Table 1: 2D Measurement Accuracy and Range (Continued)

2D Measure Accuracy and Range	System Tolerance^a	Accuracy By	Test Method^b	Range (cm)
Diagonal Distance	< ±2% plus 1% of full scale	Acquisition	Phantom	0-44 cm
Area ^c	< ±4% plus (2% of full scale/smallest dimension) * 100 plus 0.5%	Acquisition	Phantom	0.01-720 cm ²
Circumference ^d	< ±3% plus (1.4% of full scale/smallest dimension) * 100 plus 0.5%	Acquisition	Phantom	0.01-96 cm

a. Full scale for distance implies the maximum depth of the image.

b. An RMI 413a model phantom with 0.7 dB/cm MHz attenuation was used.

c. The area accuracy is defined using the following equation:

$$\% \text{ tolerance} = ((1 + \text{lateral error}) * (1 + \text{axial error}) - 1) * 100 + 0.5\%.$$

d. The circumference accuracy is defined as the greater of the lateral or axial accuracy and by the following equation:

$$\% \text{ tolerance} = (\sqrt{2} (\text{maximum of 2 errors}) * 100) + 0.5\%.$$

Table 2: M Mode Measurement and Calculation Accuracy and Range

M Mode Measurement Accuracy and Range	System Tolerance	Accuracy By	Test Method	Range
Distance	< +/- 2% plus 1% of full scale ^a	Acquisition	Phantom ^b	0-26 cm
Time	< +/- 2% plus 1% of full scale ^c	Acquisition	Phantom ^d	0.01-10 sec
Heart Rate	< +/- 2% plus (Full Scale ^c * Heart Rate/100) %	Acquisition	Phantom ^d	5-923 bpm

a. Full scale for distance implies the maximum depth of the image.

b. An RMI 413a model phantom with 0.7 dB/cm MHz attenuation was used.

c. Full scale for time implies the total time displayed on the scrolling graphic image.

d. SonoSite special test equipment was used.

Table 3: PW Doppler Mode Measurement and Calculation Accuracy and Range

Doppler Mode Measurement Accuracy and Range	System Tolerance	Accuracy By	Test Method ^a	Range
Velocity cursor	< +/- 2% plus 1% of full scale ^b	Acquisition	Phantom	0.01 cm/sec-550 cm/sec
Frequency cursor	< +/- 2% plus 1% of full scale ^b	Acquisition	Phantom	0.01kHz-20.8 kHz
Time	< +/- 2% plus 1% of full scale ^c	Acquisition	Phantom	0.01-10 sec

- SonoSite special test equipment was used.
- Full scale for frequency or velocity implies the total frequency or velocity magnitude, displayed on the scrolling graphic image.
- Full scale for time implies the total time displayed on the scrolling graphic image.

Sources of Measurement Errors

In general, two types of errors can be introduced into the measurement: acquisition error and algorithmic error.

Acquisition Error

Acquisition error includes errors introduced by the ultrasound system electronics relating to signal acquisition, signal conversion, and signal processing for display. Additionally, computational and display errors are introduced by the generation of the pixel scale factor, application of that factor to the caliper positions on the screen, and the measurement display.

Algorithmic Error

Algorithmic error is the error introduced by measurements, which are input to higher order calculations. This error is associated with floating-point versus integer-type math, which is subject to errors introduced by rounding versus truncating results for display of a given level of significant digit in the calculation.

Terminology and Measurement Publications

Terminology and measurements comply with AIUM published standards.

Cardiac References

Acceleration (ACC) in cm/s²

Zwiebel, W.J. *Introduction to Vascular Ultrasonography*. 4th ed., W.B. Saunders Company, (2000), 52.
ACC = abs (delta velocity/delta time)

Acceleration Time (AT) in msec

Oh, J.K., J.B. Seward, A.J. Tajik. *The Echo Manual*. 2nd ed., Lippincott, Williams, and Wilkins, (1999), 219.

Aortic Valve Area (AVA) by Continuity Equation in cm²

Reynolds, Terry. *The Echocardiographer's Pocket Reference*. 2nd ed., School of Cardiac Ultrasound, Arizona Heart Institute, (2000), 393, 442.

$$A_2 = A_1 * V_1/V_2$$

where: A_2 = Ao valve area

A_1 = LVOT area; V_1 = LVOT velocity; V_2 = Ao valve velocity

LVOT = Left Ventricular Outflow Tract

$$\text{AVA} (PV_{\text{LVOT}}/PV_{\text{AO}}) * \text{CSA}_{\text{LVOT}}$$

$$\text{AVA} (VTI_{\text{LVOT}}/VTI_{\text{AO}}) * \text{CSA}_{\text{LVOT}}$$

Body Surface Area (BSA) in m²

Grossman, W. *Cardiac Catheterization and Angiography*. Philadelphia: Lea and Febiger, (1980), 90.

$$\text{BSA} = 0.007184 * \text{Weight}^{0.425} * \text{Height}^{0.725}$$

Weight = kilograms

Height = centimeters

Cardiac Index (CI) in l/min/m²

Oh, J.K., J.B. Seward, A.J. Tajik. *The Echo Manual*. 2nd Edition, Boston: Little, Brown and Company, (1999), 59.

$$\text{CI} = \text{CO}/\text{BSA}$$

where: CO = Cardiac Output

BSA = Body Surface Area

Cardiac Output (CO) in l/min

Oh, J.K., J.B. Seward, A.J. Tajik *The Echo Manual*. 2nd ed., Lippincott, Williams, and Wilkins, (1999), 59.

$$\text{CO} = (\text{SV} * \text{HR})/1000$$

where: CO = Cardiac Output

SV = Stroke Volume

HR = Heart Rate

Cross Sectional Area (CSA) in cm²

Reynolds, Terry. *The Echocardiographer's Pocket Reference*. 2nd ed., School of Cardiac Ultrasound, Arizona Heart Institute, (2000), 383.

$$\text{CSA} = 0.785 * D^2$$

where: D = diameter of the anatomy of interest

Deceleration Time in msec

Reynolds, Terry. *The Echocardiographer's Pocket Reference*. 2nd ed., School of Cardiac Ultrasound, Arizona Heart Institute, (2000), 453.

$$|\text{time a} - \text{time b}|$$

Delta Pressure: Delta Time (dP:dT) in mmHg/s

Otto, C.M. *Textbook of Clinical Echocardiography*. 2nd ed., W.B. Saunders Company, (2000), 117, 118.
32 mmHg/time interval in seconds

E:A Ratio in cm/sec

$$\text{E:A} = \text{velocity E/velocity A}$$

E/Ea Ratio

Reynolds, Terry. *The Echocardiographer's Pocket Reference*. 2nd ed., School of Cardiac Ultrasound, Arizona Heart Institute, (2000), 225.

$$\text{E Velocity/Ea velocity}$$

where: E velocity = Mitral Valve E velocity

Ea = annular E velocity, also known as: E prime

Effective Regurgitant Orifice (ERO) in mm²

Reynolds, Terry. *The Echocardiographer's Pocket Reference*. 2nd ed., School of Cardiac Ultrasound, Arizona Heart Institute, (2000), 455.

$$\text{ERO} = 6.28 (r^2) * \text{Va/MR Vel}$$

where: r = radius

Va = aliasing velocity

Ejection Fraction (EF), percent

Oh, J.K., J.B. Seward, A.J. Tajik. *The Echo Manual*. 2nd ed., Lippincott, Williams, and Wilkins, (1999), 40.

$$\text{EF} = ((\text{LVEDV} - \text{LVESV})/\text{LVEDV}) * 100\%$$

where: EF = Ejection Fraction

LVEDV = Left Ventricular End Diastolic Volume

LVESV = Left Ventricular End Systolic Volume

Elapsed Time (ET) in msec

ET = time between velocity cursors in milliseconds

Heart Rate (HR) in bpm

HR = 3 digit value input by user or measured on M Mode and Doppler image in one heart cycle

Interventricular Septum (IVS) Fractional Thickening, percent

Laurenceau, J. L., M.C. Malergue. *The Essentials of Echocardiography*. Le Hague: Martinus Nijhoff, (1981), 71.

$$\text{IVSFT} = ((\text{IVSS} - \text{IVSD})/\text{IVSD}) * 100\%$$

where: IVSS = Interventricular Septal Thickness at Systole
 IVSD = Interventricular Septal Thickness at Diastole

Isovolumic Relaxation Time (IVRT) in msec

Reynolds, Terry. *The Echocardiographer's Pocket Reference*. School of Cardiac Ultrasound, Arizona Heart Institute, (1993), 146.

|time a - time b|

Left Atrium/Aorta (LA/Ao)

Feigenbaum, H. *Echocardiography*. Philadelphia: Lea and Febiger, (1994), 206, Figure 4-49.

Left Ventricular End Volumes (Teichholz) in ml

Teichholz, L.E., T. Kreulen, M.V. Herman, et. al. "Problems in echocardiographic volume determinations: echocardiographic-angiographic correlations in the presence or absence of asynergy." *American Journal of Cardiology*, (1976), 37:7.

$$\text{LVESV} = (7.0 * \text{LVDS}^3)/(\text{2.4} + \text{LVDS})$$

where: LVESV = Left Ventricular End Systolic Volume
 LVDS = Left Ventricular Dimension at Systole

$$\text{LVEDV} = (7.0 * \text{LVDD}^3)/(\text{2.4} + \text{LVDD})$$

where: LVEDV = Left Ventricular End Diastolic Volume
 LVDD = Left Ventricular Dimension at Diastole

Left Ventricular Mass in gm

Oh, J.K., J.B. Seward, A.J. Tajik. *The Echo Manual*. 2nd Edition, Boston: Little, Brown and Company, (1999), 39.

$$\text{LV Mass} = 1.04 [(\text{LVID} + \text{PWT} + \text{IVST})^3 - \text{LVID}^3] * 0.8 + 0.6$$

where: LVID = Internal Dimension
 PWT = Posterior Wall Thickness
 IVST = Interventricular Septal Thickness
 1.04 = Specific gravity of the myocardium
 0.8 = Correction factor

Left Ventricular Volume: Biplane Method in ml

Schiller, N.B., P.M. Shah, M. Crawford, et.al. "Recommendations for Quantitation of the Left Ventricle by Two-Dimensional Echocardiography." *Journal of American Society of Echocardiography*. September-October 1989, 2:362.

$$V = \left(\frac{\pi}{4}\right) \sum_{i=1}^n a_i b_i \left(\frac{L}{n}\right)$$

where: V = Volume in ml
 a = Diameter
 b = Diameter
 n = Number of segments (n=20)
 L = Length
 i = Segment

Left Ventricular Volume: Single Plane Method in ml

Schiller, N.B., P.M. Shah, M. Crawford, et.al. "Recommendations for Quantitation of the Left Ventricle by Two-Dimensional Echocardiography." *Journal of American Society of Echocardiography*. September-October 1989, 2:362.

$$V = \left(\frac{\pi}{4}\right) \sum_{i=1}^n a_i^2 \left(\frac{L}{n}\right)$$

where: V = Volume
 a = Diameter
 n = Number of segments (n=20)
 L = Length
 i = Segment

Left Ventricular Dimension (LVD) Fractional Shortening, percent

Oh, J.K., J.B. Seward, A.J. Tajik. *The Echo Manual*. Boston: Little, Brown and Company, (1994), 43-44.

$$\text{LVDFS} = ((\text{LVDD} - \text{LVDS})/\text{LVDD}) * 100\%$$

where: LVDD = Left Ventricle Dimension at Diastole
 LVDS = Left Ventricle Dimension at Systole

Left Ventricular Posterior Wall Fractional Thickening (LVPWFT), percent

Laurenceau, J. L., M.C. Malergue. *The Essentials of Echocardiography*. Le Hague: Martinus Nijhoff, (1981), 71.

$$\text{LVPWFT} = ((\text{LVPWS} - \text{LVPWD})/\text{LVPWD}) * 100\%$$

where: LVPWS = Left Ventricular Posterior Wall Thickness at Systole
 LVPWD = Left Ventricular Posterior Wall Thickness at Diastole

Mean Velocity (Vmean) in cm/s

Vmean = mean velocity

Mitral Valve Area (MVA) in cm²

Reynolds, Terry. *The Echocardiographer's Pocket Reference*. 2nd ed., School of Cardiac Ultrasound, Arizona Heart Institute, (2000), 391, 452.

$$MVA = 220/PHT$$

where: PHT = pressure half time

Note: 220 is an empirical derived constant and may not accurately predict mitral valve area in mitral prosthetic heart valves. The mitral valve area continuity equation may be utilized in mitral prosthetic heart valves to predict effective orifice area.

MV Flow Rate in cc/sec

Reynolds, Terry. *The Echocardiographer's Pocket Reference*. 2nd ed., School of Cardiac Ultrasound, Arizona Heart Institute, (2000), 396.

$$\text{Flow} = 6.28 (r^2) * Va$$

where: r = radius

Va = aliasing Velocity

Pressure Gradient (PGr) in mmHG

Oh, J.K., J.B. Seward, A.J. Tajik. *The Echo Manual*. 2nd ed., Lippincott, Williams, and Wilkins, (1999), 64.

$$PGr = 4 * (\text{Velocity})^2$$

Peak E Pressure Gradient (E PG)

$$E PG = 4 * PE^2$$

Peak A Pressure Gradient (A PG)

$$A PG = 4 * PA^2$$

Peak Pressure Gradient (PGmax)

$$PGmax = 4 * PV^2$$

Mean Pressure Gradient (PGmean)

PGmean = Average of pressure gradients/Duration of flow

Pressure Half Time (PHT) in msec

Reynolds, Terry. *The Echocardiographer's Pocket Reference*. 2nd ed., School of Cardiac Ultrasound, Arizona Heart Institute, (2000), 391.

$$PHT = DT * 0.29$$

where: DT = deceleration time

Proximal Isovelocity Surface Area (PISA) in cm²

Oh, J.K., J.B. Seward, A.J. Tajik. *The Echo Manual*. 2nd ed., Boston: Little, Brown and Company, (1999), 125.

$$\text{PISA} = 2\pi r^2$$

where: $2\pi = 6.28$
 $r =$ aliasing radius

Qp/Qs

Reynolds, Terry. *The Echocardiographer's Pocket Reference*. 2nd ed., School of Cardiac Ultrasound, Arizona Heart Institute, (2000), 400.

$$\text{Qp/Qs} = \text{SV Qp site} / \text{SV Qs site}$$

SV sites will vary depending upon the location of the shunt.

Regurgitant Fraction (RF) in percent

Oh, J.K., J.B. Seward, A.J. Tajik. *The Echo Manual*. Boston: Little, Brown and Company, (1999), 125.

$$\text{RF} = \text{RV} / \text{MV SV}$$

where: $\text{RV} =$ Regurgitant Volume
 $\text{MV SV} =$ Mitral Stroke Volume

Regurgitant Volume (RV) in cc

Reynolds, Terry. *The Echocardiographer's Pocket Reference*. School of Cardiac Ultrasound, Arizona Heart Institute, (2000), 396, 455.

$$\text{RV} = \text{ERO} * \text{MR VTI}$$

Right Ventricular Systolic Pressure (RVSP) in mmHg

Reynolds, Terry. *The Echocardiographer's Pocket Reference*. School of Cardiac Ultrasound, Arizona Heart Institute, (1993), 152.

$$\text{RVSP} = 4 * (\text{Vmax TR})^2 + \text{RAP}$$

where: $\text{RAP} =$ Right Atrial Pressure

Stroke Index (SI) in cc/m²

Mosby's Medical, Nursing, & Allied Health Dictionary, 4th ed., (1994), 1492.

$$\text{SI} = \text{SV} / \text{BSA}$$

where: $\text{SV} =$ Stroke Volume
 $\text{BSA} =$ Body Surface Area

Stroke Volume (SV) Doppler in ml

Oh, J.K., J.B. Seward, A.J. Tajik. *The Echo Manual*. 2nd ed., Lippincott, Williams, and Wilkins, (1999), 40, 59, 62.

$$SV = (CSA * VTI)$$

where CSA = Cross Sectional Area of the orifice (LVOT area)
VTI = Velocity Time Integral of the aortic valve

Stroke Volume (SV) 2D and M Mode in ml

Oh, J.K., J.B. Seward, A.J. Tajik. *The Echo Manual*. 2nd ed., Boston: Little, Brown and Company, (1994), 44.

$$SV = (LVEDV - LVESV)$$

where: SV = Stroke Volume
LVEDV = End Diastolic Volume
LVESV = End Systolic Volume

Velocity Time Integral (VTI) in cm

Reynolds, Terry. *The Echocardiographer's Pocket Reference*. 2nd ed., School of Cardiac Ultrasound, Arizona Heart Institute, (2000), 383.

VTI = sum of abs (velocities [n])

where: Auto Trace – distance (cm) blood travels with each ejection period. Velocities are absolute values.

Obstetrical References

Amniotic Fluid Index (AFI)

Jeng, C. J., et al. "Amniotic Fluid Index Measurement with the Four Quadrant Technique During Pregnancy." *The Journal of Reproductive Medicine*, 35:7 (July 1990), 674-677.

Average Ultrasound Age (AUA)

The system provides an AUA derived from the component measurements from the measurement tables.

Estimated Date of Delivery (EDD) by Average Ultrasound Age (AUA)

Results are displayed as month/day/year.

$$EDD = \text{system date} + (280 \text{ days} - \text{AUA in days})$$

Estimated Date of Delivery (EDD) by Last Menstrual Period (LMP)

The date entered into the patient information for LMP must precede the current date.

Results are displayed as month/day/year.

$$EDD = \text{LMP date} + 280 \text{ days}$$

Estimated Fetal Weight (EFW)

Hadlock, F., et al. "Estimation of Fetal Weight with the Use of Head, Body, and Femur Measurements, A Prospective Study." *American Journal of Obstetrics and Gynecology*, 151:3 (February 1, 1985), 333-337.

Hansmann, M., et al. *Ultrasound Diagnosis in Obstetrics and Gynecology*. New York: Springer-Verlag, (1986), 154.

Osaka University. *Ultrasound in Obstetrics and Gynecology*. (July 20, 1990), 103-105.

Shepard M.J., V. A. Richards, R. L. Berkowitz, et al. "An Evaluation of Two Equations for Predicting Fetal Weight by Ultrasound." *American Journal of Obstetrics and Gynecology*, 142:1 (January 1, 1982), 47-54.

University of Tokyo, Shinozuka, N. FJSUM, et al. "Standard Values of Ultrasonographic Fetal Biometry." *Japanese Journal of Medical Ultrasonics*, 23:12 (1996), 880, Equation 1.

Gestational Age (GA) by Last Menstrual Period (LMP)

The gestational age derived from the LMP date entered on the patient information form.

Results are displayed in weeks and days, and is calculated as follows:

$GA(LMP) = \text{System date} - \text{LMP date}$

Gestational Age (GA) by Last Menstrual Period (LMPd) Derived from Established Due Date (Estab. DD)

Same as GA by Estab. DD.

The gestational age derived from the system derived LMP using the Established Due Date entered on the patient information form.

Results are displayed in weeks and days, and is calculated as follows:

$GA(LMPd) = \text{System Date} - \text{LMPd}$

Last Menstrual Period Derived (LMPd) by Established Due Date (Estab. DD)

Results are displayed as month/day/year.

$LMPd(\text{Estab. DD}) = \text{Estab. DD} - 280 \text{ days}$

Gestational Age Tables

Abdominal Circumference (AC)

Hadlock, F., et al. "Estimating Fetal Age: Computer-Assisted Analysis of Multiple Fetal Growth Parameters." *Radiology*, 152: (1984), 497-501.

Hansmann, M., et al. *Ultrasound Diagnosis in Obstetrics and Gynecology*. New York: Springer-Verlag, (1986), 431.

University of Tokyo, Shinozuka, N. FJSUM, et al. "Standard Values of Ultrasonographic Fetal Biometry." *Japanese Journal of Medical Ultrasonics*, 23:12 (1996), 885.

WARNING: The gestational age calculated by your SonoSite system does not match the age in the aforementioned reference at the 20.0 cm and 30.0 cm abdominal circumference (AC) measurements. The implemented algorithm extrapolates the gestational age from the slope of the curve of all table measurements, rather than decreasing the gestational age for a larger AC measurement indicated in the referenced table. This results in the gestational age always increasing with an increase in AC.

Anteroposterior Trunk Diameter (APTD)

University of Tokyo, Shinozuka, N. FJSUM, et al. "Standard Values of Ultrasonographic Fetal Biometry." *Japanese Journal of Medical Ultrasonics*, 23:12 (1996), 885.

Biparietal Diameter (BPD)

Chitty, L. S. and D.G. Altman. "New charts for ultrasound dating of pregnancy." *Ultrasound in Obstetrics and Gynecology* 10: (1997), 174-179, Table 3.

Hadlock, F., et al. "Estimating Fetal Age: Computer-Assisted Analysis of Multiple Fetal Growth Parameters." *Radiology*, 152: (1984), 497-501.

Hansmann, M., et al. *Ultrasound Diagnosis in Obstetrics and Gynecology*. New York: Springer-Verlag, (1986), 440.

Osaka University. *Ultrasound in Obstetrics and Gynecology*. (July 20, 1990), 98.

University of Tokyo, Shinozuka, N. FJSUM, et al. "Standard Values of Ultrasonographic Fetal Biometry." *Japanese Journal of Medical Ultrasonics*, 23:12 (1996), 885.

Crown Rump Length (CRL)

Hadlock, F., et al. "Fetal Crown-Rump Length: Re-evaluation of Relation to Menstrual Age (5-18 weeks) with High-Resolution, Real-Time Ultrasound." *Radiology*, 182: (February 1992), 501-505.

Hansmann, M., et al. *Ultrasound Diagnosis in Obstetrics and Gynecology*. New York: Springer-Verlag, (1986), 439.

Osaka University. *Ultrasound in Obstetrics and Gynecology*. (July 20, 1990), 20 and 96.

Tokyo University. "Gestational Weeks and Computation Methods." *Ultrasound Imaging Diagnostics*, 12:1 (1982-1), 24-25, Table 3.

Femur Length (FL)

Chitty, L. S. and D.G. Altman. "New charts for ultrasound dating of pregnancy." *Ultrasound in Obstetrics and Gynecology* 10: (1997), 174-179, Table 8, 186.

Hadlock, F., et al. "Estimating Fetal Age: Computer-Assisted Analysis of Multiple Fetal Growth Parameters." *Radiology*, 152: (1984), 497-501.

Hansmann, M., et al. *Ultrasound Diagnosis in Obstetrics and Gynecology*. New York: Springer-Verlag, (1986), 431.

Osaka University. *Ultrasound in Obstetrics and Gynecology*. (July 20, 1990), 101-102.

University of Tokyo, Shinozuka, N. FJSUM, et al. "Standard Values of Ultrasonographic Fetal Biometry." *Japanese Journal of Medical Ultrasonics*, 23:12 (1996), 886.

Fetal Trunk Cross-Sectional Area (FTA)

Osaka University. *Ultrasound in Obstetrics and Gynecology*. (July 20, 1990), 99-100.

Gestational Sac (GS)

Hansmann, M., et al. *Ultrasound Diagnosis in Obstetrics and Gynecology*. New York: Springer-Verlag, (1986).

Nyberg, D.A., et al. "Transvaginal Ultrasound." *Mosby Yearbook*, (1992), 76.

Gestational sac measurements provide a fetal age based on the mean of one, two, or three distance measurements; however, Nyberg's gestational age equation requires all three distance measurements for an accurate estimate.

Tokyo University. "Gestational Weeks and Computation Methods." *Ultrasound Imaging Diagnostics*, 12:1 (1982-1).

Head Circumference (HC)

Chitty, L. S. and D.G. Altman. "New charts for ultrasound dating of pregnancy." *Ultrasound in Obstetrics and Gynecology* 10: (1997), 174-191, Table 5, 182.

Hadlock, F., et al. "Estimating Fetal Age: Computer-Assisted Analysis of Multiple Fetal Growth Parameters." *Radiology*, 152: (1984), 497-501.

Hansmann, M., et al. *Ultrasound Diagnosis in Obstetrics and Gynecology*. New York: Springer-Verlag, (1986), 431.

Occipito-Frontal Diameter (OFD)

Hansmann, M., et al. *Ultrasound Diagnosis in Obstetrics and Gynecology*. New York: Springer-Verlag, (1986), 431.

Transverse Trunk Diameter (TTD)

Hansmann, M., et al. *Ultrasound Diagnosis in Obstetrics and Gynecology*. New York: Springer-Verlag, (1986), 431.

University of Tokyo, Shinozuka, N. FJSUM, et al. "Standard Values of Ultrasonographic Fetal Biometry." *Japanese Journal of Medical Ultrasonics*, 23:12 (1996), 885.

Growth Analysis Tables

Abdominal Circumference (AC)

Chitty, Lyn S. et al. "Charts of Fetal Size: 3. Abdominal Measurements." *British Journal of Obstetrics and Gynaecology* 101: (February 1994), 131, Appendix: AC-Derived.

Hadlock, F., et al. "Estimating Fetal Age: Computer-Assisted Analysis of Multiple Fetal Growth Parameters." *Radiology*, 152: (1984), 497-501.

Jeanty P., E. Cousaert, and F. Cantraine. "Normal Growth of the Abdominal Perimeter." *American Journal of Perinatology*, 1: (January 1984), 129-135.

(Also published in Hansmann, Hackeloer, Staudach, Wittman. *Ultrasound Diagnosis in Obstetrics and Gynecology*. Springer-Verlag, New York, (1986), 179, Table 7.13.)

Biparietal Diameter (BPD)

Chitty, Lyn S. et al. "Charts of Fetal Size: 2. Head Measurements." *British Journal of Obstetrics and Gynaecology* 101: (January 1994), 43, Appendix: BPD-Outer-Inner.

Hadlock, F., et al. "Estimating Fetal Age: Computer-Assisted Analysis of Multiple Fetal Growth Parameters." *Radiology*, 152: (1984), 497-501.

Jeanty P., E. Cousaert, and F. Cantraine. "A Longitudinal Study of Fetal Limb Growth." *American Journal of Perinatology*, 1: (January 1984), 136-144, Table 5.

(Also published in Hansmann, Hackeloer, Staudach, Wittman. *Ultrasound Diagnosis in Obstetrics and Gynecology*. Springer-Verlag, New York, (1986), 176, Table 7.8.)

Estimated Fetal Weight (EFW)

Hadlock F., et al. "In Utero Analysis of Fetal Growth: A Sonographic Weight Standard." *Radiology*, 181: (1991), 129-133.

Jeanty, Philippe, F. Cantraine, R. Romero, E. Cousaert, and J. Hobbins. "A Longitudinal Study of Fetal Weight Growth." *Journal of Ultrasound in Medicine*, 3: (July 1984), 321-328, Table 1.

(Also published in Hansmann, Hackeloer, Staudach, and Wittman. *Ultrasound Diagnosis in Obstetrics and Gynecology*. Springer-Verlag, New York, (1986), 186, Table 7.20.)

Femur Length (FL)

Chitty, Lyn S. et al. "Charts of Fetal Size: 4. Femur Length." *British Journal of Obstetrics and Gynaecology* 101: (February 1994), 135.

Hadlock, F., et al. "Estimating Fetal Age: Computer-Assisted Analysis of Multiple Fetal Growth Parameters." *Radiology*, 152: (1984), 497-501.

Jeanty P., E. Cousaert, and F. Cantraine. "A Longitudinal Study of Fetal Limb Growth." *American Journal of Perinatology*, 1: (January 1984), 136-144, Table 5.

(Also published in Hansmann, Hackeloer, Staudach, Wittman. *Ultrasound Diagnosis in Obstetrics and Gynecology*. Springer-Verlag, New York, (1986), 182, Table 7.17.)

Head Circumference (HC)

Chitty, Lyn S., et al. "Charts of Fetal Size: 2. Head Measurements." *British Journal of Obstetrics and Gynaecology* 101: (January 1994), 43, Appendix: HC-Derived.

Hadlock, F., et al. "Estimating Fetal Age: Computer-Assisted Analysis of Multiple Fetal Growth Parameters." *Radiology*, 152: (1984), 497-501.

Jeanty P, E. Cousaert, and F. Cantraine. "A longitudinal study of Fetal Head Biometry." *American J of Perinatology*, 1: (January 1984), 118-128, Table 3.

(Also published in Hansmann, Hackeloer, Staudach, Wittman. *Ultrasound Diagnosis in Obstetrics and Gynecology*. Springer-Verlag, New York, (1986), 176, Table 7.8.)

Head Circumference (HC)/Abdominal Circumference (AC)

Campbell S., Thoms Alison. "Ultrasound Measurements of the Fetal Head to Abdomen Circumference Ratio in the Assessment of Growth Retardation," *British Journal of Obstetrics and Gynaecology*, 84: (March 1977), 165-174.

Ratio Calculations

FL/AC Ratio

Hadlock F.P., R. L. Deter, R. B. Harrist, E. Roecker, and S.K. Park. "A Date Independent Predictor of Intrauterine Growth Retardation: Femur Length/Abdominal Circumference Ratio," *American Journal of Roentgenology*, 141: (November 1983), 979-984.

FL/BPD Ratio

Hohler, C.W., and T.A. Quetel. "Comparison of Ultrasound Femur Length and Biparietal Diameter in Late Pregnancy," *American Journal of Obstetrics and Gynecology*, 141:7 (Dec. 1 1981), 759-762.

FL/HC Ratio

Hadlock F.P., R. B. Harrist, Y. Shah, and S. K. Park. "The Femur Length/Head Circumference Relation in Obstetric Sonography." *Journal of Ultrasound in Medicine*, 3: (October 1984), 439-442.

HC/AC Ratio

Campbell S., Thoms Alison. "Ultrasound Measurements of the Fetal Head to Abdomen Circumference Ratio in the Assessment of Growth Retardation," *British Journal of Obstetrics and Gynaecology*, 84: (March 1977), 165-174.

General References

+/x or S/D Ratio

$+/x = \text{abs}(\text{Velocity A}/\text{Velocity B})$

where A = velocity cursor +
 B = velocity cursor x

Acceleration Index (ACC)

Zwiebel, W.J. *Introduction to Vascular Ultrasonography*, 4th ed., W.B. Saunders Company, (2000), 52.

ACC = $\text{abs}(\text{delta velocity}/\text{delta time})$

Elapsed Time (ET)

ET = time between velocity cursors in milliseconds

Hip Angle/d:D Ratio

Graf, R. "Fundamentals of Sonographic Diagnosis of Infant Hip Dysplasia." *Journal of Pediatric Orthopedics*, Vol. 4, No. 6: 735-740, 1984.

Morin, C., Harcke, H., MacEwen, G. "The Infant Hip: Real-Time US Assessment of Acetabular Development." *Radiology* 177: 673-677, December 1985.

Intima Media Thickness (IMT)

Howard G, Sharrett AR, Heiss G, Evans GW, Chambless LE, Riley WA, et al. "Carotid Artery Intima-Medial Thickness Distribution in General Populations As Evaluated by B-Mode Ultrasound." ARIC Investigators. *Atherosclerosis Risk in Communities. Stroke.* (1993), 24:1297-1304.

O'Leary, Daniel H., MD and Polak, Joseph, F., MD, et al. "Use of Sonography to Evaluate Carotid Atherosclerosis in the Elderly. The Cardiovascular Health Study." *Stroke.* (September 1991), 22,1155-1163.

Redberg, Rita F., MD and Vogel, Robert A., MD, et al. "Task force #3—What is the Spectrum of Current and Emerging Techniques for the Noninvasive Measurement of Atherosclerosis?" *Journal of the American College of Cardiology.* (June 4, 2003), 41:11, 1886-1898.

Percent Area Reduction

Taylor K.J.W., P.N. Burns, P. Breslau. *Clinical Applications of Doppler Ultrasound*, Raven Press, N.Y., (1988), 130-136.

Zwiebel W.J., J.A. Zagzebski, A.B. Crummy, et al. "Correlation of peak Doppler frequency with lumen narrowing in carotid stenosis." *Stroke*, 3: (1982), 386-391.

$\% \text{ Area Reduction} = (1 - A2(\text{cm}^2)/A1(\text{cm}^2)) * 100$

where: A1 = original area of the vessel in square cm
 A2 = reduced area of the vessel in square cm

Percent Diameter Reduction

Handa, Nobuo et al., "Echo-Doppler Velocimeter in the Diagnosis of Hypertensive Patients: The Renal Artery Doppler Technique," *Ultrasound in Medicine and Biology*, 12:12 (1986), 945-952.

$$\% \text{ Diameter Reduction} = (1 - D2(\text{cm})/D1(\text{cm})) * 100$$

where: D1 = original diameter of the vessel in cm

D2 = reduced diameter of the vessel in cm

Pressure Gradient (PGr) in mmHG

Oh, J.K., J.B. Seward, A.J. Tajik. *The Echo Manual*. 2nd ed., Lippincott, Williams, and Wilkins, (1999), 64.
 $4 * (\text{Velocity})^2$

Peak E Pressure Gradient (E PG)

$$E \text{ PG} = 4 * PE^2$$

Peak A Pressure Gradient (A PG)

$$A \text{ PG} = 4 * PA^2$$

Peak Pressure Gradient (PGmax)

$$PG_{\text{max}} = 4 * PV^2$$

Mean Pressure Gradient (PGmean)

$$PG_{\text{mean}} = 4 * V_{\text{max}}^2$$

Pulsatility Index (PI)

Kurtz, A.B., W.D. Middleton. *Ultrasound-the Requisites*. Mosby Year Book, Inc., (1996), 469.

$$PI = (PSV - EDV)/V$$

where PSV = peak systolic velocity

EDV = end diastolic velocity

V = mean flow velocity throughout the entire cardiac cycle

Resistive Index (RI)

Kurtz, A.B., W.D. Middleton. *Ultrasound-the Requisites*. Mosby Year Book, Inc., (1996), 467.

RI = abs ((Velocity A – Velocity B)/Velocity A) in measurements

where A = velocity cursor +

B = velocity cursor x

Time Averaged Mean (TAM) in cm/s

TAM = mean (mean Trace)

Volume (Vol)

Beyer, W.H. *Standard Mathematical Tables*, 28th ed., CRC Press, Boca Raton, FL, (1987), 131.

Volume Flow (VF) in l/m

Allan, Paul L. et al. *Clinical Doppler Ultrasound*, 4th ed., Harcourt Publishers Limited. (2000), 36-38.

$$VF = CSA * TAM * .06$$

Chapter 8: Specifications

This chapter contains system and accessory specifications and agency approvals. The specifications for recommended peripherals can be found in the manufacturers' instructions.

System Dimensions

Length: 11.8 in. (29.97 cm)

Width: 10.8 in. (27.43 cm)

Height: 3.1 in. (7.87 cm)

Weight: 8.5 lbs. (3.9 kg) with the C60e transducer and battery installed

Display Dimensions

Length: 8.4 in. (21.34 cm)

Height: 6.3 in. (16 cm)

Diagonal: 10.4 in. (26.4 cm)

Transducers

C11e/8-5 MHz (6ft./1.8m)

C60e/5-2 MHz (5.5 ft./1.7 m)

D2/2 MHz (5.5 ft./1.7m)

HFL38/13-6 MHz (5.6 ft./1.7 m)

ICT/8-5 MHz (5.5 ft./1.7 m)

LAP/12-5 MHz (8.2 ft./2.5 m)

L25e/13-6 MHz (7.5ft./2.3m)

L38e/10-5 MHz (5.5 ft./1.7 m)

P10/8-4 MHz (6 ft./1.8 m)

P17/5-1 MHz(6 ft./1.8 m)

SLA/13-6 MHz (7.5 ft./2.3 m)

SLT/10-5 MHz (8.1 ft./2.5 m)

TEE/8-3 MHz (7.2 ft./2.2 m)

Imaging Modes

- 2D (256 gray shades)
- Color power Doppler (CPD) (256 colors)
- Color Doppler (Color) (256 colors)
- M Mode
- Pulsed wave (PW) Doppler
- Continuous Wave (CW) Doppler
- Tissue Doppler Imaging (TDI)
- Tissue Harmonic Imaging (THI)

Image Storage

The number of images saved to the CompactFlash card vary depending on the card storage capacity.
Cine buffer

Accessories

Hardware, Software, and Documentation

- American Institute of Ultrasound Medicine: Medical Safety Guidance
- Battery
- Biopsy Guide
- Carry case
- External display
- Footswitch
- BS EN 60601-2-37:2001: Annex HH
- Mobile Docking System Lite (MDS Lite)
- Mobile Docking System enhanced (MDSe)
- Mini-Dock
- Power supply
- Reference Guide
- SiteLink Image Manager
- SonoCalc IMT
- System User Guide
- Triple Transducer Connect
- Ultrasound gel

Cables

- ECG cable (6 ft./1.8 m)
- System AC power cord (10 ft./3.1 m)

Peripherals

See the manufacturer's specifications for the following peripherals.

Medical Grade

Black-and-white printer

Recommended sources for printer paper: Contact Sony at **1-800-686-7669** or **www.sony.com/professional** to order supplies or to obtain the name and number of the local distributor.

Color printer

DVD recorder

Video cassette recorder

Non-Medical Grade

Kensington Security Cable

Temperature and Humidity Limits

Note: The temperature, pressure, and humidity limits apply only to the ultrasound system and transducers.

Operating Limits: System

10–40°C (50–104°F), 15–95% R.H.
700 to 1060hPa (0.7 to 1.05 ATM)

Shipping/Storage Limits: System without Battery

-35–65°C (-31–149°F), 15–95% R.H.
500 to 1060hPa (0.5 to 1.05 ATM)

Operating Limits: Battery

10–40°C (50–104°F), 15–95% R.H.

Shipping/Storage Limits: Battery

-20–60°C (-4–140°F), 0–95% R.H.*
500 to 1060hPa (0.5 to 1.05 ATM)

* For storage longer than 30 days, store at or below room temperature.

Operating Limits: Transducer

10–40°C (50–104°F), 15–95% R.H.

Shipping/Storage Limits: Transducer

-35–65°C (-31–149°F), 15–95% R.H.

Electrical

Power Supply Input: 100-240 VAC, 50/60 Hz, 1.2 A Max @ 100 VAC.

Power Supply Output (system on): (1) 15 VDC, 2.7A Max (system)
(2) 12.6 VDC, 0.8A Max (battery charging)

Power Supply Output (system off): (1) 15 VDC, 2.0A Max (system)
(2) 12.6 VDC, 1.8A Max (battery charging)
Combined output not exceeding 52W.

Battery

6-cell, rechargeable lithium ion battery pack.

Run time is up to two hours, depending on imaging mode and display brightness.

Electromechanical Safety Standards

EN 60601-1:1997, European Norm, Medical Electrical Equipment–Part 1. General Requirements for Safety.

EN 60601-1-1:2001, European Norm, Medical Electrical Equipment–Part 1. General Requirements for Safety–Section 1-1. Collateral Standard. Safety Requirements for Medical Electrical Systems.

EN 60601-2-37:2001, European Norm, Particular requirements for the safety of ultrasonic medical diagnostic and monitoring equipment.

CAN/CSA C22.2, No. 601.1-M90:1990, Canadian Standards Association, Medical Electrical Equipment–Part 1. General Requirements for Safety.

CEI/IEC 61157:1992, International Electrotechnical Commission, Requirements for the Declaration of the Acoustic Output of Medical Diagnostic Ultrasonic Equipment.

UL 60601-1:2003, Underwriters Laboratories, Medical Electrical Equipment-Part 1: General Requirements for Safety.

EMC Standards Classification

EN 60601-1-2:2001, European Norm, Medical Electrical Equipment. General Requirements for Safety-Collateral Standard. Electromagnetic Compatibility. Requirements and Tests.

CISPR11:2004, International Electrotechnical Commission, International Special Committee on Radio Interference. Industrial, Scientific, and Medical (ISM) Radio-Frequency Equipment Electromagnetic Disturbance Characteristics-Limits and Methods of Measurement.

The Classification for the SonoSite system, SiteStand, accessories, and peripherals when configured together is: Group 1, Class A.

Airborne Equipment Standards

RTCA/DO-160E:2004, Radio Technical Commission for Aeronautics, Environmental Conditions and Test Procedures for Airborne Equipment, Section 21.0 Emission of Radio Frequency Energy, Category B.

DICOM Standard

NEMA PS 3.15: 2000, Digital Imaging and Communications in Medicine (DICOM)-Part 15: Security Profiles.

HIPAA Standard

The Health Insurance and Portability and Accountability Act, Pub.L. No. 104-191 (1996).

45 CFR 160, General Administrative Requirements.

45 CFR 164, Security and Privacy.

Chapter 9: Safety

Read this information before using the ultrasound system. The information in this guide applies to the ultrasound system, transducer, accessories, and peripherals. This chapter contains information required by various regulatory agencies, including information about the ALARA (as low as reasonably achievable) principle, the output display standard, acoustic power and intensity tables, and other safety information.

A **WARNING** describes precautions necessary to prevent injury or loss of life.

A **Caution** describes precautions necessary to protect the products.

Ergonomic Safety

WARNING: To prevent musculoskeletal disorders, follow the [“Healthy Scanning Guidelines”](#) on page 9.

Electrical Safety Classification

Class I equipment	Ultrasound system powered from power supply or part of the Mobile Docking System
Class II equipment	Ultrasound system not connected to the power supply (battery only)
Type BF applied parts	Ultrasound transducers
Type CF applied parts	ECG module/ECG leads
IPX-7 (watertight equipment)	Ultrasound transducers
IPX-8 (watertight equipment)	Footswitch
Non AP/APG	Ultrasound system power supply, Mobile Docking System, and peripherals. Equipment is not suitable for use in the presence of flammable anaesthetics.

Electrical Safety

This system meets EN60601-1, Class I/internally-powered equipment requirements and Type BF isolated patient-applied parts safety requirements.

This system complies with the applicable medical equipment requirements published in the Canadian Standards Association (CSA), European Norm Harmonized Standards, and Underwriters Laboratories (UL) safety standards. See [Chapter 8, "Specifications."](#)

For maximum safety observe the following warnings and cautions.

- WARNING:** To avoid discomfort or minor risk of patient injury, keep hot surfaces away from the patient.
- Under certain circumstances, the transducer connector and back of the display enclosure can reach temperatures that exceed EN60601-1 limits for patient contact, therefore only the operator shall handle the system. This does not include the transducer face.
- To avoid discomfort or minor risk of operator injury when handling the transducer connector, the system should not be operated for more than 60 minutes continuously in a live-scan mode (as opposed to freeze or sleep modes).
- To avoid the risk of electrical shock or injury, do not open the system enclosures. All internal adjustments and replacements, except battery replacement, must be made by a qualified technician.
- To avoid the risk of injury, do not operate the system in the presence of flammable gasses or anesthetics. Explosion can result.
- To avoid the risk of electrical shock, use only properly grounded equipment. Shock hazards exist if the power supply is not properly grounded. Grounding reliability can only be achieved when equipment is connected to a receptacle marked "Hospital Only" or "Hospital Grade" or the equivalent. The grounding wire must not be removed or defeated.
- To avoid the risk of electrical shock, when using the system in an environment where the integrity of the protective earth conductor arrangement is in doubt, operate the system on battery power only without using the power supply.
- To avoid the risk of electrical shock, do not connect the system's power supply or a docking system to an MPSO or extension cord.
- To avoid the risk of electrical shock, before using the transducer, inspect the transducer face, housing, and cable. Do not use the transducer if the transducer or cable is damaged.
- To avoid the risk of electrical shock, always disconnect the power supply from the system before cleaning the system.
- To avoid the risk of electrical shock, do not use any transducer that has been immersed beyond the specified cleaning or disinfection level. See [Chapter 6, "Troubleshooting and Maintenance."](#)

- WARNING:** To avoid the risk of electrical shock and fire hazard, inspect the power supply, AC power cord, and plug on a regular basis. Ensure they are not damaged.
- To avoid the risk of electrical shock and fire hazard, the power cord set that connects the power supply of the ultrasound system or MDS to mains power must only be used with the power supply or MDS, and cannot be used to connect other devices to mains power.
- To avoid the risk of electrical shock, use only accessories and peripherals recommended by SonoSite, including the power supply. Connection of accessories and peripherals not recommended by SonoSite could result in electrical shock. Contact SonoSite or your local representative for a list of accessories and peripherals available from or recommend by SonoSite.
- To avoid the risk of electrical shock, use commercial grade peripherals recommended by SonoSite on battery power only. Do not connect these products to AC mains power when using the system to scan or diagnose a patient/subject. Contact SonoSite or your local representative for a list of the commercial grade peripherals available from or recommended by SonoSite.
- To avoid the risk of electrical shock, inspect cables and power cords used within the system on a regular basis for damage.
- To avoid the risk of electrical shock to the patient/subject, do not touch the system battery contacts while simultaneously touching a patient/subject.
- To prevent injury to the operator/bystander, the transducer must be removed from patient contact before the application of a high-voltage defibrillation pulse.
- To avoid possible electrical shock or electromagnetic interference, verify proper operation and compliance with relevant safety standards for all equipment before clinical use. Connecting additional equipment to the ultrasound system constitutes configuring a medical system. SonoSite recommends verifying that the system, all combinations of equipment, and accessories connected to the ultrasound system comply with JACHO installation requirements and/or safety standards such as AAMI-ES1, NFPA 99 OR IEC Standard 60601-1-1 and electromagnetic compatibility standard IEC 60601-1-2 (Electromagnetic compatibility), and are certified according to IEC Standard 60950 (Information Technology Equipment (ITE)).
- Caution:** Do not use the system if an error message appears on the image display: note the error code; call SonoSite or your local representative; turn off the system by pressing and holding the power key until the system powers down.
- To avoid increasing the system and transducer connector temperature, do not block the airflow to the ventilation holes on the side of the system.

Equipment Safety

To protect your ultrasound system, transducer, and accessories, follow these precautions.

- Caution:** Excessive bending or twisting of cables can cause a failure or intermittent operation.
- Improper cleaning or disinfecting of any part of the system can cause permanent damage. For cleaning and disinfecting instructions, see [Chapter 6, "Troubleshooting and Maintenance."](#)
- Do not submerge the transducer connector in solution. The cable is not liquid-tight beyond the transducer connector/cable interface.
- Do not use solvents such as thinner or benzene, or abrasive cleaners on any part of the system.
- Remove the battery from the system if the system is not likely to be used for some time.
- Do not spill liquid on the system.

Battery Safety

To prevent the battery from bursting, igniting, or emitting fumes and causing personal injury or equipment damage, observe the following precautions.

- WARNING:** The battery has a safety device. Do not disassemble or alter the battery.
- Charge the batteries only when the ambient temperature is between 0° and 40°C (32° and 104°F).
- Do not short-circuit the battery by directly connecting the positive and negative terminals with metal objects.
- Do not heat the battery or discard it in a fire.
- Do not expose the battery to temperatures over 60°C (140°F). Keep it away from fire and other heat sources.
- Do not charge the battery near a heat source, such as a fire or heater.
- Do not leave the battery in direct sunlight.
- Do not pierce the battery with a sharp object, hit it, or step on it.
- Do not use a damaged battery.
- Do not solder a battery.
- The polarity of the battery terminals are fixed and cannot be switched or reversed. Do not force the battery into the system.
- Do not connect the battery to an electrical power outlet.

WARNING: Do not continue recharging the battery if it does not recharge after two successive six hour charging cycles.

If the battery leaks or emits an odor, remove it from all possible flammable sources.

Caution: To avoid the battery bursting, igniting, or emitting fumes from the battery and causing equipment damage, observe the following precautions:

Do not immerse the battery in water or allow it to get wet.

Do not put the battery into a microwave oven or pressurized container.

If the battery emits an odor or heat, is deformed or discolored, or in any way appears abnormal during use, recharging or storage, immediately remove it and stop using it. If you have any questions about the battery, consult SonoSite or your local representative.

Store the battery between -20°C (-4°F) and 60°C (140°F).

Use only SonoSite batteries.

Do not use or charge the battery with non-SonoSite equipment. Only charge the battery with the system.

Biological Safety

Observe the following precautions related to biological safety.

WARNING:

To avoid device damage or patient injury, do not use the P10/P17 needle guide bracket on patients with pacemakers or medical electronic implants. The needle guide bracket for the P10 and P17 transducers contains a magnet that is used to ensure the bracket is correctly oriented on the transducer. The magnetic field in direct proximity to the pacemaker or medical electronic implant may have an adverse effect.

Non-medical (commercial) grade peripheral monitors have not been verified or validated by SonoSite as being suitable for diagnosis.

To avoid the risk of a burn hazard, do not use the transducer with high frequency surgical equipment. Such a hazard may occur in the event of a defect in the high frequency surgical neutral electrode connection.

Do not use the system if it exhibits erratic or inconsistent behavior. Discontinuities in the scanning sequence are indicative of a hardware failure that must be corrected before use.

Some transducer sheaths contain natural rubber latex and talc, which can cause allergic reactions in some individuals. Refer to 21 CFR 801.437, User labeling for devices that contain natural rubber.

Perform ultrasound procedures prudently. Use the ALARA (as low as reasonably achievable) principle and follow the prudent use information concerning MI and TI.

SonoSite does not currently recommend a specific brand of acoustic standoff. If an acoustic standoff is used, it must have a minimum attenuation of .3dB/cm/MHz.

Some SonoSite transducers are approved for intraoperative applications if a market-cleared sheath is used.

Electromagnetic Compatibility (EMC)

The ultrasound system has been tested and found to comply with the electromagnetic compatibility (EMC) limits for medical devices to IEC 60601-1-2:2001. These limits are designed to provide reasonable protection against harmful interference in a typical medical installation.

Caution:

Medical electrical equipment requires special precautions regarding EMC and must be installed and operated according to these instructions. It is possible that high levels of radiated or conducted radio-frequency electromagnetic interference (EMI) from portable and mobile RF communications equipment or other strong or nearby radio-frequency sources, could result in performance disruption of the ultrasound system. Evidence of disruption may include image degradation or distortion, erratic readings, equipment ceasing to operate, or other incorrect functioning. If this occurs, survey the site to determine the source of disruption, and take the following actions to eliminate the source(s).

- Turn equipment in the vicinity off and on to isolate disruptive equipment.
- Relocate or re-orient interfering equipment.
- Increase distance between interfering equipment and your ultrasound system.
- Manage use of frequencies close to ultrasound system frequencies.
- Remove devices that are highly susceptible to EMI.
- Lower power from internal sources within facility control (such as paging systems).
- Label devices susceptible to EMI.
- Educate clinical staff to recognize potential EMI-related problems.
- Eliminate or reduce EMI with technical solutions (such as shielding).
- Restrict use of personal communicators (cell phones, computers) in areas with devices susceptible to EMI.
- Share relevant EMI information with others, particularly when evaluating new equipment purchases which may generate EMI.
- Purchase medical devices that comply with IEC 60601-1-2 EMC Standards.

To avoid the risk of increased electromagnetic emissions or decreased immunity, use only accessories and peripherals recommended by SonoSite. Connection of accessories and peripherals not recommended by SonoSite could result in malfunctioning of your ultrasound system or other medical electrical devices in the area. Contact SonoSite or your local representative for a list of accessories and peripherals available from or recommended by SonoSite. See the SonoSite accessories user guide.

Electrostatic discharge (ESD), or static shock, is a naturally occurring phenomenon. ESD is common in conditions of low humidity, which can be caused by heating or air conditioning. Static shock is a discharge of the electrical energy from a charged body to a lesser or non-charged body. The degree of discharge can be significant enough to cause damage to a transducer or an ultrasound system. The following precautions can help reduce ESD: anti-static spray on carpets, anti-static spray on linoleum, and anti-static mats.

Manufacturer's Declaration

Table 1 and Table 2 document the intended use environment and EMC compliance levels of the system. For maximum performance, ensure that the system is used in the environments described in this table.

The system is intended for use in the electromagnetic environment specified below.

Table 1: Manufacturer's Declaration - Electromagnetic Emissions

Emissions Test	Compliance	Electromagnetic Environment
RF emissions CISPR 11	Group 1	The SonoSite ultrasound system uses RF energy only for its internal function. Therefore, its RF emissions are very low and are not likely to cause any interference in nearby electronic equipment.
RF emissions CISPR 11	Class A	The SonoSite ultrasound system is suitable for use in all establishments other than domestic and those directly connected to the public low-voltage power supply network which supplies buildings used for domestic purposes.
Harmonic emissions IEC 61000-3-2	Class A	
Voltage fluctuations/ flicker emissions IEC 61000-3-3	Complies	

The system is intended for use in the electromagnetic environment specified below.

Table 2: Manufacturer's Declaration - Electromagnetic Immunity

Immunity Test	IEC 60601 Test Level	Compliance Level	Electromagnetic Environment
Electrostatic Discharge (ESD) IEC 61000-4-2	2.0KV, 4.0KV, 6.0KV contact 2.0KV, 4.0KV, 8.0KV air	2.0KV, 4.0KV, 6.0KV contact 2.0KV, 4.0KV, 8.0KV air	Floors should be wood, concrete or ceramic tile. If floors are covered with synthetic material, the relative humidity should be at least 30%.
Electrical fast Transient burst IEC 61000-4-4	2KV on the mains 1KV on signal lines	2KV on the mains 1KV on signal lines	Mains power quality should be that of a typical commercial or hospital environment.

Table 2: Manufacturer's Declaration - Electromagnetic Immunity (Continued)

Immunity Test	IEC 60601 Test Level	Compliance Level	Electromagnetic Environment
Surge IEC 61000-4-5	0.5KV, 1.0KV, 2.0KV on AC power lines to ground 0.5KV, 1.0KV on AC power lines to lines	0.5KV, 1.0KV, 2.0KV on AC power lines to ground 0.5KV, 1.0KV on AC power lines to lines	Mains power quality should be that of a typical commercial or hospital environment.
Voltage dips, short interruptions and voltage variations on power supply input lines IEC 61000-4-11	>5% U_T (>95% dip in U_T) for 0.5 cycle 40% U_T (60% dip in U_T) for 5 cycles 70% U_T (30% dip in U_T) for 25 cycles >5% U_T (>95% dip in U_T) for 5s	>5% U_T (>95% dip in U_T) for 0.5 cycle 40% U_T (60% dip in U_T) for 5 cycles 70% U_T (30% dip in U_T) for 25 cycles >5% U_T (>95% dip in U_T) for 5s	Mains power quality should be that of a typical commercial or hospital environment. If the user of the SonoSite ultrasound system requires continued operation during power mains interruptions, it is recommended that the SonoSite ultrasound system be powered from an uninterruptible power supply or a battery.
Power Frequency Magnetic Field IEC 61000-4-8	3 A/m	3 A/m	If image distortion occurs, it may be necessary to position the SonoSite ultrasound system further from sources of power frequency magnetic fields or to install magnetic shielding. The power frequency magnetic field should be measured in the Intended installation location to assure that it is sufficiently low.
Conducted RF IEC 61000-4-6	3 Vrms 150 kHz to 80 MHz	3 Vrms	Portable and mobile RF communications equipment should be used no closer to any part of the SonoSite ultrasound system including cables, than the recommended separation distance calculated from the equation applicable to the frequency of the transmitter. Recommended Separation Distance $d = 1.2 \sqrt{P}$

Table 2: Manufacturer’s Declaration - Electromagnetic Immunity (Continued)

Immunity Test	IEC 60601 Test Level	Compliance Level	Electromagnetic Environment
Radiated RF IEC 61000-4-3	3 Vim 80 MHz to 2.5 GHz	3 V/m	$d = 1.2 \sqrt{P}$ 80 MHz to 800 MHz $d = 2.3 \sqrt{P}$ 800 MHz to 2,5 GHz Where P is the maximum output power rating of the transmitter in watts (W) according to the transmitter manufacturer and d is the recommended separation distance in meters (m).
Radiated RF IEC 61000-4-3 (continued)			Field strengths from fixed RF transmitters, as determined by an electromagnetic Site survey ^a , should be less than the compliance level in each frequency range ^b . Interference may occur in the vicinity of equipment marked with the following symbol:  (IEC 60417 No. 417-IEC-5140: “Source of non-ionizing radiation”)

Note: U_T is the AC mains voltage prior to application of the test level.

Note: At 80 MHz and 800 MHz, the higher frequency range applies.

Note: These guidelines may not apply in all situations. Electromagnetic propagation is affected by absorption and reflection from structures, objects and people.

- a. Field strengths from fixed transmitters such as base stations for radio (cellular/cordless) telephones and land mobile radios, amateur radio, AM and FM radio broadcast and TV broadcast cannot be predicted theoretically with accuracy. To assess the electromagnetic environment due to fixed RF transmitters, an electromagnetic site survey should be considered. If the measured field strength in the location in which the SonoSite ultrasound system is used exceeds the applicable RF compliance level above, the SonoSite ultrasound system should be observed to verify normal operation. If abnormal performance is observed, additional measures may be necessary, such as re-orienting or relocating the SonoSite ultrasound system.
- b. Over the frequency range 150 kHz to 80 MHz, field strengths should be less than 3 V/m.

The ALARA Principle

ALARA is the guiding principle for the use of diagnostic ultrasound. Sonographers and other qualified ultrasound users, using good judgment and insight, determine the exposure that is “as low as reasonably achievable.” There are no set rules to determine the correct exposure for every situation. The qualified ultrasound user determines the most appropriate way to keep exposure low and bioeffects to a minimum, while obtaining a diagnostic examination.

A thorough knowledge of the imaging modes, transducer capability, system setup and scanning technique is necessary. The imaging mode determines the nature of the ultrasound beam. A stationary beam results in a more concentrated exposure than a scanned beam, which spreads that exposure over that area. The transducer capability depends upon the frequency, penetration, resolution, and field of view. The default system presets are reset at the start of each new patient. It is the scanning technique of the qualified ultrasound user along with patient variability that determines the system settings throughout the exam.

The variables which affect the way the qualified ultrasound user implements the ALARA principle include: patient body size, location of the bone relative to the focal point, attenuation in the body, and ultrasound exposure time. Exposure time is an especially useful variable, because the qualified ultrasound user can control it. The ability to limit the exposure over time supports the ALARA principle.

Applying ALARA

The system imaging mode selected by the qualified ultrasound user is determined by the diagnostic information required. 2D imaging provides anatomical information; CPD imaging provides information about the energy or amplitude strength of the Doppler signal over time at a given anatomical location and is used for detecting the presence of blood flow; Color imaging provides information about the energy or amplitude strength of the Doppler signal over time at a given anatomical location and is used for detecting the presence, velocity, and direction of blood flow; Tissue Harmonic Imaging uses higher received frequencies to reduce clutter, artifact, and improve resolution on the 2D image. Understanding the nature of the imaging mode used allows the qualified ultrasound user to apply the ALARA principle.

Prudent use of ultrasound requires that patient exposure to ultrasound be limited to the lowest ultrasound output for the shortest time necessary to achieve acceptable diagnostic results. Decisions that support prudent use are based on the type of patient, exam type, patient history, ease or difficulty of obtaining diagnostically useful information, and potential localized heating of the patient due to transducer surface temperature.

The system has been designed to ensure that temperature at the face of the transducer will not exceed the limits established in Section 42 of EN 60601-2-37: Particular requirement for the safety of ultrasound medical diagnostic and monitoring equipment. See [“Transducer Surface Temperature Rise”](#) on page 242. In the event of a device malfunction, there are redundant controls that limit transducer power. This is accomplished by an electrical design that limits both power supply current and voltage to the transducer.

The sonographer uses the system controls to adjust image quality and limit ultrasound output. The system controls are divided into three categories relative to output: controls that directly affect output, controls that indirectly affect output, and receiver controls.

Direct Controls

The system does not exceed a spatial peak temporal average intensity (ISPTA) of 720 mW/cm² for all imaging modes. (For ophthalmic use the Orb exam mode is limited to the following values: ISPTA does not exceed 50 mW/cm²; TI does not exceed 1.0, and MI does not exceed 0.23.) The mechanical index (MI) and thermal index (TI) may exceed values greater than 1.0 on some transducers in some imaging modes. One may monitor the MI and TI values and adjust the controls to reduce these values. See “Guidelines for Reducing MI and TI” on page 237. Additionally, one means for meeting the ALARA principle is to set the MI or TI values to a low index value and then modifying this level until a satisfactory image or Doppler mode is obtained. For more information on MI and TI, see BS EN 60601-2-37:2001: Annex HH.

Indirect Controls

The controls that indirectly affect output are controls affecting imaging mode, freeze, and depth. The imaging mode determines the nature of the ultrasound beam. Tissue attenuation is directly related to transducer frequency. The higher the PRF (pulse repetition frequency), the more output pulses occur over a period of time.

Receiver Controls

The receiver controls are the gain controls. Receiver controls do not affect output. They should be used, if possible, to improve image quality before using controls that directly or indirectly affect output.

Acoustic Artifacts

An acoustic artifact is information, present or absent in an image, that does not properly indicate the structure or flow being imaged. There are helpful artifacts that aid in diagnosis and those that hinder proper interpretation. Examples of artifacts include:

- Shadowing
- Through transmission
- Aliasing
- Reverberations
- Comet tails

For more information on detecting and interpreting acoustic artifacts, see the following reference:

Kremkau, Frederick W. *Diagnostic Ultrasound: Principles and Instruments*. 7th ed., W.B. Saunders Company, (Oct. 17, 2005).

Guidelines for Reducing MI and TI

The following are general guidelines for reducing MI or TI. If multiple parameters are given then the best results may be achieved by minimizing these parameters simultaneously. In some modes changing these parameters will not affect MI or TI. Changes to other parameters may also result in MI and TI reductions. Please note the 'MI' or 'TI' read out on the right side of the LCD screen.

“↓” means to decrease or lower setting of parameter to reduce MI or TI. “↑” means to raise or increase setting of parameter to reduce MI or TI

The D2/2 transducer has a static continuous wave (CW) output. This output is fixed, thus TI and MI values cannot be changed by any of the system controls available to the user.

Table 3: MI

Transducer	Depth
C11e	↑
C60e	↑
HFL38	↑
ICT	↑
LAP	↑
L25e	↑
L38e	↑
P10	↓
P17	↑
SLA	↑
SLT	↑
TEE	↓

Table 4: TI (TIS, TIC, TIB)

Transducer	Color Power Doppler Settings					Optimize	PW Settings
	Box Width	Box Height	Box Depth	PRF	Depth		
C11e			↑	↓	↑		↓ (Depth)
C60e	↓		↑	↓	↑		↓ (PRF)
HFL38			↑	↑	↑		↓ (Depth)
ICT		↑	↑	↓		Exam Gyn	↓ (PRF)
LAP					↑		↓ (Depth)
L25e	↓				↑		↓ (PRF)
L38e				↓			↓ (Depth)
P10			↑	↓			↓ (PRF)
P17		↓		↓	↑		↓ (PRF)
SLA			↑	↓	↑		↓ (PRF)
SLT				↓	↑		↓ (PRF)
TEE				↓	↓	Gen, Color High	↓ (Depth)

Output Display

The system meets the AIUM output display standard for MI and TI (see last reference listed in “[Related Guidance Documents](#)” below). [Table 5](#) indicates for each transducer and operating mode when either the TI or MI is greater than or equal to a value of 1.0, thus requiring display.

Table 5: Cases Where Either a Thermal or Mechanical Index is ≥ 1.0

Transducer Model	Index	2D/ M Mode	CPD/ Color	PW Doppler	CW Doppler
C11e/8-5	MI	No	No	No	No
	TIC, TIB, or TIS	No	No	Yes	—
C60e/5-2	MI	Yes	No	No	—
	TIC, TIB, or TIS	No	No	Yes	—
D2/2	MI	—	—	—	No
	TIC, TIB, or TIS	—	—	—	Yes
HFL38/13-6	MI	No	Yes	No	—
	TIC, TIB, or TIS	No	Yes	Yes	—
ICT/8-5	MI	No	No	No	—
	TIC, TIB, or TIS	No	Yes	Yes	—
LAP/12-5	MI	Yes	No	No	—
	TIC, TIB, or TIS	Yes	No	Yes	—
L25e/13-6	MI	No	No	No	—
	TIC, TIB, or TIS	No	No	Yes	—
L38e/10-5	MI	Yes	Yes	Yes	—
	TIC, TIB, or TIS	Yes	Yes	Yes	—
P10/8-4	MI	Yes	No	Yes	No
	TIC, TIB, or TIS	No	Yes	Yes	Yes
P17/5-1	MI	Yes	Yes	Yes	No
	TIC, TIB, or TIS	Yes	Yes	Yes	Yes
SLA/13-6	MI	Yes	Yes	No	—
	TIC, TIB, or TIS	No	No	Yes	—

Table 5: Cases Where Either a Thermal or Mechanical Index is ≥ 1.0 (Continued)

Transducer Model	Index	2D/ M Mode	CPD/ Color	PW Doppler	CW Doppler
SLT/10-5	MI	Yes	Yes	No	—
	TIC, TIB, or TIS	Yes	No	Yes	—
TEE/8-3	MI	Yes	No	No	No
	TIC, TIB, or TIS	Yes	Yes	Yes	Yes

Even when MI is less than 1.0, the system provides a continuous real-time display of MI whenever a transducer is operated in a 2D imaging mode. The index is displayed in increments of 0.1.

The system meets the output display standard for TI. A continuous real-time display of TI is provided for the operator whenever a transducer is operated in a CPD, Color, M Mode, or PW Doppler imaging mode. The index is displayed in increments of 0.1.

The thermal index consists of three user selectable indices, and only one of these is displayed at any one time. In order to display properly and meet the ALARA principle, the user selects an appropriate TI based on the specific exam being performed. SonoSite provides the AIUM Medical Ultrasound Safety reference which contains guidance on how to determine which TI is appropriate (see second reference listed in [“Related Guidance Documents”](#) on page 241).

Mechanical and Thermal Indices Output Display Accuracy

The accuracy result for the mechanical index (MI) is stated statistically. With 90% confidence, 90% of the measured MI values will be within +16% to -31% of the displayed MI value, or +0.2 of the displayed value, whichever value is larger.

The accuracy result for the thermal index (TI) is stated statistically. With 90% confidence, 90% of the measured TI values will be within +26% to -50% of the displayed TI value, or +0.2 of the displayed value, whichever value is larger. The values equate to +1dB to -3dB.

A displayed value of 0.0 for MI or TI means that the calculated estimate for the index is less than 0.05.

Factors that Contribute to Display Uncertainty

The net uncertainty of the displayed indices is derived by combining the quantified uncertainty from three sources; measurement uncertainty, system and transducer variability, and engineering assumptions and approximations made when calculating the display values.

Measurement errors of the acoustic parameters when taking the reference data are the major source of error that contributes to the display uncertainty. The measurement error is described in [“Acoustic Measurement Precision and Uncertainty”](#) on page 283.

The displayed MI and TI values are based on calculations that use a set of acoustic output measurements that were made using a single reference ultrasound system with a single reference transducer that is representative of the population of transducers of that type. The reference system and transducer are chosen from a sample population of systems and transducers taken from early production units, and they are selected based on having an acoustic output that is representative of

the nominal expected acoustic output for all transducer/system combinations that might occur. Of course every transducer/system combination has its own unique characteristic acoustic output, and will not match the nominal output on which the display estimates are based. This variability between systems and transducers introduces an error into displayed value. By doing acoustic output sampling testing during production, the amount of error introduced by the variability is bounded. The sampling testing ensures that the acoustic output of transducers and systems being manufactured stays within a specified range of the nominal acoustic output.

Another source of error arises from the assumptions and approximations that are made when deriving the estimates for the display indices. Chief among these assumptions is that the acoustic output, and thus the derived display indices, are linearly correlated with the transmit drive voltage of the transducer. Generally, this assumption is very good, but it is not exact, and thus some error in the display can be attributed to the assumption of voltage linearity.

Related Guidance Documents

- Information for Manufacturers Seeking Marketing Clearance of Diagnostic Ultrasound Systems and Transducers, FDA, 1997.
- Medical Ultrasound Safety, American Institute of Ultrasound in Medicine (AIUM), 1994. (A copy is included with each system.)
- Acoustic Output Measurement Standard for Diagnostic Ultrasound Equipment, NEMA UD2-2004.
- Acoustic Output Measurement and Labeling Standard for Diagnostic Ultrasound Equipment, American Institute of Ultrasound in Medicine, 1993.
- Standard for Real-Time Display of Thermal and Mechanical Acoustic Output Indices on Diagnostic Ultrasound Equipment, NEMA UD3-2004.
- Guidance on the interpretation of TI and MI to be used to inform the operator, Annex HH, BS EN 60601-2-37 reprinted at P05699.

Transducer Surface Temperature Rise

Table 6 and Table 7 list the measured surface temperature rise from ambient* of transducers used on the MicroMaxx. The temperatures were measured in accordance with EN 60601-2-37 section 42 where controls and settings were positioned to give maximum temperatures

Test 1: The transducer surface temperature test on tissue mimicking material (TMM) is based on the following standard: 42.3(a) 1, Test Method B (IEC 60601-2-37, Amendment 1). The limit is a 10°C rise from ambient, as measured on the TMM.

Test 2: The transducer surface temperature test in air is based on the following standard: 42.3(a) 2 (IEC 60601-2-37, Amendment 1). The limit is a 27°C rise from ambient.

Test 3: The transducer surface temperature test on TMM is based on the following standard: 42.3(a) 1, Test Method B (IEC 60601-2-37, Amendment 1). The limit is a 6°C rise from ambient, as measured on the TMM.

*The ambient temperature shall be 23°C ± 3°C.

Table 6: Transducer Surface Temperature Rise EN 60601-2-37 (External Use)

Test	C11e	C60e	D2	HFL38	L25e	L38e	P10	P17
1	9.2°C	9.0°C	3.1°C	9.5°C	9.5°C	8.7°C	8.0°C	8.5°C
2	19.7°C	20.5°C	9.1°C	24.5°C	18.2°C	21.7°C	19.7°C	25.6°C

Table 7: Transducer Surface Temperature Rise IEC 60601-2-37 (Internal Use)

Test	ICT	LAP	SLA	SLT	TEE
3	5.5°C	5.4°C	5.4°C	5.5°C	3.5°C
2	23.3°C	11.7°C	20.8°C	16.5°C	17.8°C

Acoustic Output Measurement

Since the initial use of diagnostic ultrasound, the possible human biological effects (bioeffects) from ultrasound exposure have been studied by various scientific and medical institutions. In October 1987, the American Institute of Ultrasound in Medicine (AIUM) ratified a report prepared by its Bioeffects Committee (Bioeffects Considerations for the Safety of Diagnostic Ultrasound, J Ultrasound Med., Sept. 1988: Vol. 7, No. 9 Supplement), sometimes referred to as the Stowe Report, which reviewed available data on possible effects of ultrasound exposure. Another report "Bioeffects and Safety of Diagnostic Ultrasound," dated January 28, 1993 provides more current information. The acoustic output for this ultrasound system has been measured and calculated in accordance with the "Acoustic Output Measurement Standard for Diagnostic Ultrasound Equipment" (NEMA UD2-2004), and the "Standard for Real-Time Display of Thermal and Mechanical Acoustic Output Indices on Diagnostic Ultrasound Equipment" (NEMA UDe3-2004).

In Situ, Derated, and Water Value Intensities

All intensity parameters are measured in water. Since water does not absorb acoustic energy, these water measurements represent a worst case value. Biological tissue does absorb acoustic energy. The true value of the intensity at any point depends on the amount, type of tissue, and the frequency of the ultrasound passing through the tissue. The intensity value in the tissue, *In Situ*, has been estimated by using the following formula:

$$In\ Situ = Water [e^{-0.23alf}]$$

where:

In Situ = *In Situ* intensity value

Water = Water intensity value

e = 2.7183

a = attenuation factor (dB/cm MHz)

Attenuation factor (a) for various tissue types are given below:

brain = 0.53

heart = 0.66

kidney = 0.79

liver = 0.43

muscle = 0.55

l = skinline to measurement depth in cm

f = center frequency of the transducer/system/mode combination in MHz

Since the ultrasonic path during the exam is likely to pass through varying lengths and types of tissue, it is difficult to estimate the true *In Situ* intensity. An attenuation factor of 0.3 is used for general reporting purposes; therefore, the *In Situ* value commonly reported uses the formula:

$$In\ Situ\ (derated) = Water [e^{-0.069lf}]$$

Since this value is not the true *In Situ* intensity, the term "derated" is used to qualify it.

The maximum derated and the maximum water values do not always occur at the same operating conditions; therefore, the reported maximum water and derated values may not be related by the *In Situ* (derated) formula. For example: a multi-zone array transducer that has maximum water value intensities in its deepest zone, but also has the smallest derating factor in that zone. The same transducer may have its largest derated intensity in one of its shallowest focal zones.

Tissue Models and Equipment Survey

Tissue models are necessary to estimate attenuation and acoustic exposure levels *In Situ* from measurements of acoustic output made in water. Currently, available models may be limited in their accuracy because of varying tissue paths during diagnostic ultrasound exposures and uncertainties in the acoustic properties of soft tissues. No single tissue model is adequate for predicting exposures in all situations from measurements made in water, and continued improvement and verification of these models is necessary for making exposure assessments for specific exam types.

A homogeneous tissue model with attenuation coefficient of 0.3 dB/cm MHz throughout the beam path is commonly used when estimating exposure levels. The model is conservative in that it overestimates the *In Situ* acoustic exposure when the path between the transducer and site of interest is composed entirely of soft tissue. When the path contains significant amounts of fluid, as in many first and second-trimester pregnancies scanned transabdominally, this model may underestimate the *In Situ* acoustic exposure. The amount of underestimation depends upon each specific situation.

Fixed-path tissue models, in which soft tissue thickness is held constant, sometimes are used to estimate *In Situ* acoustic exposures when the beam path is longer than 3 cm and consists largely of fluid. When this model is used to estimate maximum exposure to the fetus during transabdominal scans, a value of 1 dB/cm MHz may be used during all trimesters.

Existing tissue models that are based on linear propagation may underestimate acoustic exposures when significant saturation due to non-linear distortion of beams in water is present during the output measurement.

The maximum acoustic output levels of diagnostic ultrasound devices extend over a broad range of values:

- A survey of 1990-equipment models yielded MI values between 0.1 and 1.0 at their highest output settings. Maximum MI values of approximately 2.0 are known to occur for currently available equipment. Maximum MI values are similar for real-time 2D and M Mode imaging.
- Computed estimates of upper limits to temperature elevations during transabdominal scans were obtained in a survey of 1988 and 1990 pulsed Doppler equipment. The vast majority of models yielded upper limits less than 1° and 4°C (1.8° and 7.2°F) for exposures of first-trimester fetal tissue and second-trimester fetal bone, respectively. The largest values obtained were approximately 1.5°C (2.7°F) for first-trimester fetal tissue and 7°C (12.6°F) for second-trimester fetal bone. Estimated maximum temperature elevations given here are for a “fixed path” tissue model and are for devices having I_{SPTA} values greater than 500 mW/cm². The temperature elevations for fetal bone and tissue were computed based on calculation procedures given in Sections 4.3.2.1-4.3.2.6 in “Bioeffects and Safety of Diagnostic Ultrasound” (AIUM, 1993).

About the Acoustic Output Table

Table 8: Acoustic Output Terms and Definitions

Term	Definition
$I_{SPTA,3}$	Derated spatial peak, temporal average intensity in units of milliwatts/cm ² .
TI type	Applicable thermal index for the transducer, imaging mode, and exam type.
TI value	Thermal index value for the transducer, imaging mode, and exam type.
MI	Mechanical index.
$I_{pa,3}@MI_{max}$	Derated pulse average intensity at the maximum MI in units of W/cm ² .
TIS	(Soft tissue thermal index) is a thermal index related to soft tissues. TIS scan is the soft tissue thermal index in an auto-scanning mode. TIS non-scan is the soft tissue thermal index in the non-autoscanning mode.
TIB	(Bone thermal index) is a thermal index for applications in which the ultrasound beam passes through soft tissue and a focal region is in the immediate vicinity of bone. TIB non-scan is the bone thermal index in the non-autoscanning mode.
TIC	(Cranial bone thermal index) is the thermal index for applications in which the ultrasound beam passes through bone near the beam entrance into the body.
A_{aprt}	Area of the active aperture measured in cm ² .
$P_{r,3}$	Derated peak rarefactional pressure associated with the transmit pattern giving rise to the value reported under MI (Megapascals).
Wo	Ultrasonic power, except for TIS _{scan} , in which case it is the ultrasonic power passing through a one centimeter window in units of milliwatts.
$W_{,3}(z_1)$	Derated ultrasonic power at axial distance z_1 in units of milliwatts.
$I_{SPTA,3}(z_1)$	Derated spatial-peak temporal-average intensity at axial distance z_1 (milliwatts per square centimeter).
z_1	Axial distance corresponding to the location of maximum $[\min(W_{,3}(z), I_{TA,3}(z) \times 1 \text{ cm}^2)]$, where $z \geq z_{bp}$ in centimeters.
z_{bp}	$1.69 \sqrt{(A_{aprt})}$ in centimeters.

Table 8: Acoustic Output Terms and Definitions (Continued)

Term	Definition
z_{sp}	For MI, it is the axial distance at which $p_{r,3}$ is measured. For TIB, it is the axial distance at which TIB is a global maximum (for example, $z_{sp} = z_{b,3}$) in centimeters.
$d_{eq}(z)$	Equivalent beam diameter as a function of axial distance z , and is equal to $\sqrt{(4/\pi)((W_0)/(I_{TA}(z)))}$, where $I_{TA}(z)$ is the temporal-average intensity as a function of z in centimeters.
f_c	Center frequency in MHz.
Dim. of A_{aprt}	Active aperture dimensions for the azimuthal (x) and elevational (y) planes in centimeters.
PD	Pulse duration (microseconds) associated with the transmit pattern giving rise to the reported value of MI.
PRF	Pulse repetition frequency associated with the transmit pattern giving rise to the reported value of MI in Hertz.
$p_r@PII_{max}$	Peak rarefactional pressure at the point where the free-field, spatial-peak pulse intensity integral is a maximum in Megapascals.
$d_{eq}@PII_{max}$	Equivalent beam diameter at the point where the free-field, spatial-peak pulse intensity integral is a maximum in centimeters.
FL	Focal length, or azimuthal (x) and elevational (y) lengths, if different measured in centimeters.

Acoustic Output Tables

Table 9 through Table 44 indicate the acoustic output for the system and transducer combinations with a thermal index or mechanical index equal to or greater than one. These tables are organized by transducer model and imaging mode.

Table 9: Transducer Model: C11e/8-5

Operating Mode: PW Doppler

Index Label		M.I.	TIS			TIB	TIC	
			Scan	Non-scan		Non-scan		
				$A_{aprt} \leq 1$	$A_{aprt} > 1$			
Global Maximum Index Value		(a)	—	(a)	—	1.8	(b)	
Associated Acoustic Parameter	$p_{r,3}$ (MPa)	#						
	W_0 (mW)		—	#		26.29	#	
	min of [$W_{,3}(z_1), I_{TA,3}(z_1)$] (mW)				—			
	z_1 (cm)				—			
	z_{bp} (cm)				—			
	z_{sp} (cm)	#				#		
	$d_{eq}(z_{sp})$ (cm)					#		
	f_c (MHz)	#	—	#	—	4.36	#	
	Dim of A_{aprt}	X (cm)		—	#	—	0.28	#
Y (cm)			—	#	—	0.5	#	
Other Information	PD (μ sec)	#						
	PRF (Hz)	#						
	$p_r@PII_{max}$ (MPa)	#						
	$d_{eq}@PII_{max}$ (cm)					0.226		
	Focal Length	FL _x (cm)		—	#	—		#
		FL _y (cm)		—	#	—		#
$I_{PA,3}@MI_{max}$ (W/cm ²)		#						
Operating Control Conditions	Control 1: Exam Type					Any		
	Control 2: Sample Volume					2mm		
	Control 3: PRF					3906		
	Control 4: Sample Volume Position					Zone 1		

(a) This index is not required for this operating mode; value is <1.

(b) This transducer is not intended for transcranial or neonatal cephalic uses.

No data are reported for this operating condition since the global maximum index value is not reported for the reason listed. (Reference Global Maximum Index Value line.)

— Data are not applicable for this transducer/mode.

Table 10: Transducer Model: C60e/5-2

Operating Mode: 2D

Index Label		M.I.	TIS		TIB	TIC	
			Scan	Non-scan			Non-scan
				$A_{aprt} \leq 1$	$A_{aprt} > 1$		
Global Maximum Index Value		1.0	(a)	—	—	(b)	
Associated Acoustic Parameter	$p_{r,3}$ (MPa)	1.62					
	W_0 (mW)		#	—	—	#	
	min of [$W_{,3}(z_1), I_{TA,3}(z_1)$] (mW)				—		
	z_1 (cm)				—		
	z_{bp} (cm)				—		
	z_{sp} (cm)	4.7			—		
	$d_{eq}(z_{sp})$ (cm)				—		
	f_c (MHz)	2.858	#	—	—	—	#
	Dim of A_{aprt}	X (cm)		#	—	—	—
Y (cm)			#	—	—	—	#
Other Information	PD (μ sec)	0.577					
	PRF (Hz)	7168					
	$p_r@PII_{max}$ (MPa)	2.576					
	$d_{eq}@PII_{max}$ (cm)				—		
	Focal Length	FL_x (cm)		#	—	—	#
		FL_y (cm)		#	—	—	#
$I_{PA,3}@MI_{max}$ (W/cm^2)	184.3						
Operating Control Conditions	Control 1: Exam Type		Any				
	Control 2: Optimization		Pen				
	Control 3: Depth		7.8 cm				
	Control 4: THI		Off				

- (a) This index is not required for this operating mode; value is <1.
- (b) This transducer is not intended for transcranial or neonatal cephalic uses.
- # No data are reported for this operating condition since the global maximum index value is not reported for the reason listed. (Reference Global Maximum Index Value line.)
- Data are not applicable for this transducer/mode.

Table 11: Transducer Model: C60e/5-2

Operating Mode: PW Doppler

Index Label		M.I.	TIS			TIB	TIC	
			Scan	Non-scan		Non-scan		
				$A_{aprt} \leq 1$	$A_{aprt} > 1$			
Global Maximum Index Value		(a)	—	(a)	—	3.1	(b)	
Associated Acoustic Parameter	$p_{r,3}$ (MPa)	#	—	—	—	—	—	
	W_0 (mW)	—	—	#	—	85.64	#	
	min of [$W_{,3}(z_1), I_{TA,3}(z_1)$] (mW)	—	—	—	—	—	—	
	z_1 (cm)	—	—	—	—	—	—	
	z_{bp} (cm)	—	—	—	—	—	—	
	z_{sp} (cm)	#	—	—	—	1.255	—	
	$d_{eq}(z_{sp})$ (cm)	—	—	—	—	0.51	—	
	f_c (MHz)	#	—	#	—	2.233	#	
	Dim of A_{aprt}	X (cm)	—	—	#	—	0.6552	#
Y (cm)		—	—	#	—	1.3	#	
Other Information	PD (μ sec)	#	—	—	—	—	—	
	PRF (Hz)	#	—	—	—	—	—	
	$p_r@PII_{max}$ (MPa)	#	—	—	—	—	—	
	$d_{eq@PII_{max}}$ (cm)	—	—	—	—	0.415	—	
	Focal Length	FL_x (cm)	—	—	#	—	—	#
		FL_y (cm)	—	—	#	—	—	#
$I_{PA,3}@MI_{max}$ (W/cm^2)	#	—	—	—	—	—		
Operating Control Conditions	Control 1: Exam Type		—	—	—	Any	—	
	Control 2: PRF		—	—	—	Any	—	
	Control 3: Sample Volume		—	—	—	12 mm	—	
	Control 4: Sample Volume Position		—	—	—	Zone 1	—	

(a) This index is not required for this operating mode; value is <1.

(b) This transducer is not intended for transcranial or neonatal cephalic uses.

No data are reported for this operating condition since the global maximum index value is not reported for the reason listed. (Reference Global Maximum Index Value line.)

— Data are not applicable for this transducer/mode.

Table 12: Transducer Model: D2/2

Operating Mode: CW

Index Label		M.I.	TIS			TIB	TIC	
			Scan	Non-scan		Non-scan		
				$A_{aprt} \leq 1$	$A_{aprt} > 1$			
Global Maximum Index Value		(a)	—	(a)	—	2.6	(b)	
Associated Acoustic Parameter	$p_{r,3}$ (MPa)	#						
	W_0 (mW)		—	#		90.49	#	
	min of [$W_{,3}(z_1), I_{TA,3}(z_1)$] (mW)				—			
	z_1 (cm)				—			
	z_{bp} (cm)				—			
	z_{sp} (cm)	#				1.1		
	$d_{eq}(z_{sp})$ (cm)					0.66		
	f_c (MHz)	#	—	#	—	2.00	#	
	Dim of A_{aprt}	X (cm)		—	#	—	0.80	#
Y (cm)			—	#	—	0.4	#	
Other Information	PD (μ sec)	#						
	PRF (Hz)	#						
	$p_r@PII_{max}$ (MPa)	#						
	$d_{eq}@PII_{max}$ (cm)					0.54		
	Focal Length	FL_x (cm)		—	#	—		#
		FL_y (cm)		—	#	—		#
$I_{PA,3}@MI_{max}$ (W/cm^2)	#							
Operating Control Conditions	Control 1: Exam Type					Any		
	Control 2: Optimization					Any		
	Control 3: Depth					Any		

(a) This index is not required for this operating mode; value is <1.

(b) This transducer is not intended for transcranial or neonatal cephalic uses.

No data are reported for this operating condition since the global maximum index value is not reported for the reason listed. (Reference Global Maximum Index Value line.)

— Data are not applicable for this transducer/mode.

Table 13: Transducer Model: HFL38/13-6

Operating Mode: CPD/Color

Index Label		M.I.	TIS		TIB	TIC	
			Scan	Non-scan			Non-scan
				A _{aprt} ≤1	A _{aprt} >1		
Global Maximum Index Value		1.1	1.0	—	—	(b)	
Associated Acoustic Parameter	p _{r,3} (MPa)	2.556					
	W ₀ (mW)		53.49	—	—	#	
	min of [W ₃ (z ₁), I _{TA,3} (z ₁)] (mW)				—		
	z ₁ (cm)				—		
	z _{bp} (cm)				—		
	z _{sp} (cm)	1.2				—	
	d _{eq} (z _{sp}) (cm)					—	
	f _c (MHz)	5.328	5.324	—	—	—	#
	Dim of A _{aprt}	X (cm)		0.44	—	—	—
Y (cm)			0.4	—	—	—	#
Other Information	PD (μsec)	0.525					
	PRF (Hz)	2032					
	p _r @P _{II} _{max} (MPa)	3.187					
	d _{eq} @P _{II} _{max} (cm)					—	
	Focal Length	FL _x (cm)		1.32	—	—	#
		FL _y (cm)		2.5	—	—	#
I _{PA,3} @M _I _{max} (W/cm ²)	325.5						
Operating Control Conditions	Control 1: Mode	Color	Color				
	Control 2: Exam Type	Any	Any				
	Control 3: Optimization/Depth/PRF	Low/3.3 cm/401	Med/2.7 cm/1938				
	Control 4: Color Box Position/Size	Any	Top/Short				

(a) This index is not required for this operating mode; value is <1.

(b) This transducer is not intended for transcranial or neonatal cephalic uses.

No data are reported for this operating condition since the global maximum index value is not reported for the reason listed. (Reference Global Maximum Index Value line.)

— Data are not applicable for this transducer/mode.

Table 14: Transducer Model: HFL38/13-6

Operating Mode: PW Doppler

Index Label		M.I.	TIS			TIB	TIC	
			Scan	Non-scan		Non-scan		
				$A_{aprt} \leq 1$	$A_{aprt} > 1$			
Global Maximum Index Value		(a)	—	1.2	—	2.2	(b)	
Associated Acoustic Parameter	$p_{r.3}$ (MPa)	#						
	W_0 (mW)		—	46.55		46.55	#	
	min of [$W_{.3}(z_1), I_{TA,.3}(z_1)$] (mW)				—			
	z_1 (cm)				—			
	z_{bp} (cm)				—			
	z_{sp} (cm)	#				1.1		
	$d_{eq}(z_{sp})$ (cm)					0.33		
	f_c (MHz)	#	—	5.33	—	5.33	#	
	Dim of A_{aprt}	X (cm)		—	1.04	—	1.04	#
Y (cm)			—	0.4	—	0.4	#	
Other Information	PD (μ sec)	#						
	PRF (Hz)	#						
	$p_r@PII_{max}$ (MPa)	#						
	$d_{eq}@PII_{max}$ (cm)					0.46		
	Focal Length	FL_x (cm)		—	3.72	—		#
		FL_y (cm)		—	2.5	—		#
$I_{PA,.3}@MI_{max}$ (W/cm^2)	#							
Operating Control Conditions	Control 1: Exam Type			Vas		Vas		
	Control 2: Sample Volume			12 mm		12 mm		
	Control 3: PRF			10417		10417		
	Control 4: Sample Volume Position			Zone 7		Zone 7		

(a) This index is not required for this operating mode; value is <1.

(b) This transducer is not intended for transcranial or neonatal cephalic uses.

No data are reported for this operating condition since the global maximum index value is not reported for the reason listed. (Reference Global Maximum Index Value line.)

— Data are not applicable for this transducer/mode.

Table 15: Transducer Model: ICT/8-5

Operating Mode: CPD/Color

Index Label		M.I.	TIS			TIB	TIC	
			Scan	Non-scan		Non-scan		
				$A_{aprt} \leq 1$	$A_{aprt} > 1$			
Global Maximum Index Value		(a)	1.0	(a)	—	(a)	1.5	
Associated Acoustic Parameter	$p_{r,3}$ (MPa)	#						
	W_0 (mW)		49.66	#		#	49.66	
	min of [$W_3(z_1), I_{TA,3}(z_1)$] (mW)				—			
	z_1 (cm)				—			
	z_{bp} (cm)				—			
	z_{sp} (cm)	#				#		
	$d_{eq}(z_{sp})$ (cm)					#		
	f_c (MHz)	#	4.36	#	—	#	4.36	
	Dim of A_{aprt}	X (cm)		0.28	#	—	#	0.28
Y (cm)			0.5	#	—	#	0.5	
Other Information	PD (μ sec)	#						
	PRF (Hz)	#						
	$p_r@PII_{max}$ (MPa)	#						
	$d_{eq}@PII_{max}$ (cm)					#		
	Focal Length	FL_x (cm)		1.2	#	—		1.2
		FL_y (cm)		2.5	#	—		2.5
$I_{PA,3}@MI_{max}$	(W/cm^2)	#						
Operating Control Conditions	Control 1: Mode			CPD			CPD	
	Control 2: Exam Type			Any			Any	
	Control 3: Optimization			Med			Med	
	Control 4: Color Box Position/Size			Max depth/ Max width, Min height			Max depth/ Max width, Min height	

(a) This index is not required for this operating mode; value is <1.

(b) This transducer is not intended for transcranial or neonatal cephalic uses.

No data are reported for this operating condition since the global maximum index value is not reported for the reason listed. (Reference Global Maximum Index Value line.)

— Data are not applicable for this transducer/mode.

Table 16: Transducer Model: ICT/8-5

Operating Mode: PW Doppler

Index Label		M.I.	TIS			TIB	TIC	
			Scan	Non-scan		Non-scan		
				$A_{aprt} \leq 1$	$A_{aprt} > 1$			
Global Maximum Index Value		(a)	—	1.0	—	1.8	2.1	
Associated Acoustic Parameter	$p_{r,3}$ (MPa)	#						
	W_0 (mW)		—	49.02		30.07	30.07	
	min of [$W_{,3}(z_1), I_{TA,3}(z_1)$] (mW)				—			
	z_1 (cm)				—			
	z_{bp} (cm)				—			
	z_{sp} (cm)	#				1.1		
	$d_{eq}(z_{sp})$ (cm)					0.31		
	f_c (MHz)	#	—	4.36	—	4.36	4.36	
	Dim of A_{aprt}	X (cm)		—	1.72	—	0.2	0.2
		Y (cm)		—	0.5	—	0.5	0.5
Other Information	PD (μ sec)	#						
	PRF (Hz)	#						
	$p_r@PII_{max}$ (MPa)	#						
	$d_{eq}@PII_{max}$ (cm)					0.27		
	Focal Length	FL_x (cm)		—	6.37	—		0.77
		FL_y (cm)		—	2.5	—		2.5
$I_{PA,3}@MI_{max}$ (W/cm^2)	#							
Operating Control Conditions	Control 1: Exam Type			OB or Gyn		OB or Gyn	OB or Gyn	
	Control 2: Sample Volume			2 mm		2 mm	2 mm	
	Control 3: PRF			≥ 1563		≥ 6250	≥ 6250	
	Control 4: Sample Volume Position			Zone 7 (bottom)		Zone 0 (top)	Zone 0 (top)	

- (a) This index is not required for this operating mode; value is <1.
- (b) This transducer is not intended for transcranial or neonatal cephalic uses.
- # No data are reported for this operating condition since the global maximum index value is not reported for the reason listed. (Reference Global Maximum Index Value line.)
- Data are not applicable for this transducer/mode.

Table 17: Transducer Model L25e/13-6

Operating Mode: PW Doppler

Index Label		M.I.	TIS			TIB	TIC	
			Scan	Non-scan		Non-scan		
				$A_{aprt} \leq 1$	$A_{aprt} > 1$			
Global Maximum Index Value		(a)	—	(a)	—	1.6	(b)	
Associated Acoustic Parameter	$p_{r,3}$ (MPa)	#						
	W_0 (mW)		—	#		14.02	#	
	min of [$W_{,3}(z_1), I_{TA,3}(z_1)$] (mW)				—			
	z_1 (cm)				—			
	z_{bp} (cm)				—			
	z_{sp} (cm)	#				0.6		
	$d_{eq}(z_{sp})$ (cm)					0.155		
	f_c (MHz)	#	—	#	—	6.00	#	
	Dim of A_{aprt}	X (cm)		—	#	—	0.16	#
Y (cm)			—	#	—	0.3	#	
Other Information	PD (μ sec)	#						
	PRF (Hz)	#						
	$p_r@PII_{max}$ (MPa)	#						
	$d_{eq}@PII_{max}$ (cm)					0.1549		
	Focal Length	FL_x (cm)		—	#	—		#
		FL_y (cm)		—	#	—		#
$I_{PA,3}@MI_{max}$ (W/cm^2)		#						
Operating Control Conditions	Control 1: Exam Type					Vas		
	Control 2: Sample Volume					12 mm		
	Control 3: PRF					20833		
	Control 4: Sample Volume Position					Zone 0		

(a) This index is not required for this operating mode; value is <1.

(b) This transducer is not intended for transcranial or neonatal cephalic uses.

No data are reported for this operating condition since the global maximum index value is not reported for the reason listed. (Reference Global Maximum Index Value line.)

— Data are not applicable for this transducer/mode.

Table 18: Transducer Model: L38e/10-5

Operating Mode: 2D

Index Label		M.I.	TIS		TIB	TIC	
			Scan	Non-scan			Non-scan
				$A_{aprt} \leq 1$	$A_{aprt} > 1$		
Global Maximum Index Value		1.5	(a)	—	—	(b)	
Associated Acoustic Parameter	$p_{r,3}$ (MPa)	2.645					
	W_0 (mW)		#	—	—	#	
	min of [$W_{,3}(z_1), I_{TA,3}(z_1)$] (mW)				—		
	z_1 (cm)				—		
	z_{bp} (cm)				—		
	z_{sp} (cm)	1.4				—	
	$d_{eq}(z_{sp})$ (cm)					—	
	f_c (MHz)	5.14	#	—	—	—	#
	Dim of A_{aprt}	X (cm)		#	—	—	—
Y (cm)			#	—	—	—	#
Other Information	PD (μ sec)	0.322					
	PRF (Hz)	7523					
	$p_r@PII_{max}$ (MPa)	3.390					
	$d_{eq}@PII_{max}$ (cm)					—	
	Focal Length	FL_x (cm)		#	—	—	#
		FL_y (cm)		#	—	—	#
$I_{PA,3}@MI_{max}$ (W/cm ²)		427.5					
Operating Control Conditions	Control 1: Exam Type		Any				
	Control 2: Optimization		Pen				
	Control 3: Depth		3.8 cm				

(a) This index is not required for this operating mode; value is <1.

(b) This transducer is not intended for transcranial or neonatal cephalic uses.

No data are reported for this operating condition since the global maximum index value is not reported for the reason listed. (Reference Global Maximum Index Value line.)

— Data are not applicable for this transducer/mode.

Table 19: Transducer Model: L38e/10-5

Operating Mode: M Mode

Index Label		M.I.	TIS			TIB	TIC	
			Scan	Non-scan		Non-scan		
				$A_{aprt} \leq 1$	$A_{aprt} > 1$			
Global Maximum Index Value		1.4	—	(a)	—	1.3	(b)	
Associated Acoustic Parameter	$p_{r,3}$ (MPa)	2.382						
	W_0 (mW)		—	#		21.29	#	
	min of [$W_{,3}(z_1), I_{TA,3}(z_1)$] (mW)				—			
	z_1 (cm)				—			
	z_{bp} (cm)				—			
	z_{sp} (cm)	1.4				1.4		
	$d_{eq}(z_{sp})$ (cm)					0.149		
	f_c (MHz)	5.14	—	#	—	5.14	#	
	Dim of A_{aprt}	X (cm)		—	#	—	0.66	#
Y (cm)			—	#	—	0.4	#	
Other Information	PD (μ sec)	0.322						
	PRF (Hz)	1600						
	$p_r@PII_{max}$ (MPa)	3.05						
	$d_{eq}@PII_{max}$ (cm)					0.148		
	Focal Length	FL _x (cm)		—	#	—		#
		FL _y (cm)		—	#	—		#
$I_{PA,3}@MI_{max}$ (W/cm ²)	385.13							
Operating Control Conditions	Control 1: Exam Type		Any			Any		
	Control 2: Optimization		Pen			Pen		
	Control 3: Depth		3.8 cm			3.8 cm		

(a) This index is not required for this operating mode; value is <1.

(b) This transducer is not intended for transcranial or neonatal cephalic uses.

No data are reported for this operating condition since the global maximum index value is not reported for the reason listed. (Reference Global Maximum Index Value line.)

— Data are not applicable for this transducer/mode.

Table 20: Transducer Model: L38e/10-5

Operating Mode: CPD/Color

Index Label		M.I.	TIS		TIB	TIC		
			Scan	Non-scan			Non-scan	
				$A_{aprt} \leq 1$	$A_{aprt} > 1$			
Global Maximum Index Value		1.5	1.2	—	—	(b)		
Associated Acoustic Parameter	$p_{r,3}$ (MPa)	3.364						
	W_0 (mW)		50.35	—	—	#		
	min of [$W_3(z_1), I_{TA,3}(z_1)$] (mW)				—			
	z_1 (cm)				—			
	z_{bp} (cm)				—			
	z_{sp} (cm)	1.1				—		
	$d_{eq}(z_{sp})$ (cm)					—		
	f_c (MHz)	5.03	5.03	—	—	—	#	
	Dim of A_{aprt}	X (cm)		0.42	—	—	—	#
Y (cm)			0.4	—	—	—	#	
Other Information	PD (μ sec)	1.69						
	PRF (Hz)	4963						
	$p_r@PII_{max}$ (MPa)	3.28						
	$d_{eq}@PII_{max}$ (cm)					—		
	Focal Length	FL_x (cm)		1.5	—	—	—	#
		FL_y (cm)		2.5	—	—	—	#
$I_{PA,3}@MI_{max}$ (W/cm^2)		473.11						
Operating Control Conditions	Control 1: Mode		CPD	Color				
	Control 2: Exam Type		Any	Bre/IMT/Vas				
	Control 3: Optimization/Depth/PRF		Low/3.1 cm/NA	Low/2.0 cm/1453				
	Control 4: Color Box Position/Size		Max depth/Default or max width, Default height	Any				

(a) This index is not required for this operating mode; value is <1.

(b) This transducer is not intended for transcranial or neonatal cephalic uses.

No data are reported for this operating condition since the global maximum index value is not reported for the reason listed. (Reference Global Maximum Index Value line.)

— Data are not applicable for this transducer/mode.

Table 21: Transducer Model: L38e/10-5

Operating Mode: PW Doppler

Index Label		M.I.	TIS			TIB	TIC	
			Scan	Non-scan		Non-scan		
				$A_{aprt} \leq 1$	$A_{aprt} > 1$			
Global Maximum Index Value		1.0	—	1.9	—	2.6	(b)	
Associated Acoustic Parameter	$P_{r,3}$ (MPa)	2.169						
	W_0 (mW)		—	80.347		80.347	#	
	min of [$W_{.3}(z_1), I_{TA,3}(z_1)$] (mW)				—			
	z_1 (cm)				—			
	z_{bp} (cm)				—			
	z_{sp} (cm)	0.9				1.2		
	$d_{eq}(z_{sp})$ (cm)					0.4518		
	f_c (MHz)	5.02	—	5.05	—	5.05	#	
	Dim of A_{aprt}	X (cm)		—	1.86	—	1.86	#
Y (cm)			—	0.4	—	0.4	#	
Other Information	PD (μ sec)	1.27						
	PRF (Hz)	1562.5						
	$p_r@PII_{max}$ (MPa)	2.537						
	$d_{eq}@PII_{max}$ (cm)					0.29		
	Focal Length	FL _x (cm)		—	5.54	—		#
		FL _y (cm)		—	2.5	—		#
$I_{PA,3}@MI_{max}$	(W/cm ²)	201.36						
Operating Control Conditions	Control 1: Exam Type	Bre/SmP/ Vas/IMT		Bre/SmP/ Vas/IMT		Bre/SmP/ Vas/IMT		
	Control 2: Sample Volume	1 mm		3 mm		3 mm		
	Control 3: PRF	1563		≥ 6250		≥ 6250		
	Control 4: Sample Volume Position	Zone 0 (top)		Zone 7 (bottom)		Zone 7 (bottom)		

(a) This index is not required for this operating mode; value is <1.

(b) This transducer is not intended for transcranial or neonatal cephalic uses.

No data are reported for this operating condition since the global maximum index value is not reported for the reason listed. (Reference Global Maximum Index Value line.)

— Data are not applicable for this transducer/mode.

Table 22: Transducer Model: P10/8-4

Operating Mode: 2D

Index Label		M.I.	TIS		TIB	TIC	
			Scan	Non-scan			Non-scan
				$A_{aprt} \leq 1$	$A_{aprt} > 1$		
Global Maximum Index Value		1.0	(a)	—	—	(b)	
Associated Acoustic Parameter	$p_{r,3}$ (MPa)	2.043					
	W_0 (mW)		#	—	—	#	
	min of [$W_{,3}(z_1), I_{TA,3}(z_1)$] (mW)				—		
	z_1 (cm)				—		
	z_{bp} (cm)				—		
	z_{sp} (cm)	2.3				—	
	$d_{eq}(z_{sp})$ (cm)					—	
	f_c (MHz)	4.297	#	—	—	—	#
	Dim of A_{aprt}	X (cm)		#	—	—	—
Y (cm)			#	—	—	—	#
Other Information	PD (μ sec)	0.390					
	PRF (Hz)	6400					
	$p_r@PII_{max}$ (MPa)	2.89					
	$d_{eq}@PII_{max}$ (cm)					—	
	Focal Length	FL_x (cm)		#	—	—	#
		FL_y (cm)		#	—	—	#
$I_{PA,3}@MI_{max}$ (W/cm^2)	244.0						
Operating Control Conditions	Control 1: Exam Type		Card				
	Control 2: Optimization		Pen				
	Control 3: Depth		4.4 cm				
	Control 4: THI		Off				

- (a) This index is not required for this operating mode; value is <1.
- (b) This transducer is not intended for transcranial or neonatal cephalic uses.
- # No data are reported for this operating condition since the global maximum index value is not reported for the reason listed. (Reference Global Maximum Index Value line.)
- Data are not applicable for this transducer/mode.

Table 23: Transducer Model: P10/8-4

Operating Mode: M Mode

Index Label		M.I.	TIS			TIB	TIC	
			Scan	Non-scan		Non-scan		
				$A_{aprt} \leq 1$	$A_{aprt} > 1$			
Global Maximum Index Value		1.1	—	(a)	—	(a)	(a)	
Associated Acoustic Parameter	$p_{r,3}$ (MPa)	2.26						
	W_0 (mW)		—	#		#	#	
	min of [$W_{,3}(z_1), I_{TA,3}(z_1)$] (mW)				—			
	z_1 (cm)				—			
	z_{bp} (cm)				—			
	z_{sp} (cm)	2.3				#		
	$d_{eq}(z_{sp})$ (cm)					#		
	f_c (MHz)	4.297	—	#	—	#	#	
	Dim of A_{aprt}	X (cm)		—	#	—	#	#
Y (cm)			—	#	—	#	#	
Other Information	PD (μ sec)	0.392						
	PRF (Hz)	800						
	$p_r@PII_{max}$ (MPa)	3.176						
	$d_{eq}@PII_{max}$ (cm)					#		
	Focal Length	FL_x (cm)		—	#	—		#
		FL_y (cm)		—	#	—		#
$I_{PA,3}@MI_{max}$ (W/cm ²)	298.6							
Operating Control Conditions	Control 1: Exam Type		Any					
	Control 2: Optimization		Pen					
	Control 3: Depth		4.4 cm					

(a) This index is not required for this operating mode; value is <1.

(b) This transducer is not intended for transcranial or neonatal cephalic uses.

No data are reported for this operating condition since the global maximum index value is not reported for the reason listed. (Reference Global Maximum Index Value line.)

— Data are not applicable for this transducer/mode.

Table 24: Transducer Model: P10/8-4

Operating Mode: CPD/Color

Index Label		M.I.	TIS			TIB	TIC	
			Scan	Non-scan		Non-scan		
				A _{aprt} ≤1	A _{aprt} >1			
Global Maximum Index Value		(a)	1.3	—	—	—	(b)	
Associated Acoustic Parameter	p _{r,3} (MPa)	#						
	W ₀ (mW)		60.98	—		—	#	
	min of [W ₃ (z ₁), I _{TA,3} (z ₁)] (mW)				—			
	z ₁ (cm)				—			
	z _{bp} (cm)				—			
	z _{sp} (cm)	#				—		
	d _{eq} (z _{sp}) (cm)					—		
	f _c (MHz)	#	4.30	—	—	—	#	
	Dim of A _{aprt}	X (cm)		0.992	—	—	—	#
Y (cm)			0.7	—	—	—	#	
Other Information	PD (μsec)	#						
	PRF (Hz)	#						
	p _r @P _{II} _{max} (MPa)	#						
	d _{eq} @P _{II} _{max} (cm)					—		
	Focal Length	FL _x (cm)		5.06	—	—		#
		FL _y (cm)		5.0	—	—		#
I _{PA,3} @M _I _{max} (W/cm ²)	#							
Operating Control Conditions	Control 1: Mode		Color					
	Control 2: Exam Type		Any					
	Control 3: Optimization/Depth		Low/6.8 cm					
	Control 4: Color Box Size		Narrow					

- (a) This index is not required for this operating mode; value is <1.
- (b) This transducer is not intended for transcranial or neonatal cephalic uses.
- # No data are reported for this operating condition since the global maximum index value is not reported for the reason listed. (Reference Global Maximum Index Value line.)
- Data are not applicable for this transducer/mode.

Table 25: Transducer Model: P10/8-4

Operating Mode: PW

Index Label		M.I.	TIS			TIB	TIC	
			Scan	Non-scan		Non-scan		
				$A_{aprt} \leq 1$	$A_{aprt} > 1$			
Global Maximum Index Value		1.05	—	1.4	—	2.7	(b)	
Associated Acoustic Parameter	$p_{r,3}$ (MPa)	2.196						
	W_0 (mW)		—	66.76		47.32	#	
	min of [$W_{,3}(z_1), I_{TA,3}(z_1)$] (mW)				—			
	z_1 (cm)				—			
	z_{bp} (cm)				—			
	z_{sp} (cm)	0.8				0.8		
	$d_{eq}(z_{sp})$ (cm)					0.295		
	f_c (MHz)	4.37	—	4.36	—	4.36	#	
	Dim of A_{aprt}	X (cm)		—	0.992	—	0.384	#
Y (cm)			—	0.7	—	0.7	#	
Other Information	PD (μ sec)	1.31						
	PRF (Hz)	1562						
	$p_r@PII_{max}$ (MPa)	2.48						
	$d_{eq}@PII_{max}$ (cm)					0.267		
	Focal Length	FL_x (cm)		—	6.77	—		#
		FL_y (cm)		—	5.0	—		#
$I_{PA,3}@MI_{max}$ (W/cm ²)	186.99							
Operating Control Conditions	Control 1: Exam Type	Card		Vas/Neo/ Abd		Vas/Neo/ Abd		
	Control 2: Sample Volume	1 mm		10 mm		12 mm		
	Control 3: PRF	1563		≥ 5208		15625		
	Control 4: Sample Volume Position	Zone 1		Zone 7		Zone 1		

(a) This index is not required for this operating mode; value is <1.

(b) This transducer is not intended for transcranial or neonatal cephalic uses.

No data are reported for this operating condition since the global maximum index value is not reported for the reason listed. (Reference Global Maximum Index Value line.)

— Data are not applicable for this transducer/mode.

Table 26: Transducer Model: P10/8-4

Operating Mode: CW

Index Label		M.I.	TIS			TIB	TIC	
			Scan	Non-scan		Non-scan		
				$A_{aprt} \leq 1$	$A_{aprt} > 1$			
Global Maximum Index Value		(a)	—	(a)	—	2.1	(b)	
Associated Acoustic Parameter	$p_{r,3}$ (MPa)	#						
	W_0 (mW)		—	#		40.82	#	
	min of [$W_{,3}(z_1), I_{TA,3}(z_1)$]				—			
	z_1 (cm)				—			
	z_{bp} (cm)				—			
	z_{sp} (cm)	#				0.7		
	$d_{eq}(z_{sp})$ (cm)					0.34		
	f_c (MHz)	#	—	#	—	4.00	#	
	Dim of A_{aprt}	X (cm)		—	#	—	0.32	#
		Y (cm)		—	#	—	0.7	#
Other Information	PD (μ sec)	#						
	PRF (Hz)	#						
	$p_r@PII_{max}$ (MPa)	#						
	$d_{eq}@PII_{max}$ (cm)					0.27		
	Focal Length	FL_x (cm)		—	#	—		#
		FL_y (cm)		—	#	—		#
$I_{PA,3}@MI_{max}$ (W/cm^2)	#							
Operating Control Conditions	Control 1: Exam Type					Card		
	Control 2: Zone					Zone 1		

- (a) This index is not required for this operating mode; value is <1.
- (b) This transducer is not intended for transcranial or neonatal cephalic uses.
- # No data are reported for this operating condition since the global maximum index value is not reported for the reason listed. (Reference Global Maximum Index Value line.)
- Data are not applicable for this transducer/mode.

Table 27: Transducer Model: P17/5-1

Operating Mode: 2D

Index Label		M.I.	TIS			TIB	TIC	
			Scan	Non-scan		Non-scan		
				$A_{aprt} \leq 1$	$A_{aprt} > 1$			
Global Maximum Index Value		(a)	(a)	—	—	—	1.7	
Associated Acoustic Parameter	$p_{r,3}$ (MPa)	#						
	W_0 (mW)		#	—		—	110.43	
	min of [$W_{,3}(z_1), I_{TA,3}(z_1)$] (mW)				—			
	z_1 (cm)				—			
	z_{bp} (cm)				—			
	z_{sp} (cm)	#				—		
	$d_{eq}(z_{sp})$ (cm)					—		
	f_c (MHz)	#	#	—	—	—	2.09	
	Dim of A_{aprt}	X (cm)		#	—	—	—	0.5294
	Y (cm)		#	—	—	—	1.3	
Other Information	PD (μ sec)	#						
	PRF (Hz)	#						
	$p_r@PII_{max}$ (MPa)	#						
	$d_{eq}@PII_{max}$ (cm)					—		
	Focal Length	FL _x (cm)		#	—	—		1.55
		FL _y (cm)		#	—	—		7.0
	$I_{PA,3}@MI_{max}$ (W/cm ²)	#						
Operating Control Conditions	Control 1: Exam Type						OB	
	Control 2: Optimization						Any	
	Control 3: Depth						4.7	
	Control 4: THI						On	

(a) This index is not required for this operating mode; value is <1.

(b) This transducer is not intended for transcranial or neonatal cephalic uses.

No data are reported for this operating condition since the global maximum index value is not reported for the reason listed. (Reference Global Maximum Index Value line.)

— Data are not applicable for this transducer/mode.

Table 28: Transducer Model: P17/5-1

Operating Mode: M Mode

Index Label		M.I.	TIS		TIB	TIC		
			Scan	Non-scan			Non-scan	
				$A_{aprt} \leq 1$	$A_{aprt} > 1$			
Global Maximum Index Value		1.1	—	(a)	—	(a)	—	
Associated Acoustic Parameter	$p_{r,3}$ (MPa)	1.612						
	W_0 (mW)		—	#		#	—	
	min of [$W_{,3}(z_1), I_{TA,3}(z_1)$] (mW)				—			
	z_1 (cm)				—			
	z_{bp} (cm)				—			
	z_{sp} (cm)	3.8				#		
	$d_{eq}(z_{sp})$ (cm)					#		
	f_c (MHz)	2.10	—	#	—	#	—	
	Dim of A_{aprt}	X (cm)		—	#	—	#	—
		Y (cm)		—	#	—	#	—
Other Information	PD (μ sec)	0.824						
	PRF (Hz)	800						
	$p_r@PII_{max}$ (MPa)	2.127						
	$d_{eq}@PII_{max}$ (cm)					#		
	Focal Length	FL_x (cm)		—	#	—		—
		FL_y (cm)		—	#	—		—
$I_{PA,3}@MI_{max}$ (W/cm ²)	126.3							
Operating Control Conditions	Control 1: Exam Type		Abd & OB					
	Control 2: Optimization		ANY					
	Control 3: Depth		7.5 cm					
	Control 4: THI		On					

- (a) This index is not required for this operating mode; value is <1.
- (b) This transducer is not intended for transcranial or neonatal cephalic uses.
- # No data are reported for this operating condition since the global maximum index value is not reported for the reason listed. (Reference Global Maximum Index Value line.)
- Data are not applicable for this transducer/mode.

Table 29: Transducer Model: P17/5-1

Operating Mode: CPD/Color

Index Label		M.I.	TIS			TIB	TIC	
			Scan	Non-scan		Non-scan		
				A _{aprt} ≤1	A _{aprt} >1			
Global Maximum Index Value		1.1	1.0	—	—	—	2.2	
Associated Acoustic Parameter	P _{r,3} (MPa)	1.612						
	W ₀ (mW)		100.83	—		—	92.91	
	min of [W ₃ (z ₁), I _{TA,3} (z ₁)] (mW)				—			
	z ₁ (cm)				—			
	z _{bp} (cm)				—			
	z _{sp} (cm)	3.8				—		
	d _{eq} (z _{sp}) (cm)					—		
	f _c (MHz)	2.10	2.21	—	—	—	2.19	
	Dim of A _{aprt}	X (cm)		0.9	—	—	—	0.424
Y (cm)			1.3	—	—	—	1.3	
Other Information	PD (μsec)	0.824						
	PRF (Hz)	1005						
	p _r @P _{II} _{max} (MPa)	2.127						
	d _{eq} @P _{II} _{max} (cm)					—		
	Focal Length	FL _x (cm)		3.68	—	—		1.55
		FL _y (cm)		7.0	—	—		7.0
I _{PA,3} @M _I _{max} (W/cm ²)		126.3						
Operating Control Conditions	Control 1: Mode	Color	Color				Color	
	Control 2: Exam Type	Abd & OB	TCD				TCD	
	Control 3: Optimization/Depth/PRF	Low/7.5 cm/300	Low/7.5 cm/Any				Low/4.7 cm/Any	
	Control 4: THI	On	—				—	
Control 5: Color Box Position/Size	Any	Top/Narrow				Top/Narrow		

- (a) This index is not required for this operating mode; value is <1.
- (b) This transducer is not intended for transcranial or neonatal cephalic uses.
- # No data are reported for this operating condition since the global maximum index value is not reported for the reason listed. (Reference Global Maximum Index Value line.)
- Data are not applicable for this transducer/mode.

Safety

Table 30: Transducer Model: P17/5-1

Operating Mode: PW Doppler

Index Label		M.I.	TIS		TIB	TIC		
			Scan	Non-scan			Non-scan	
				$A_{aprt} \leq 1$	$A_{aprt} > 1$			
Global Maximum Index Value		1.1	—	—	1.2	3.5	2.5	
Associated Acoustic Parameter	$p_{r,3}$ (MPa)	1.853						
	W_0 (mW)		—	—		83.41	83.41	
	min of [$W_{,3}(z_1), I_{TA,3}(z_1)$] (mW)				103.6			
	z_1 (cm)				1.9			
	z_{bp} (cm)				1.82			
	z_{sp} (cm)	4.9				1.7		
	$d_{eq}(z_{sp})$ (cm)					0.6		
	f_c (MHz)	2.20	—	—	3.67	2.23	2.23	
	Dim of A_{aprt}	X (cm)		—	—	0.90	0.424	0.424
Y (cm)			—	—	1.3	1.3	1.3	
Other Information	PD (μ sec)	1.17						
	PRF (Hz)	1562.5						
	$p_r@PII_{max}$ (MPa)	2.339						
	$d_{eq}@PII_{max}$ (cm)					0.46		
	Focal Length	FL_x (cm)		—	—	3.43		1.55
		FL_y (cm)		—	—	7.0		7.0
$I_{PA,3}@MI_{max}$ (W/cm ²)	164.0							
Operating Control Conditions	Control 1: Exam Type	Card			Card	Abd or OB	Abd or OB	
	Control 2: Sample Volume	1 mm			3 mm	3 mm	3 mm	
	Control 3: PRF	1563			≥ 1563	Any	Any	
	Control 4: Sample Volume Position	Zone 3			Zone 1	Zone 0	Zone 0	
	Control 5: TDI				On			

(a) This index is not required for this operating mode; value is <1.

(b) This transducer is not intended for transcranial or neonatal cephalic uses.

No data are reported for this operating condition since the global maximum index value is not reported for the reason listed. (Reference Global Maximum Index Value line.)

— Data are not applicable for this transducer/mode.

Table 31: Transducer Model: P17/5-1

Operating Mode: CW

Index Label		M.I.	TIS			TIB	TIC	
			Scan	Non-scan		Non-scan		
				$A_{aprt} \leq 1$	$A_{aprt} > 1$			
Global Maximum Index Value		(a)	—	(a)	1.0	3.6	2.6	
Associated Acoustic Parameter	$p_{r,3}$ (MPa)	#						
	W_0 (mW)		—	#		120.60	121.23	
	min of [$W_{,3}(z_1), I_{TA,3}(z_1)$] (mW)				—			
	z_1 (cm)				—			
	z_{bp} (cm)				—			
	z_{sp} (cm)	#				1.4		
	$d_{eq}(z_{sp})$ (cm)					0.63		
	f_c (MHz)	#	—	—	2.00	2.00	2.00	
	Dim of A_{aprt}	X (cm)		—	—	0.85	0.85	0.85
	Y (cm)		—	—	1.3	1.3	1.3	
Other Information	PD (μ sec)	#						
	PRF (Hz)	#						
	$p_r@PII_{max}$ (MPa)	#						
	$d_{eq}@PII_{max}$ (cm)					.50		
	Focal Length	FL _x (cm)		—	—	—		#
		FL _y (cm)		—	—	7.0		7.0
	$I_{PA,3}@MI_{max}$ (W/cm ²)	#						
Operating Control Conditions	Control 1: Exam Type					Card	Card	Card
	Control 2: Depth					Any	Any	Any
	Control 3: Zone					Zone 2	Zone 2	Zones 3 & 4

- (a) This index is not required for this operating mode; value is <1.
- (b) This transducer is not intended for transcranial or neonatal cephalic uses.
- # No data are reported for this operating condition since the global maximum index value is not reported for the reason listed. (Reference Global Maximum Index Value line.)
- Data are not applicable for this transducer/mode.

Safety

Table 32: Transducer Model: SLA/13-6

Operating Mode: 2D

Index Label		M.I.	TIS		TIB	TIC	
			Scan	Non-scan			Non-scan
				$A_{aprt} \leq 1$	$A_{aprt} > 1$		
Global Maximum Index Value		1.0	(a)	—	—	(a)	
Associated Acoustic Parameter	$p_{r,3}$ (MPa)	2.475					
	W_0 (mW)		#	—	—	#	
	min of [$W_{,3}(z_1), I_{TA,3}(z_1)$] (mW)				—		
	z_1 (cm)				—		
	z_{bp} (cm)				—		
	z_{sp} (cm)	0.85			—		
	$d_{eq}(z_{sp})$ (cm)				—		
	f_c (MHz)	6.45	#	—	—	—	#
	Dim of A_{aprt}	X (cm)		#	—	—	—
Y (cm)			#	—	—	—	#
Other Information	PD (μ sec)	0.274					
	PRF (Hz)	14336					
	$p_r@PII_{max}$ (MPa)	2.991					
	$d_{eq}@PII_{max}$ (cm)				—		
	Focal Length	FL_x (cm)		#	—	—	#
		FL_y (cm)		#	—	—	#
$I_{PA,3}@MI_{max}$ (W/cm^2)	331.4						
Operating Control Conditions	Control 1: Exam Type		Any				
	Control 2: Optimization		Pen				
	Control 3: Depth		1.9 cm				

- (a) This index is not required for this operating mode; value is <1.
- (b) This transducer is not intended for transcranial or neonatal cephalic uses.
- # No data are reported for this operating condition since the global maximum index value is not reported for the reason listed. (Reference Global Maximum Index Value line.)
- Data are not applicable for this transducer/mode.

Table 33: Transducer Model: SLA/13-6

Operating Mode: M Mode

Index Label		M.I.	TIS		TIB	TIC	
			Scan	Non-scan			Non-scan
				$A_{aprt} \leq 1$	$A_{aprt} > 1$		
Global Maximum Index Value		1.0	—	(a)	—	(a)	
Associated Acoustic Parameter	$p_{r,3}$ (MPa)	1.692					
	W_0 (mW)		—	#		#	
	min of [$W_{,3}(z_1), I_{TA,3}(z_1)$] (mW)				—		
	z_1 (cm)				—		
	z_{bp} (cm)				—		
	z_{sp} (cm)	0.85				—	
	$d_{eq}(z_{sp})$ (cm)					—	
	f_c (MHz)	6.45	—	#	—	—	#
	Dim of A_{aprt}	X (cm)		—	#	—	—
Y (cm)			—	#	—	—	#
Other Information	PD (μ sec)	0.274					
	PRF (Hz)	14336					
	$p_r@PII_{max}$ (MPa)	2.991					
	$d_{eq}@PII_{max}$ (cm)					—	
	Focal Length	FL _x (cm)		—	#	—	#
		FL _y (cm)		—	#	—	#
$I_{PA,3}@MI_{max}$ (W/cm ²)	331.4						
Operating Control Conditions	Control 1: Exam Type		Any				
	Control 2: Optimization		Pen				
	Control 3: Depth		1.9 cm				

(a) This index is not required for this operating mode; value is <1.

(b) This transducer is not intended for transcranial or neonatal cephalic uses.

No data are reported for this operating condition since the global maximum index value is not reported for the reason listed. (Reference Global Maximum Index Value line.)

— Data are not applicable for this transducer/mode.

Table 34: Transducer Model: SLA/13-6

Operating Mode: CPD/Color

Index Label		M.I.	TIS			TIB	TIC	
			Scan	Non-scan		Non-scan		
				A _{aprt} ≤1	A _{aprt} >1			
Global Maximum Index Value		1.04	—	—	—	—	(b)	
Associated Acoustic Parameter	P _{r,3} (MPa)	2.547						
	W ₀ (mW)		—	—		—	#	
	min of [W ₃ (z ₁), I _{TA,3} (z ₁)] (mW)				—			
	z ₁ (cm)				—			
	z _{bp} (cm)				—			
	z _{sp} (cm)	0.7				—		
	d _{eq} (z _{sp}) (cm)					—		
	f _c (MHz)	6.0	—	—	—	—	#	
	Dim of A _{aprt}	X (cm)		—	—	—	—	#
Y (cm)			—	—	—	—	#	
Other Information	PD (μsec)	1.89						
	PRF (Hz)	2340						
	p _r @PII _{max} (MPa)	2.675						
	d _{eq} @PII _{max} (cm)					—		
	Focal Length	FL _x (cm)		—	—	—		#
		FL _y (cm)		—	—	—		#
I _{PA,3} @MI _{max} (W/cm ²)	308.1							
Operating Control Conditions	Control 1: Exam Type		Mus or Sup					
	Control 2: Optimization		Low					
	Control 3: Depth		2.6 cm					
	Control 4: Color Box Position/Size		Bottom/Max width, Max height					

(a) This index is not required for this operating mode; value is <1.

(b) This transducer is not intended for transcranial or neonatal cephalic uses.

No data are reported for this operating condition since the global maximum index value is not reported for the reason listed. (Reference Global Maximum Index Value line.)

— Data are not applicable for this transducer/mode.

Table 35: Transducer Model: SLA/13-6

Operating Mode: PW Doppler

Index Label		M.I.	TIS			TIB	TIC	
			Scan	Non-scan		Non-scan		
				$A_{aprt} \leq 1$	$A_{aprt} > 1$			
Global Maximum Index Value		(a)	—	(a)	—	1.2	(b)	
Associated Acoustic Parameter	$p_{r,3}$ (MPa)	#						
	W_0 (mW)		—	#		16.83	#	
	min of [$W_{,3}(z_1), I_{TA,3}(z_1)$] (mW)				—			
	z_1 (cm)				—			
	z_{bp} (cm)				—			
	z_{sp} (cm)	#				1.4		
	$d_{eq}(z_{sp})$ (cm)					0.25		
	f_c (MHz)	#	—	#	—	6.00	#	
	Dim of A_{aprt}	X (cm)		—	#	—	0.52	#
Y (cm)			—	#	—	0.3	#	
Other Information	PD (μ sec)	#						
	PRF (Hz)	#						
	$p_r@PII_{max}$ (MPa)	#						
	$d_{eq}@PII_{max}$ (cm)					0.172		
	Focal Length	FL_x (cm)		—	#	—		#
		FL_y (cm)		—	#	—		#
$I_{PA,3}@MI_{max}$ (W/cm^2)		#						
Operating Control Conditions	Control 1: Exam Type					Sup & Mus		
	Control 2: Sample Volume					2 mm		
	Control 3: PRF					≤ 15625		
	Control 4: Sample Volume Position					Zone 0 through 6		

(a) This index is not required for this operating mode; value is <1.

(b) This transducer is not intended for transcranial or neonatal cephalic uses.

No data are reported for this operating condition since the global maximum index value is not reported for the reason listed. (Reference Global Maximum Index Value line.)

— Data are not applicable for this transducer/mode.

Table 36: Transducer Model: SLT/10-5

Operating Mode: 2D

Index Label		M.I.	TIS		TIB	TIC	
			Scan	Non-scan			Non-scan
				$A_{aprt} \leq 1$	$A_{aprt} > 1$		
Global Maximum Index Value		1.0	(a)	—	—	(a)	
Associated Acoustic Parameter	$p_{r,3}$ (MPa)	2.475					
	W_0 (mW)		#	—	—	#	
	min of [$W_{,3}(z_1), I_{TA,3}(z_1)$] (mW)				—		
	z_1 (cm)				—		
	z_{bp} (cm)				—		
	z_{sp} (cm)	1.8			—		
	$d_{eq}(z_{sp})$ (cm)				—		
	f_c (MHz)	4.39	#	—	—	—	#
	Dim of A_{aprt}	X (cm)		#	—	—	—
Y (cm)			#	—	—	—	#
Other Information	PD (μ sec)	0.50					
	PRF (Hz)	6633					
	$p_r@PII_{max}$ (MPa)	2.871					
	$d_{eq}@PII_{max}$ (cm)				—		
	Focal Length	FL_x (cm)		#	—	—	#
		FL_y (cm)		#	—	—	#
$I_{PA,3}@MI_{max}$ (W/cm^2)	253.3						
Operating Control Conditions	Control 1: Exam Type		Any				
	Control 2: Optimization		Pen				
	Control 3: Depth		4.5 cm				

- (a) This index is not required for this operating mode; value is <1.
- (b) This transducer is not intended for transcranial or neonatal cephalic uses.
- # No data are reported for this operating condition since the global maximum index value is not reported for the reason listed. (Reference Global Maximum Index Value line.)
- Data are not applicable for this transducer/mode.

Table 37: Transducer Model: SLT/10-5

Operating Mode: M Mode

Index Label		M.I.	TIS			TIB	TIC	
			Scan	Non-scan		Non-scan		
				$A_{aprt} \leq 1$	$A_{aprt} > 1$			
Global Maximum Index Value		1.0	(a)	—	—	1.4	(a)	
Associated Acoustic Parameter	$p_{r,3}$ (MPa)	2.475						
	W_0 (mW)		#	—		24.86	#	
	min of [$W_{,3}(z_1), I_{TA,3}(z_1)$] (mW)				—			
	z_1 (cm)				—			
	z_{bp} (cm)				—			
	z_{sp} (cm)	1.8				1.7		
	$d_{eq}(z_{sp})$ (cm)					0.200		
	f_c (MHz)	4.39	#	—	—	4.39	#	
	Dim of A_{aprt}	X (cm)		#	—	—	0.658	#
Y (cm)			#	—	—	0.55	#	
Other Information	PD (μ sec)	0.50						
	PRF (Hz)	1600						
	$p_r@PII_{max}$ (MPa)	2.871						
	$d_{eq}@PII_{max}$ (cm)					0.1952		
	Focal Length	FL _x (cm)		#	—	—		#
		FL _y (cm)		#	—	—		#
$I_{PA,3}@MI_{max}$ (W/cm ²)	253.3							
Operating Control Conditions	Control 1: Exam Type	Any				Any		
	Control 2: Optimization	Pen				Pen		
	Control 3: Depth	4.5 cm				4.5 cm		

(a) This index is not required for this operating mode; value is <1.

(b) This transducer is not intended for transcranial or neonatal cephalic uses.

No data are reported for this operating condition since the global maximum index value is not reported for the reason listed. (Reference Global Maximum Index Value line.)

— Data are not applicable for this transducer/mode.

Table 38: Transducer Model: SLT/10-5

Operating Mode: CPD/Color

Index Label		M.I.	TIS			TIB	TIC	
			Scan	Non-scan		Non-scan		
				A _{aprt} ≤1	A _{aprt} >1			
Global Maximum Index Value		1.2	—	—	—	—	(b)	
Associated Acoustic Parameter	p _{r,3} (MPa)	2.386	—	—	—	—		
	W ₀ (mW)		—	—	—	—	#	
	min of [W ₃ (z ₁), I _{TA,3} (z ₁)] (mW)				—			
	z ₁ (cm)				—			
	z _{bp} (cm)				—			
	z _{sp} (cm)	1.7				—		
	d _{eq} (z _{sp}) (cm)					—		
	f _c (MHz)	4.18	—	—	—	—	#	
	Dim of A _{aprt}	X (cm)		—	—	—	—	#
Y (cm)			—	—	—	—	#	
Other Information	PD (μsec)	1.80						
	PRF (Hz)	2471						
	p _r @PII _{max} (MPa)	3.05						
	d _{eq} @PII _{max} (cm)					—		
	Focal Length	FL _x (cm)		—	—	—		#
		FL _y (cm)		—	—	—		#
I _{PA,3} @MI _{max} (W/cm ²)	354.5							
Operating Control Conditions	Control 1: Exam Type		Any					
	Control 2: Optimization		Any					
	Control 3: Depth		4.5 cm					
	Control 4: PRF		401 Hz					
	Control 5: Color Box Position/Size		Default position/ Default width					

(a) This index is not required for this operating mode; value is <1.

(b) This transducer is not intended for transcranial or neonatal cephalic uses.

No data are reported for this operating condition since the global maximum index value is not reported for the reason listed. (Reference Global Maximum Index Value line.)

— Data are not applicable for this transducer/mode.

Table 39: Transducer Model: SLT/10-5

Operating Mode: PW

Index Label		M.I.	TIS			TIB	TIC	
			Scan	Non-scan		Non-scan		
				$A_{aprt} \leq 1$	$A_{aprt} > 1$			
Global Maximum Index Value		(a)	—	1.2	—	2.1	(b)	
Associated Acoustic Parameter	$p_{r,3}$ (MPa)	#						
	W_0 (mW)		—	61.20		38.51	#	
	min of [$W_{,3}(z_1), I_{TA,3}(z_1)$] (mW)				—			
	z_1 (cm)				—			
	z_{bp} (cm)				—			
	z_{sp} (cm)	#				1.4		
	$d_{eq}(z_{sp})$ (cm)					0.24		
	f_c (MHz)	#	—	4.18	—	4.18	#	
	Dim of A_{aprt}	X (cm)		—	1.646	—	0.329	#
	Y (cm)		—	0.55	—	0.55	#	
Other Information	PD (μ sec)	#						
	PRF (Hz)	#						
	$p_r@PII_{max}$ (MPa)	#						
	$d_{eq}@PII_{max}$ (cm)					0.24		
	Focal Length	FL _x (cm)		—	6.46	—		#
		FL _y (cm)		—	3.0	—		#
	$I_{PA,3}@MI_{max}$ (W/cm ²)	#						
Operating Control Conditions	Control 1: Exam Type				Any		Any	
	Control 2: Sample Volume				3 mm		10 mm	
	Control 3: PRF				5208		15625 & 20833	
	Control 4: Sample Volume Position				Zone 7		Zone 0	

(a) This index is not required for this operating mode; value is <1.

(b) This transducer is not intended for transcranial or neonatal cephalic uses.

No data are reported for this operating condition since the global maximum index value is not reported for the reason listed. (Reference Global Maximum Index Value line.)

— Data are not applicable for this transducer/mode.

Table 40: Transducer Model: TEE/8-3

Operating Mode: 2D

Index Label		M.I.	TIS			TIB	TIC	
			Scan	Non-scan		Non-scan		
				$A_{aprt} \leq 1$	$A_{aprt} > 1$			
Global Maximum Index Value		(a)	1.0	—	—	—	(b)	
Associated Acoustic Parameter	$p_{r,3}$ (MPa)	#						
	W_0 (mW)		54.91	—		—	#	
	min of [$W_{,3}(z_1), I_{TA,3}(z_1)$] (mW)				—			
	z_1 (cm)				—			
	z_{bp} (cm)				—			
	z_{sp} (cm)	#				—		
	$d_{eq}(z_{sp})$ (cm)					—		
	f_c (MHz)	#	3.97	—	—	—	#	
	Dim of A_{aprt}	X (cm)		0.812	—	—	—	#
Y (cm)			0.9	—	—	—	#	
Other Information	PD (μ sec)	#						
	PRF (Hz)	#						
	$p_r@PII_{max}$ (MPa)	#						
	$d_{eq}@PII_{max}$ (cm)					—		
	Focal Length	FL_x (cm)		3.61	—	—		#
		FL_y (cm)		4.75	—	—		#
$I_{PA,3}@MI_{max}$ (W/cm^2)	#							
Operating Control Conditions	Control 1: Exam Type		Card					
	Control 2: Optimization		Pen					
	Control 3: Depth		4.0 cm					

(a) This index is not required for this operating mode; value is <1.

(b) This transducer is not intended for transcranial or neonatal cephalic uses.

No data are reported for this operating condition since the global maximum index value is not reported for the reason listed. (Reference Global Maximum Index Value line.)

— Data are not applicable for this transducer/mode.

Table 41: Transducer Model: TEE/8-3

Operating Mode: CW

Index Label		M.I.	TIS			TIB	TIC	
			Scan	Non-scan		Non-scan		
				$A_{aprt} \leq 1$	$A_{aprt} > 1$			
Global Maximum Index Value		(a)	—	1.1	—	2.3	(b)	
Associated Acoustic Parameter	$p_{r,3}$ (MPa)	#						
	W_0 (mW)		—	55.67		54.47	#	
	min of [$W_3(z_1), I_{TA,3}(z_1)$] (mW)				—			
	z_1 (cm)				—			
	z_{bp} (cm)				—			
	z_{sp} (cm)	#				1.1		
	$d_{eq}(z_{sp})$ (cm)					0.39		
	f_c (MHz)	#	—	4.00	—	4.00	#	
	Dim of A_{aprt}	X (cm)		—	0.435	—	0.435	#
	Y (cm)		—	0.9	—	0.9	#	
Other Information	PD (μ sec)	#						
	PRF (Hz)	#						
	$p_r@PII_{max}$ (MPa)	#						
	$d_{eq}@PII_{max}$ (cm)					0.34		
	Focal Length	FL _x (cm)		—	4.45	—		#
		FL _y (cm)		—	4.75	—		#
	$I_{PA,3}@MI_{max}$ (W/cm ²)	#						
Operating Control Conditions	Control 1: Exam Type			Card		Card		
	Control 4: Sample Volume Position			Zone 3		Zone 2		

(a) This index is not required for this operating mode; value is <1.

(b) This transducer is not intended for transcranial or neonatal cephalic uses.

No data are reported for this operating condition since the global maximum index value is not reported for the reason listed. (Reference Global Maximum Index Value line.)

— Data are not applicable for this transducer/mode.

Table 42: Transducer Model: TEE/8-3

Operating Mode: M Mode

Index Label		M.I.	TIS		TIB	TIC		
			Scan	Non-scan			Non-scan	
				$A_{aprt} \leq 1$	$A_{aprt} > 1$			
Global Maximum Index Value		1.3	—	(a)	—	(a)		
Associated Acoustic Parameter	$p_{r,3}$ (MPa)	2.04						
	W_0 (mW)		—	#		#		
	min of [$W_{,3}(z_1), I_{TA,3}(z_1)$]	(mW)			—			
	z_1 (cm)				—			
	z_{bp} (cm)				—			
	z_{sp} (cm)	2.61				#		
	$d_{eq}(z_{sp})$ (cm)					#		
	f_c (MHz)	3.97	—	#	—	#	#	
	Dim of A_{aprt}	X (cm)		—	#	—	#	#
		Y (cm)		—	#	—	#	#
Other Information	PD (μ sec)	0.558						
	PRF (Hz)	800						
	$p_r@PII_{max}$ (MPa)	2.915						
	$d_{eq}@PII_{max}$ (cm)					#		
	Focal Length	FL_x (cm)		—	#	—	#	
		FL_y (cm)		—	#	—	#	
	$I_{PA,3}@MI_{max}$ (W/cm ²)	176.61						
Operating Control Conditions	Control 1: Exam Type		Card					
	Control 2: Optimization		Pen					
	Control 3: Depth		4.0 cm					

- (a) This index is not required for this operating mode; value is <1.
- (b) This transducer is not intended for transcranial or neonatal cephalic uses.
- # No data are reported for this operating condition since the global maximum index value is not reported for the reason listed. (Reference Global Maximum Index Value line.)
- Data are not applicable for this transducer/mode.

Table 43: Transducer Model: TEE/8-3

Operating Mode: PW Doppler

Index Label		M.I.	TIS			TIB	TIC	
			Scan	Non-scan		Non-scan		
				$A_{aprt} \leq 1$	$A_{aprt} > 1$			
Global Maximum Index Value		(a)	—	1.3	—	2.8	(b)	
Associated Acoustic Parameter	$p_{r,3}$ (MPa)	#						
	W_0 (mW)		—	73.15		58.10	#	
	min of [$W_3(z_1), I_{TA,3}(z_1)$] (mW)				—			
	z_1 (cm)				—			
	z_{bp} (cm)				—			
	z_{sp} (cm)	#				1.1		
	$d_{eq}(z_{sp})$ (cm)					0.5321		
	f_c (MHz)	#	—	3.81	—	3.82	#	
	Dim of A_{aprt}	X (cm)		—	0.9	—	0.9	#
	Y (cm)		—	0.9	—	0.9	#	
Other Information	PD (μ sec)	#						
	PRF (Hz)	#						
	$p_r@PII_{max}$ (MPa)	#						
	$d_{eq}@PII_{max}$ (cm)					0.320		
	Focal Length	FL _x (cm)		—	8.83	—		#
		FL _y (cm)		—	4.75	—		#
	$I_{PA,3}@MI_{max}$ (W/cm ²)	#						
Operating Control Conditions	Control 1: Exam Type			Card		Card		
	Control 2: Sample Volume			1 mm		1 mm		
	Control 3: PRF			1563		1563		
	Control 4: Sample Volume Position			Zone 6		Zone 1		

(a) This index is not required for this operating mode; value is <1.

(b) This transducer is not intended for transcranial or neonatal cephalic uses.

No data are reported for this operating condition since the global maximum index value is not reported for the reason listed. (Reference Global Maximum Index Value line.)

— Data are not applicable for this transducer/mode.

Table 44: Transducer Model: TEE/8-3

Operating Mode: Color

Index Label		M.I.	TIS			TIB	TIC	
			Scan	Non-scan		Non-scan		
				$A_{aprt} \leq 1$	$A_{aprt} > 1$			
Global Maximum Index Value		(a)	1.3	—	—	—	(b)	
Associated Acoustic Parameter	$p_{r,3}$ (MPa)	#						
	W_0 (mW)		72.66	—		—	#	
	min of [$W_{,3}(z_1), I_{TA,3}(z_1)$] (mW)				—			
	z_1 (cm)				—			
	z_{bp} (cm)				—			
	z_{sp} (cm)	#				—		
	$d_{eq}(z_{sp})$ (cm)					—		
	f_c (MHz)	#	3.82	—	—	—	#	
	Dim of A_{aprt}	X (cm)		0.9	—	—	—	#
Y (cm)			0.9	—	—	—	#	
Other Information	PD (μ sec)	#						
	PRF (Hz)	#						
	$p_r@PII_{max}$ (MPa)	#						
	$d_{eq}@PII_{max}$ (cm)					—		
	Focal Length	FL_x (cm)		11.78	—	—		#
		FL_y (cm)		4.75	—	—		#
$I_{PA,3}@MI_{max}$ (W/cm^2)	#							
Operating Control Conditions	Control 1: Mode		Color					
	Control 2: Exam Type		Card					
	Control 3: Optimization/Depth/PRF		Any/ 14cm/ 4386 Hz					
	Control 4: Color Box Position/Size		Any					

- (a) This index is not required for this operating mode; value is <1.
- (b) This transducer is not intended for transcranial or neonatal cephalic uses.
- # No data are reported for this operating condition since the global maximum index value is not reported for the reason listed. (Reference Global Maximum Index Value line.)
- Data are not applicable for this transducer/mode.

Acoustic Measurement Precision and Uncertainty

All table entries have been obtained at the same operating conditions that give rise to the maximum index value in the first column of the table. Measurement precision and uncertainty for power, pressure, intensity, and other quantities that are used to derive the values in the acoustic output table are shown in the table below. In accordance with Section 6.4 of the Output Display Standard, the following measurement precision and uncertainty values are determined by making repeat measurements and stating the standard deviation as a percentage.

Table 45: Acoustic Measurement Precision and Uncertainty

Quantity	Precision (% of standard deviation)	Uncertainty (95% confidence)
Pr	1.9%	±11.2%
Pr ₃	1.9%	±12.2%
Wo	3.4%	±10%
fc	0.1%	±4.7%
Pll	3.2%	+12.5 to -16.8%
Pll ₃	3.2%	+13.47 to -17.5%

Labeling Symbols

The following symbols are found on the products, packaging, and containers.

Table 46: Labeling Symbols





Symbol	Definition
	Alternating Current (AC)
	Affixed to a Class 1 device indicating manufacturer's declaration of conformance with Annex VII of 93/42/EEC.
	Affixed to a Class 1 device requiring verification by the Notified Body of sterilization or measurement features, or to a Class IIa, IIb, or III device requiring verification or auditing by the Notified Body to applicable Annex(es) of 93/42/EEC.
	Attention, see the User Guide

Table 46: Labeling Symbols (Continued)





















Symbol	Definition
	Device complies with relevant Australian regulations for electronic devices.
	Batch code, date code, or lot code type of control number
	Biological risk
	Device complies with relevant Brazilian regulations for electro-medical devices.
	Canadian Standards Association
	Catalog number
	Collect separately from other household waste (see European Commission Directive 93/86/EEC). Refer to local regulations for disposal.
	Contents sterilized using ethylene oxide process.
	Corrugated recycle
	Dangerous voltage
	Date of manufacture
	Direct Current (DC)
	Do not get wet

Table 46: Labeling Symbols (Continued)

Symbol	Definition
	Do not stack over 2 high
	Do not stack over 5 high
	Do not stack over 10 high
	Electrostatic sensitive devices
	Device complies with relevant FCC regulations for electronic devices.
	Fragile
	Gel sterilized by radiation.
	Hot
	Indoor use only
	Device emits a static (DC) magnetic field.
	Non-ionizing radiation
	Paper recycle

Table 46: Labeling Symbols (Continued)

Symbol	Definition
	Serial number type of control number
	Storage temperature conditions
IPX7	Submersible. Protected against the effects of temporary immersion.
IPX8	Water-Tight Equipment. Protected against the effects of extended immersion.
Mobile Docking System Input: 100 - 240V ~ 50 - 60Hz 4 - 2A	
	Handle transducer with care
	Follow manufacturer's instructions for disinfecting time
	Disinfect transducer
	Type BF patient applied part (B = body, F = floating applied part)
	Underwriter's Laboratories labeling
	Pollution Control Logo. (China only) Applies to all parts/products listed in the China RoHS disclosure table. This logo may not appear on the exterior of some parts/products due to space limitations.
WARNING: Connect Only Accessories and Peripherals Recommended by SonoSite to Convenience Receptacles.	

Glossary

This glossary includes an alphanumeric listing of terms.

The American Institute of Ultrasound in Medicine (AIUM) has published *Recommended Ultrasound Terminology, Second Edition*, 1997. Refer to it for ultrasound terms not contained in this glossary.

Terms

2D (two-dimensional) image	A way to display echoes in two dimensions on a video display. Video pixels are assigned a brightness level based on echo signal amplitude. See also CPD image and Color Doppler (Color) image.
as low as reasonably achievable (ALARA)	The guiding principle of ultrasound use, which states that you should keep patient exposure to ultrasound energy as low as reasonably achievable for diagnostic results.
color power Doppler (CPD) image	A Doppler imaging mode used to visualize the presence of detectable blood flow. See also 2D image, and Color image.
color Doppler (Color) image	A Doppler imaging mode used to visualize the presence, velocity, and direction of blood flow in a wide range of flow states. See 2D image and CPD image.
color suppress	A way to hide or show color information while still in color Doppler mode.
continuous wave (CW) Doppler mode	A Doppler recording of blood flow velocities along the length of the beam.
curved array transducer	Identified by the letter C (curved or curvilinear) and a number (60). The number corresponds to the radius of curvature of the array expressed in millimeters. The transducer elements are electrically configured to control the characteristics and direction of the acoustic beam. For example, C15, C60e.
depth	A menu item used to adjust the depth of the display. A constant speed of sound of 1538.5 meters/second is assumed in the calculation of echo position in the image.
<i>in situ</i>	In the natural or original position.

linear array transducer	Identified by the letter L (linear) and a number (38). The number corresponds to the radius of width of the array expressed in millimeters. The transducer elements are electrically configured to control the characteristics and direction of the acoustic beam. For example, L38.
M Mode	Motion Mode showing the phasic motions of the cardiac structures. A single beam of ultrasound is transmitted and reflected signals are displayed as dots of varying intensities, which create lines across the screen.
mechanical index (MI)	An indication of the likelihood of mechanical bioeffects occurring: the higher the MI, the greater the likelihood of mechanical bioeffects. See Chapter 9, "Safety" for a more complete description of MI.
MI/TI	See mechanical index and thermal index.
NTSC	National Television Standards Committee. A video format setting. See also PAL.
PAL	Phase Alternating Line. A video format setting. See also NTSC.
phased array	A transducer designed primarily for cardiac scanning. Forms a sector image by electronically steering the beam direction and focus.
pulsed wave (PW) Doppler mode	A Doppler recording of blood flow velocities in a range specific area along the length of the beam.
skinline	A depth on the display that corresponds to the skin/transducer interface.
SonoMB	A subset of the 2D imaging mode, where the 2D image is enhanced by looking at a target from three angles and then merging or averaging the scanned data together to improve overall image quality and, in parallel, reducing noise and artifacts.
SonoRES	A subset of 2D imaging mode where the 2D image is enhanced by reducing speckle noise artifact at tissue margins and improving contrast resolution by reducing artifacts and improving visualization of texture patterns within the image.
Tissue Doppler Imaging (TDI)	A pulsed wave Doppler technique used to detect myocardial motion.
thermal index (TI)	The ratio of total acoustic power to the acoustic power required to raise tissue temperature by 1°C under defined assumptions. See "Chapter 9, "Safety" for a more complete description of TI.

TIB (bone thermal index)

A thermal index for applications in which the ultrasound beam passes through soft tissue and a focal region is in the immediate vicinity of bone.

TIC (cranial bone thermal index)

A thermal index for applications in which the ultrasound beam passes through bone near the beam entrance into the body.

TIS (soft tissue thermal index)

A thermal index related to soft tissues.

Tissue Harmonic Imaging

Transmits at one frequency and receives at a higher harmonic frequency to reduce noise and clutter and improve resolution.

transducer

A device that transforms one form of energy into another form of energy. Ultrasound transducers contain piezoelectric elements, which when excited electrically, emit acoustic energy. When the acoustic energy is transmitted into the body, it travels until it encounters an interface, or change in tissue properties. At the interface, an echo is formed that returns to the transducer, where this acoustic energy is transformed into electrical energy, processed, and displayed as anatomical information.

variance

Displays a variation in Color Doppler flow imaging within a given sample. Variance is mapped to the color green and is used to detect turbulence

Acronyms

Acronyms used in the user interface are listed below.

Table 1: Acronyms

Acronym	Description
+/x	"+" Caliper/"x" Caliper Ratio
A	"A" Wave Peak Velocity
A PG	"A" Wave Peak Pressure Gradient
A2Cd	Apical 2 Chamber diastolic
A2Cs	Apical 2 Chamber systolic
A4Cd	Apical 4 Chamber diastolic
A4Cs	Apical 4 Chamber systolic
AAo	Ascending Aorta

Table 1: Acronyms (Continued)

Acronym	Description
abs	Absolute value
AC	Abdominal Circumference
ACA	Anterior Cerebral Artery
ACC	Acceleration Index
ACoA	Anterior Communicating Artery
ACS	Aortic Valve Cusp Separation
AFI	Amniotic Fluid Index
AI	Aortic Insufficiency
AI PHT	Aortic Insufficiency Pressure Half Time
AL	Atlas Loop
Ann D	Annulus Diameter
ANT F	Anterior Far
ANT N	Anterior Near
Ao	Aorta
AoD	Aortic Root Diameter
Apical	Apical View
APTD	Anteroposterior Trunk Diameter
AT	Acceleration (Deceleration) Time
AUA	Average Ultrasound Age
AV	Aortic Valve
AV Area	Aortic Valve Area
AVA	Aortic Valve Area
BA	Basilar Artery
BPD	Biparietal Diameter
BPM	Beats per Minute

Table 1: Acronyms (Continued)

Acronym	Description
Bifur	Bifurcation
CCA	Common Carotid Artery
CO	Cardiac Output
CI	Cardiac Index
CPD	Color Power Doppler
CRL	Crown Rump Length
CW	Continuous Wave Doppler
D	Diameter
D Apical	Distance Apical
DCCA	Distal Common Carotid Artery
DECA	Distal External Carotid Artery
DICA	Distal Internal Carotid Artery
Dist	Distal
dP:dT	Delta Pressure: Delta Time
E	"E" Wave Peak Velocity
E PG	"E" Wave Peak Pressure Gradient
E:A	E:A Ratio
ECA	External Carotid Artery
ECG	Electrocardiogram
ECICA	Extracranial Internal Carotid Artery
ECVA	Extracranial Vertebral Artery
EDD	Estimated Date of Delivery
EDD by AUA	Estimated Date of Delivery by Average Ultrasound Age
EDD by LMP	Estimated Date of Delivery by Last Menstrual Period
EDV	End Diastolic Velocity

Table 1: Acronyms (Continued)

Acronym	Description
E/e'	E velocity = Mitral Valve E velocity divided by the annular e' velocity
EF	Ejection Fraction
EF:SLOPE	E-F Slope
EFW	Estimated Fetal Weight
Endo	Endocardial
Epi	Epicardial
EPSS	"E" Point Septal Separation
Estab. DD	Established Due Date
ET	Elapsed Time
FH	Femoral Head
FHR	Fetal Heart Rate
FL	Femur Length
FM (Right and Left)	Foramen Magnum (same as SO)
FTA	Fetal Trunk Area
GA	Gestational Age
GA by LMP	Gestational Age by Last Menstrual Period
GA by LMPd	Gestational Age by derived Last Menstrual Period
Gate	Depth of Doppler Gate
GS	Gestational Sac
HC	Head Circumference
HR	Heart Rate
ICA	Internal Carotid Artery
IMT	Intima Media Thickness
IVRT	Iso Volumic Relaxation Time
IVS	Interventricular Septum

Table 1: Acronyms (Continued)

Acronym	Description
IVSd	Interventricular Septum Diastolic
IVSFT	Interventricular Septum Fractional Shortening
IVSs	Interventricular Septum Systolic
LA	Left Atrium
LA/Ao	Left Atrium/Aorta Ratio
LAT F	Lateral Far
LAT N	Lateral Near
LMP	Last Menstrual Period
LMPd	derived Last Menstrual Period
LVO	Left Ventricular Opacification
LV	Left Ventricular
LV Area	Left Ventricular Area
LV mass	Left Ventricular mass
LV Volume	Left Ventricular Volume
LVD	Left Ventricular diastolic
LVD	Left Ventricular Dimension
LVDd	Left Ventricular Dimension Diastolic
LVDfS	Left Ventricular Dimension Fractional Shortening
LVDs	Left Ventricular Dimension Systolic
LVEDV	Left Ventricular End Diastolic Volume
LVESV	Left Ventricular End Systolic Volume
LVET	Left Ventricular Ejection Time
LVOT	Left Ventricular Outflow Tract
LVOT Area	Left Ventricular Outflow Tract Area
LVOT D	Left Ventricular Outflow Tract Diameter

Table 1: Acronyms (Continued)

Acronym	Description
LVOT VTI	Left Ventricular Outflow Tract Velocity Time Integral
LVPW	Left Ventricular Posterior Wall
LVPWd	Left Ventricular Posterior Wall Diastolic
LVPWFT	Left Ventricular Posterior Wall Fractional Thickening
LVPWs	Left Ventricular Posterior Wall Systolic
LVs	Left Ventricular systolic
MB	SonoMB
MCA	Middle Cerebral Artery
MCCA	Mid Common Carotid Artery
MECA	Mid External Carotid Artery
MI	Mechanical Index
MICA	Mid Internal Carotid Artery
Mid	Middle
MM	M Mode
MR PISA	Mitral Regurgitation Proximal Iso Velocity Surface Area
MR/VTI	Mitral Regurgitation/Velocity Time Integral
MV	Mitral Valve
MV Area	Mitral Valve Area
MV ERO	Mitral Valve Effective Regurgitant Orifice
MV PISA Area	Mitral Valve Proximal Iso Velocity Surface Area
MV Rate	Mitral Valve Rate
MV Regurgitant Fraction	Mitral Valve Regurgitant Fraction
MV Regurgitant Volume	Mitral Valve Regurgitant Volume
MVA	Mitral Valve Area
MV/VTI	Mitral Valve/Velocity Time Integral

Table 1: Acronyms (Continued)

Acronym	Description
NTSC	National Television Standards Committee
OA	Ophthalmic Artery
OFD	Occipital Frontal Diameter
PAL	Phase Alternating Line
PCAp1 PCAp2	Posterior Cerebral Artery Peak
PCCA	Proximal Common Carotid Artery
PCoA	Posterior Communicating Artery
PECA	Proximal External Carotid Artery
PGr	Pressure Gradient
PGmax	Maximum Pressure Gradient
PGmean	Mean Pressure Gradient
PHT	Pressure Half Time
PI	Pulsatility Index
PICA	Proximal Internal Carotid Artery
PISA	Proximal Isovelocity Surface Area
Plaq 1 Plaq 2	Plaque
POST F	Posterior Far
POST N	Posterior Near
Prox	Proximal
PSV	Peak Systolic Velocity
PV	Pulmonic Valve
PW	Pulsed Wave Doppler
Qp/Qs	Pulmonary blood flow divided by systemic blood flow
RA	Right Atrial (pressure)

Table 1: Acronyms (Continued)

Acronym	Description
RI	Resistive Index
RVD	Right Ventricular Dimension
RVDd	Right Ventricular Dimension Diastolic
RVDs	Right Ventricular Dimension Systolic
RVOT D	Right Ventricular Outflow Tract Diameter
RVOT VTI	Right Ventricular Outflow Tract Velocity Time Integral
RVSP	Right Ventricular Systolic Pressure
RVW	Right Ventricular Free Wall
RVWd	Right Ventricular Free Wall Diastolic
RVWs	Right Ventricular Free Wall Systolic
S	SonoRES
S/D	Systolic/Diastolic Ratio
SI	Stroke Index
Siphon	Siphon (internal carotid artery)
SM	Submandibular
SO	Suboccipital
SV	Stroke Volume
TAM	Time Average Mean
TAP	Time Average Peak
TDI	Tissue Doppler Imaging
TEE	Transesophageal Echocardiogram
THI	Tissue Harmonic Imaging
TI	Thermal Index
TICA	Terminal Internal Carotid Artery
TO	Transorbital

Table 1: Acronyms (Continued)

Acronym	Description
TRmax	Tricuspid Regurgitation (peak velocity)
TT	Transtemporal
TTD	Transverse Trunk Diameter
TV	Tricuspid Valve
UA	Ultrasound Age
Umb A	Umbilical Artery
VA	Vertebral Artery
VArty	Vertebral Artery
Vmax	Peak Velocity
Vmean	Mean Velocity
Vol	Volume
VF	Volume Flow
VTI	Velocity Time Integral

Index

Symbols

+/x measurement 86

Numerics

2D imaging 57, 287
2D measurements 79

A

a' 126
abbreviations, exam type 52
abdominal, intended uses 1
AC power indicator 17
acceleration (ACC) index measurement 86
accessories list 220
acoustic measurement precision 283
acoustic output
 measurement 243
 tables 245, 246–282
acquisition error 203
acronyms 289
add new user 27
administrator login 25
age, gestational 102
airborne equipment standards 223
ALARA principle 235, 287
alphanumeric 16
angle correction 66
annotation
 annotate images 74
 arrow 75
 description 16
 home 75
 label 75
 set home 74
 set up 36
aorta (Ao) 121
aortic valve area (AVA) 130
archive, patient list 72
area/circumference measurement 81
arrow 75
ascending aorta (AAo) 121
assistance, customer 4

B

bar code scanner 78
baseline 67
battery
 clean 192
 install 12
 remove 12
 safety 228
 specifications 221, 222
 storage and shipping 221
biological safety 230
biopsy 58
b-mode *See* 2D imaging
bodymarker *See* pictograph
brightness 58
brightness mode *See* 2D imaging

C

cable
 clean and disinfect transducer cables 190
 specifications 221
calcs menu 19
calculations
 authors 102
 cardiac 117
 delete measurement 89
 gyn 96
 IMT 110
 OB 100
 OB Doppler 107
 percent reduction 90
 perform measurements 89
 small parts 96
 vascular 108
 view or repeat measurements 89
 volume 93
 volume flow 94
caliper/calcs 17
cardiac calculations
 2D and M Mode 118
 AAo 121
 Ao 121
 AVA 130
 CI 133
 CO 133

- Doppler 124, 126
- dP:dT 130
- E, A, and VMax 126
- e' and a' 126
- HR 133
- IVRT 124
- LA 121
- LV mass 123
- LV volume (Simpson's Rule) 122
- LVd 121
- LVOT D 121
- LVs 121
- MV/AV area 122
- PHT 128
- PISA 119
- Qp/Qs 119
- RVSP 127
- SI 132
- SV 132
- TDI 134
- TRmax 126
- VTI 127
- cardiac index (CI) 133
- cardiac output (CO) 133
- cardiac references 204
- cardiac, intended uses 1
- cautions, definition 225
- CF capacity alert 34
- cine buffer 60
- cleaning
 - battery 192
 - ECG cable 192
 - footswitch 192
 - LCD screen 187
 - system 187
 - transducer cables 190
 - transducers 188
- clip
 - acquisition delay 69
 - delete 69
 - preview 68
 - review 72
 - save 68
 - setup 68
 - storage 70
 - trim 69
- color Doppler imaging 63
- color power Doppler imaging *See* color Doppler imaging
- color suppress 63

- CompactFlash
 - capacity alert 34
 - install 12
 - remove 13
- configuration
 - archivers 154
 - DICOM 147
 - import and export 165
 - network log 166
 - printers 157
 - procedure 164
 - SiteLink 141
 - worklist servers 161
- continuous wave Doppler (CW)
 - D-line 65
 - spectral trace 67
- controls
 - direct 236
 - indirect 236
 - menu 21
 - receiver 236
- CW Doppler imaging
 - definition 287

D

- d:D ratio 96
- date 35
- default settings, change to 47
- delta key 36
- delta pressure:delta time (dP:dT) 130
- depth
 - adjust 59
 - definition 287
 - description 17
- depth marker 20
- deselect, patient list 72
- DICOM
 - archive image 170
 - backup 147
 - configuration 147
 - connectivity 34
 - location 149
 - manual archive image 171
 - patient information 171
 - patient query 173
 - print image 170
 - select archiver 168
 - select location 168
 - select printer 168

- select worklist server 168
- sort worklist 173
- standard 223
- system setup 148
- usage 167
- verify archiver status 168
- verify image transfer 171
- verify printer status 168
- verify worklist server status 168
- worklist 173
- DICOM wireless 152
- disinfectants
 - compatibility table 193–198
 - safety 186
- disinfecting
 - battery 192
 - ECG cable 192
 - system 187
 - transducer cables 190
 - transducers 188
- distance measurement
 - 2D 80
 - M mode 83
- D-line
 - PW Doppler 65
- Doppler
 - color 63
 - CW 65
 - Doppler amplitude mode *See* CPD imaging
 - Doppler gate depth 66
 - Doppler scale 45
 - PW 65
- dual images 58
- duplex images 45
- DVD
 - problem 176
 - setup 33

E

- E, A, and VMax, TRmax 126
- e' 126
- e' and a' 126
- ECG
 - monitoring 76
 - turn on 59
- elapsed time (ET) measurement 86
- electrical
 - safety 226
 - specifications 222

- electromagnetic compatibility 230
- electromechanical safety standards 222
- EMC classification standards 223
- EMED Worksheets 140
- end exam 51
- energy mode *See* CPD imaging
- enter text 74
- equipment safety 228
- ergonomic safety 9
- error message 227
- errors
 - acquisition 203
 - algorithmic 203
 - measurement 203
- estimated date of delivery (EDD) 210
- estimated fetal weight (EFW) 211
- event log 29
- exam type
 - abbreviations 52
 - transducer 53
- export user account 28

F

- far, description 17
- fetal age, inaccurate calculation 176
- fetal heart rate (FHR) 84
- flow sensitivity 64
- focal zones, optimize 57
- follicle measurement 99
- footswitch 46, 77
- forms 18
- freeze
 - description 18
 - turn on/off 60

G

- gain
 - adjust 59
 - description 17
- gate size 66
- gel 56
- grace period 177
- guidance documents, related 241
- gynecological (gyn) calculations 98
- gynecology, intended uses 2

H

heart rate (HR) 84, 133
hip angle 96
humidity limits 221

I

image
 problem 175
 review 72
 save to CompactFlash 71
image mode
 2D
 color Doppler 63
 M Mode 61
 PW and CW Doppler 65
 transducer 53
image storage specifications 220
imaging, CW Doppler 287
import user account 28
IMT
 calculations 110
 sketch 113
 trace 111
in situ definition 287
infertility, intended uses 2
intended uses 1–3
intensity
 derated 243
 in situ 243
 water-value 243
interventional, intended uses 2
Intima Media Thickness (IMT) calculations 110
intraoperative, intended uses 2
invert
 CPD 64
 Doppler 67
iso volumic relaxation time (IVRT) 124

L

labeling symbols 283
LCD screen
 clean 187
 output 240
 specifications 219
left atrium (LA) 121
left ventricular diastolic (LVd) 121
left ventricular mass (LV mass) 123
left ventricular outflow tract diameter (LVOT D) 121

left ventricular systolic (LVs) 121
left ventricular volume (LV volume) 122
license key 184, 185
live trace 45, 67
login 25, 26, 30
LVO(Left Ventricular Opacification) 58

M

M mode
 M-line 61
 trace 62
maintenance 186
manual trace 82, 87
measurement
 area/circumference 81
 delete 82
 distance 80, 83
 follicle 99
 heart rate 84
 terminology, publications 203
 vascular 108
measurement accuracy
 2D measurements 201
 caliper placement 201
 display size 201
measurement and calcs data 19
measurements and calculations
 cardiac, Doppler calculations 124
mechanical index (MI) 240, 288
menu controls 21
mitral valve/aortic valve (MV/AV) 122
M-line
 M Mode 61
mode data 19, 38
modes 18

N

near, description 17
network log 166
new patient 49
NTSC, definition 288

O

OB
 calculations 100, 105
 Doppler calculations 107
 graphs 139

- table set up 43
- obstetrical references 210
- obstetrical, intended uses 2
- on-screen controls 17
- on-screen menu 19, 21
- optimize 57
- orbital 117
- orientation marker 19
- output display 240

P

- PAL, definition 288
- pan 60
- password 26, 28, 30
- patient header 20, 38
- patient images
 - delete 73
 - next or previous 73
 - patient list 73
 - turn on 73
- patient information
 - DICOM 171
 - new patient 49
- patient list
 - archive 72
 - delete 73
 - print all images 73
 - review images 72
 - turn on 72
- patient report
 - cardiac 136
 - general 135
 - OB twins 137
 - transcranial 137
 - vascular 136
- PC setup 33
- peak velocity (VMax) 126
- pediatric, intended uses 3
- percent area reduction 91
- percent diameter reduction 91
- percent reduction calculation 90
- peripherals 221
- pictograph 19, 76
- power 16
- precision, acoustic measurement 283
- pressure half time (PHT) 128
- pressure limits 221
- PRF setting 67
- print all images 73

- print image 17, 72
- printer
 - DICOM configuration 157
 - problem 176
 - setup 33
- probe *See* transducer
- procedure, configuration 164
- prostate, intended uses 3
- proximal isovelocity surface area (PISA) 119
- pulsed wave Doppler (PW)
 - D-line 65
 - spectral trace 67

Q

- Qp/Qs 119

R

- recording problem 176
- references
 - cardiac 204
 - general 216
 - obstetrical 210
- reports, patient 135
- resistive index (RI) measurement 86
- review images 72
- right ventricular systolic pressure (RVSP) 127
- ROI box 63

S

- safety
 - battery 228
 - biological 230
 - disinfectants 186
 - electrical 226
 - electromagnetic compatibility 230
 - equipment 228
 - ergonomic 9
- save clip 71
- save image 17, 71
- save key 46
- scale 67
- scanhead *See* transducer
- screen layout
 - calcs menu 19
 - depth marker 20
 - measurement and calcs data 19
 - mode data 19

- on-screen menu 19
- orientation marker 19
- patient header 20
- picto 19
- system status 20
- text 19
- security setup 25
- select 17
- select all, patient list 72
- serial port 33
- shipping specifications 221
- Simpson's Rule 122
- SiteLink
 - configuration 141
 - connectivity 34
 - wireless 144
- skin line, definition 288
- small parts calculations 96
- software
 - DICOM 148
 - license 177
 - upgrade 178
- SonoMB 59, 288
- SonoRES 58, 288
- special characters 23
- specifications 219
- spectral trace 67
- standards
 - airborne equipment 223
 - DICOM 223
 - electromechanical 222
 - EMC classification 223
- steering
 - CPD 64
 - Doppler 66
- sterilizable transducers 190
- storage specifications, equipment 221
- stroke index (SI) 132
- stroke volume (SV) 132
- superficial, intended uses 3
- symbols 23
- symbols, labeling 283
- system
 - clean and disinfect 187
 - software 8
 - specifications 221
 - storage and shipping 221
 - turn on/off 14
 - upgrade software 177
 - wake up 14

- system control
 - AC power indicator 17
 - alphanumeric 16
 - annotation 16
 - caliper/calcs 17
 - depth 17
 - far 17
 - forms 18
 - freeze 18
 - gain 17
 - modes 18
 - near 17
 - on-screen controls 17
 - power 16
 - print 17
 - save 17
 - select 17
 - THI 16
 - touchpad 17
 - update 18
 - video recording 18
 - zoom 17
- system dimensions 219
- system setup
 - annotations 36
 - beep alert 31
 - cardiac calculation 32
 - date 35
 - delta key 36
 - description 24
 - DICOM 148
 - Doppler scale 45
 - duplex images 45
 - export OB tables 40
 - footswitch 46
 - gestational age 40
 - growth analysis 40
 - import OB tables 41
 - IMT calculations 39
 - key click 31
 - live trace 45
 - mode data 38
 - OB custom measurement 42
 - patient header 38
 - power delay 31
 - printer 33
 - save key 46
 - security 25
 - serial port 33
 - sleep delay 31

- system information 47
- system status 38, 48
- thermal index 45
- time 35
- transfer mode 34
- video mode 33
- system status 20, 38

T

- temperature limits 221
- text
 - description 19
 - enter 74
 - entry problems 176
- thermal index (TI) 45, 240, 288
- THI
 - description 16
 - turn on/off 59
- time 35
- tissue Doppler imaging (TDI) 66, 134
- tissue models 244
- touchpad 17, 20
- trace calculations
 - automatic 87
 - manual 87
- transcranial Doppler (TCD) 116
- transcranial, intended uses 3
- transducer
 - cables, clean and disinfect 190
 - clean and disinfect 188
 - connect 15
 - curved array 287
 - definition 289
 - disinfect 188
 - exam type 53, 90, 92, 94, 97, 100, 108, 110, 114, 117
 - general use 56
 - imaging modes 53
 - invasive or surgical use 56
 - linear array 288
 - preparation 55
 - problems 176
 - remove 15
 - sheath 56
 - specifications 219, 222
 - sterilizable 190
 - storage and shipping 222
 - upgrade software 177
- transorbital (TO) 117

- tricuspid regurgitation (TRmax) 126
- troubleshooting 175

U

- ultrasound, terminology 287
- unfreeze text 37
- update 18
- upgrade system software 177
- upgrade transducer software 177
- user account 28
- user guide, conventions used 4
- user login 26
- user, add 27
- uses, intended 1–3

V

- variance 64
- vascular
 - calculations 108
 - intended uses 3
- VCR
 - problem 176
 - setup 33
- velocity measurement 86
- velocity time integral (VTI) 127
- video mode 33
- video recording 18
- volume
 - adjust Doppler volume 67
 - calculation 92, 93
- volume flow 94

W

- wall filter 64, 67
- warnings, definition 225
- wireless
 - DICOM 152
 - SiteLink 144
- worklist servers, configuration 161
- worksheets 140

Z

- zoom
 - description 17
 - pan 60
 - turn on/off 60

Screen Layout



- 1 Current imaging mode data
- 2 Image orientation marker
- 3 Text display
- 4 Pictograph display
- 5 Calculations menu
- 6 Current measurement/calculation data
- 7 Current patient/exam data
- 8 System status information
- 9 Image depth marker
- 10 On-screen menu selection

Getting Started

- 1 Turn system on.
- 2 Attach transducer.
- 3 Press **Patient** key and complete patient and exam information.
- 4 Press the desired imaging mode key:
 - 2D
 - M Mode
 - Color Doppler
 - Doppler
- 5 Press the **2D** key to return to 2D imaging.

Mini-Dock Connections

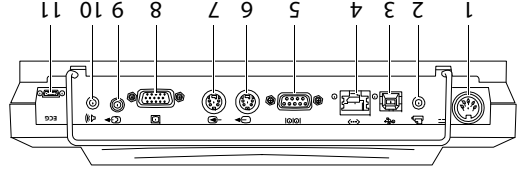

- 1 Power in
- 2 Printer
- 3 USB
- 4 Ethernet
- 5 RS-232
- 6 S-Video out
- 7 S-Video in
- 8 DVI or RGB video out
- 9 Composite video out
- 10 Audio out
- 11 ECG/Footswitch

MicroMaxx: Quick Start Cards

2D and M Mode Imaging









2D

MicroMaxx automatically defaults to 2D imaging.

M Mode

- 1 Press **M Mode** key for M-line.
- 2 Press **M Mode** key again for M Mode trace.







On-screen menu items for these modes

Control		Description
Optimize		Select Gen, Res, or Pen to optimize resolution and penetration.
Dynamic Range		Adjust gray scale range to control image contrast: +3, +2, +1, 0, -1, -2, -3.
Dual		Toggle between full and side-by-side 2D images (2D only).
Clips		Display the clips menu (optional feature).
Biopsy		Display biopsy guidelines (2D only; dependent on transducer type).
Orientation		Select image orientation: Up/Right, Up/Left, Down/Left, and Down/Right.
Brightness		Adjust display brightness: 0-10.
SonoRES SonoMB		Select S to turn on SonoRES. MB is on when SonoMB is available. When both 2D image enhancements are available, SonoRES and SonoMB share the same on-screen menu.
Sweep Speed		Select desired M Mode sweep speed: slow, med, fast.
ECG		Display the ECG trace (optional feature).

Color Doppler Imaging

- 1 Press **Color** key for color power Doppler (CPD) or color imaging (dependent on transducer and exam type).
- 2 Select **Color** or **CPD**.
- 3 Use the **Touchpad** to position the region of interest (ROI) box.

On-screen menu items for this mode











Control		Description
Color or CPD		Select Color or CPD.
Flow Sensitivity		Select flow sensitivity: low, medium, or high.
PRF Scale		Select pulse repetition frequency.
Wall Filter		Select wall filter setting: low, med, or high.
Steering		Select correct steering angle for pulsed wave (PW) Doppler: -15, 0, or +15 degrees (L38e and HFL38 transducers only).
Variance		Turn variance option on and off (cardiac only).
Invert		Select to switch the displayed direction of flow.

MicroMaxx: Quick Start Cards

PW or CW Doppler Imaging

- 1 Press **Doppler** key for the D-line.
- 2 Select **PW/CW** to toggle between PW and CW Doppler (cardiac only).
- 3 Use the **Touchpad** to position the D-line.
- 4 Press **Doppler** key again for Doppler trace.

On-screen menu items for this mode

Control		Description
Angle Correction		Select to adjust angle correction: 0, -60, or +60 degrees.
Gate Size		Select the desired gate size (varies by transducer and exam type).
TDI		Turn tissue Doppler imaging (TDI) on or off (PW Doppler cardiac only).
Steering		Select correct steering angle for pulsed wave (PW) Doppler: -15, 0, or +15 degrees (L38e and HFL38 transducers only).
Scale		Select the scale/pulse repetition frequency (PRF) setting.
Line		Adjust the baseline position.
Invert		Select to vertically flip the spectral trace.
Volume		Adjust Doppler speaker volume to increase or decrease: 0 to 10.
Wall Filter		Select wall filter setting: low, med, or high.
Sweep Speed		Select sweep speed: slow, med, or fast.
Live Trace		Display a live trace of the peak or mean.

Measurements

- 1 From the imaging mode, press the **Freeze** key.
- 2 Press the **Caliper** key.
- 3 Perform one of the following measurements:
 - Distance
 - Area
 - Circumference

Calculations

Calculation packages vary depending on exam type and transducer.

- 1 From the imaging mode, press the **Freeze** key.
- 2 Press the **Calcs** key.

Calculations Package	Exam Type	Transducer
Cardiac	Crđ	P10, P17, TEE
Gyn	Gyn	C60e, ICT,
IMT	IMT	HFL38, L38e
OB	OB	C60e, ICT, P17
Percent Reduction	Abđ, Hep, IMT, Msk, SmP, Vas	C60e, HFL38, L38e, P10, P17, SLA, SLT
Transcranial Doppler	Orb, TCD	P17
Vascular	Vas	HFL38, L38e, P10, SLA
Volume	Abđ, Bre, Gyn, Hep, Msk, Neo, Nrv, SmP, Sup, Vas	C60e, HFL38, ICT, L38e, P10, P17, SLA, SLT
Volume Flow	Abđ, Hep, Vas	C60e, HFL38, L38e, P10, P17, SLA, SLT



P06435-07

